

# iRV Technologies

## Operation Manual

AM/FM/CD/DVD/MP3/MP4

Digital 2.1 Surround Sound-Optical SPDIF Audio Input

 Bluetooth



iRV 34

# Contents

Safety Guidelines	
Important safety instructions	
Safety compliance	2
Warnings	2
iRV technologies	3
iRV 34 Features	5
Radio Operation	9
DVD/CD/MP3/MP4 Operation	12
App Operation	13
Bluetooth Syncing	14
Remote Control Guide	15
System Setup	18
Language	19
Audio	20
Speaker setup	20
Wiring Diagram	21
Troubleshooting	22
iRV 34 Specifications	23



**WARNING** - To reduce the risk of electrical shock, do not remove cover (or open unit). **NO USER SERVICEABLE** parts are inside. Refer servicing to **QUALIFIED SERVICE PERSONNEL**.

The design and manufacture of this player takes personal safety into consideration. However, any improper operation may result in electric shock, fire, or other hazard.

**DO NOT** open the cabinet by yourself to prevent electric shock. Please contact a professional technician to perform any service needed. Please use only components recommended by factory when replacement is necessary.

Please turn unit off when not in use. Use a dry, soft cloth to clean face with the system turned off.

**PRECAUTION** - Moisture may cause the lens on loader in this unit to malfunction. To remedy the problem, turn unit on, eject disc and run 1-2 hours to vaporize moisture inside the unit. Do not repeatedly turn unit off and on. After turning unit off wait 10 seconds before turning on again. Do not use broken, scratched, or twisted discs in player. This could result in damage to the unit. Use only 5", 12cm discs in this unit.

# iRV Technologies

## iRV 34

### CD/MP3/MP4/DVD Disc Player

Compatible with standard size CD, MP3, MP4 and DVD discs (4.75" or 12cm). The iRV 34 is designed to read standard DVD, MP3, MP4, CD, CD-R, CD-RW, JPEG-CD Disc. Because of variations in recording methods some discs may not play on this unit. This unit will play region 1 DVD's (USA and Canada).

### USB / SD Card

This unit allows users to play files stored on both USB and SD cards including MP3 music, MP4 short video clips and JPEG photo files. The USB port will also charge many devices like iPods and MP3 players.

### Built-In AM/FM Tuner

27 preset FM stations and 18 AM stations available to select.

### HDMI

2 HDMI input and 1 HDMI output.

HDMI output with ARC function.

#### Bluetooth Link

This unit contains Bluetooth technology enabling secure, wireless connections between portable and fixed devices.

The iRV 34 Bluetooth link also enables handheld control of streaming music from users wireless device play list.

This unit supplies quality high power audio and video outputs to three different zones. Zone 1 receives 2.1 surround sound. Zone 2 receive standard stereo audio. Zone 3 has the function of independent control.

This unit has 1 Video Input, 2 Video outputs, 3 Audio inputs, 1 Digital/Optical input to allow users to enjoy entertainment from other sources such as Satellite Radio, VCR's, Digital Cameras, Video Game for iPods and MP3 Players.

These sources must be connected through the inputs on the unit or through additional accessory wall plates.

*\*NOTE: The Digital Optical input is used to enable digital audio from A/V components with digital optical output.*

#### Clock

This unit has a built in clock that can display the time when any button is pressed and a sleep timer that turns off the radio for you.

#### APP Control

This unit can be controlled by APP, Support iPhone 4S+ and Android 4.3+.

# iRV 34 FEATURES

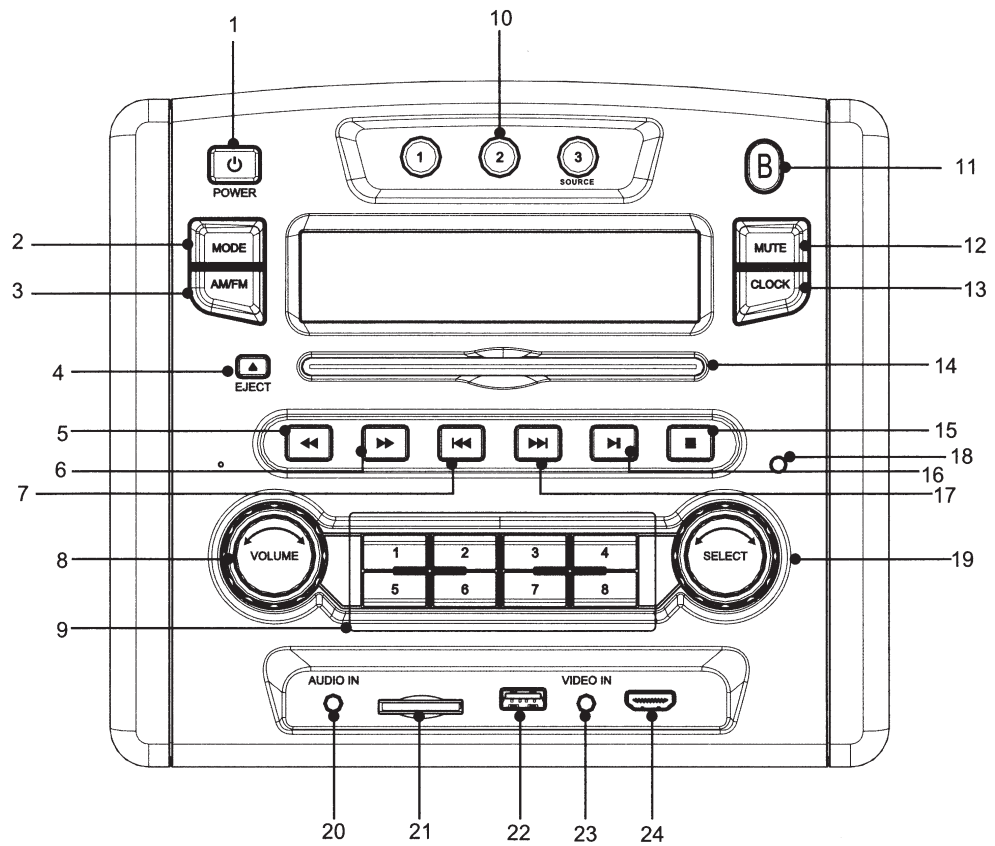

## iRV 34 FEATURES

- 1 **POWER**  
Turns the power on and off.  
Note: Pressing and Holding the POWER button for 5 seconds will re-boot the radio and reset all defaults. It will leave the radio off. Press the on button to continue operation.
- 2 **MODE**  
Select between Radio/DVD/USB/SD/BT/F-AV IN/TV audio/FR-audio/R-AUX1/R-AUX2/DOT-DCC in/R-HDMI IN1/R-HDMI IN2/F-HDMI IN.
- 3 **AM/FM**  
Allows you to select FM1, FM2, FM3, AM1, or AM2. Each band can be auto programmed with 8 station presets. 24 total preset stations for FM and 16 total preset stations for AM. (See FFWD or FRWD Radio Mode for auto scan features.)
- 4 **EJECT**  
Press to eject a Disc from your iRV 34 built in player.
- 5/6 **F. RWD ◀▶**  
Radio Mode: Press to auto scan and memorize band preset stations. Scan through all lower preset stations.  
Disc Mode: Select different levels of fast reverse.
- 7/17 **FWD and RWD buttons ◀▶**  
Radio Mode: Press to select next frequency, higher or lower.  
DVD Mode: Moves menu selection.
- 8 **VOLUME**  
Increase or decrease the volume in all rooms where sound is being played.
- 9 **1-8**  
[1],[2]....[8] number buttons are used to enter number, e.g. No. of track, DVD chapter No., time data, etc.
- 10 **SPEAKERS 1-2- 3**  
Turns sound on or off in corresponding ZONE 1, 2 or 3. Push and hold Zone 3, you can enter into/exit from the operation menu.
- 11 **Bluetooth**  
Press this to enable Bluetooth connectivity.
- 12 **MUTE**  
Push to mute, push again to unmute.

## iRV 34 FEATURES

- 13 **CLOCK**  
Press this to see time. This function works in all modes and even when the unit is turned off. Press to change to the clock display. Press and hold to turn the display indication and button illumination off or on.
- 14 **CD/MP3/MP4/DVD Disc loading slot**  
Insert a disc to play. Compatible with standard size CD, MP3, Mp4 and DVD discs (4.75" or 12cm) . The unit is designed to read standard CD, MP3, MP4, DVD, DVD+R, DVD-R Disc. Because of variations in recording methods some discs may not play on this unit. This unit will play region 1 DVD's (USA and Canada).
- 15 **STOP**  
Press to stop playback of disc. Press Play to continue the playback
- 16 **PLAY / PAUSE ►||**  
Press to play disc or pause playback of disc.  
During radio mode:(Auto-storage /Preset scan)  
1) When press , the radio searches from the current frequency and checks the signal strength level until 8 station are found. And then the 8 stations frequency are preset to the corresponding preset memory numbered
- 17 **PRESET**  
bank. When press and hold for more than 1second,The auto-storage operation is implemented in the each selected band. When the auto-storage operation is finished, the radio execute the Preset scan.
- 18 **IR**  
Infrared remote sensor.
- 19 **SELECT**  
When reading the USB, MP3, CD discs, such as rotate this knob can choose to play, and then click on the confirm this knob.
- 20 **AUDIO IN**  
Audio input from Mp3 or iPod player,This is a 3.5mm input.
- 21 **SD Card slot**  
Reads media stored on SD cards.The Unit supports SD cards with up to 32GB capacity.The SD card must be formatted to be FAT or FAT32.

## iRV 34 FEATURES

### 22 USB port

The USB port allows users to play files stored on USB and USB attached media devices, including music, video and photo files. The unit supports USB flash drives with up to 1TB capacity. The USB drive must be formatted to be FAT or FAT32.

### 23 VIDEO IN

Video input from iPod player. This is a 3.5mm input.

### 24 HDMI IN Port

HDMI connection HDMI cable. HDMI 3 input, HDMI 3 output, DVD and HDMI output.

iRV 34 DISPLAY SCREEN

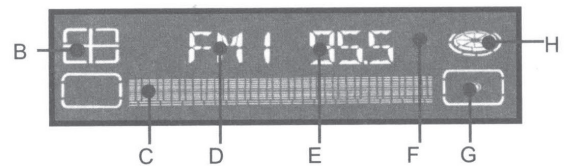

B STEREO

C VOLUME

D BAND

E FREQUENCY

F PRESET

G EQ SETTINGS

H REMOVABLE MEDIA



## RADIO OPERATION

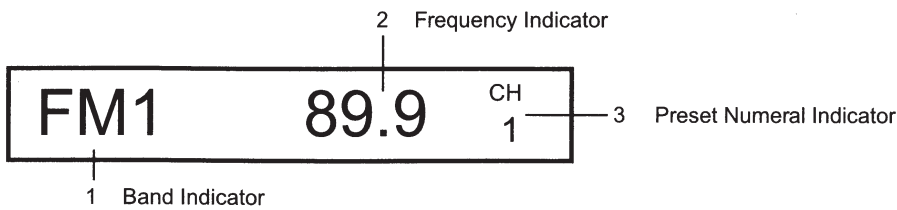

### POWER



Turns the power on and off.

Press for power "On or Off"

### Radio Reception Mode

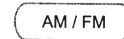
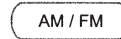

Press to access the radio, press to activate desired band: AM1, AM2, FM1, FM2, FM3.

Activate radio

Press for desired Band

### Manual Tuning

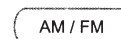

backward

forward

Select knob

Select Band, Select single arrowed button to move the channels down or up.

Select Band

Chanel Down

Chanel Up

### Auto Search Tuning

Push to auto search for an available station at a higher or lower frequency. When this function is selected the unit will stay at the selected station until another function is selected.



Select Band

Auto Search Down

Auto Search Up

### Manual Frequency Presets

Select Band, Select desired frequency, Hold desired numeral for 3 seconds. Frequency is set. Repeat to change. Frequency can be preset for AM1, AM2, FM1, FM2, FM3.

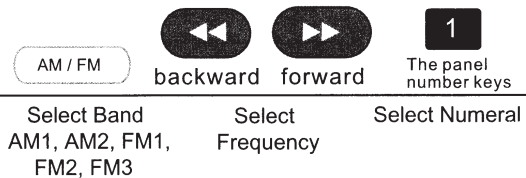

Select Band  
AM1, AM2, FM1,  
FM2, FM3

Select  
Frequency

Select Numeral

### Recall Frequency Presets

Select Band AM1, AM2, FM1, FM2, FM3, then select desired numeral

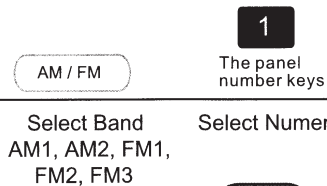

Select Band  
AM1, AM2, FM1,  
FM2, FM3

Select Numeral

### Automatic Store / Preset Scan

#### A. Automatic Scan & Store

While listening to the Radio, Long press the "▶||" button, The receiver will automatically scan and save the station listening to.

#### B. Scan Saved Stations

Short press the "▶||" button once to perform the scanning functions.



Play/pause

## RADIO OPERATION

### Auto Best Station Memory

While in FM1 if you press the NEXT button the radio will start scanning from low to high frequencies., or PREVIEW button the radio will start scanning from high to low frequencies. Each strong station found will be stored in a preset button until all 24 FM presets are full. You can also do this with the AM band. There are 16 presets available for the AM band.

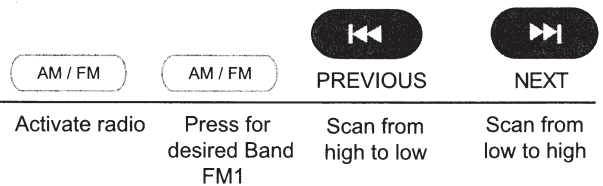

### Clock Setting the time

Press and hold the CLOCK button for 3 seconds. Hour will flash. Use the SELECT KNOB to set correct hour. Press SLECET button move to minutes. Minutes will flash. Use the SELECT KNOB to set correct minutes. Press the CLOCK button to memorize

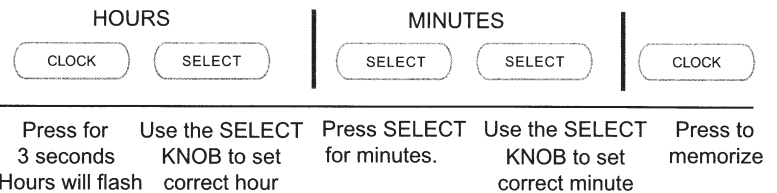

## DVD/CD/MP3/MP4 OPERATION

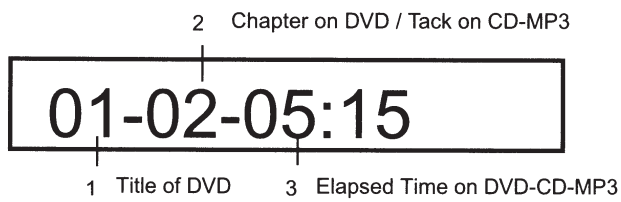

### Fast Reverse / Fast Forward

2X, 4X, 8X, 20X To select a normal speed, push the PLAY button.



F RWD

Push the  
Fast Rewind button  
to rewind DVD



F FWD

Push the  
Fast Forward button  
to advance the DVD

### Previous / Next

Select previous or next track.



PREVIOUS



NEXT

## DVD/CD/MP3/MP4 OPERATION

### To Load USB and SD Media



Insert USB device or SD card into proper socket on the front of the radio to begin playing media. To view, navigate and select between music and video/photo media the TV or Monitor must be on and set to AV mode. Use remote NAVIGATION buttons to navigate on screen menu.

Because of variations in 3rd party recording methods some discs, USB devices or SD cards may not play on this unit. Also, the SD and USB ports are capable of playing short video clips. Long playing video files may experience buffering delays and video freeze if viewing is attempted through these ports. Bluetooth is not video enabled and will not play video files.

## APP OPERATION



On Your iPhone or iPad:

- Click on 'App Store'
- Click 'Search' at the bottom of the screen
- In the search bar, type either iRV34 or iRV66

\*If using iPad, make sure to click the 'iPhone apps' option

\*Please note that there is no space in iRV34 or iRV66 for either type of device.



On Your Android Device:

- Click on 'Google Play'
- In the search bar, type either iRV34 or iRV66 at the top of the screen

## Bluetooth PAIRING

Pairing the iRV 34 with a Bluetooth device

With the iRV 34 powered on Press the button marked "Bluetooth " to enter Bluetooth setup. The iRV 34 screen will report "BT NO LINK" until a Bluetooth device is successfully paired with the iRV 34.

The iRV 34 will send a pairing request to the Bluetooth device that reads "IRV 34" request to pairing with your cell, please confirm the numeric code "XXXXXX" shows on the "IRV 34", click "pairing", the iRV 34 screen will report "BT LINK" to confirm a Bluetooth devices is successfully paired with the iRV 34.



Press the  
"Bluetooth "  
button to enter  
setup



Enter a numeric  
PassKey

## REMOTE CONTROL Guide

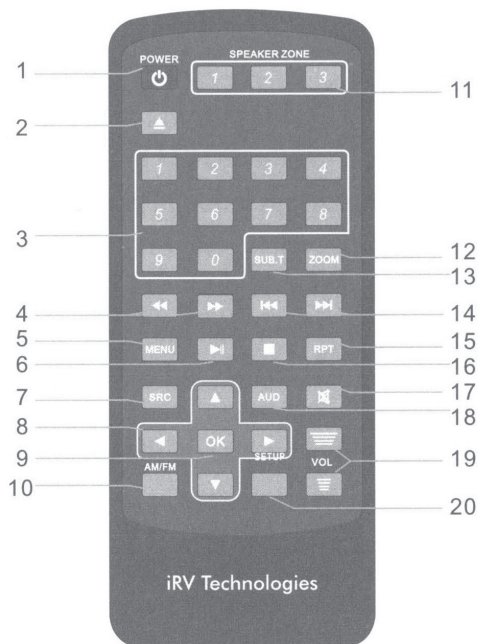

### 1.Power

Turns the power on and off.

### 2.Eject

Push the button once, the disc will be ejected from the slot, press it again and the disc will be taken back into the slot.

### 3.0-9 NUMBERS

**Radio Mode:** You can select one of the 9 stored stations on each band by pressing any one of the number buttons (1-9).

**Disc Mode:** You can select any track directly by using the number buttons (0-10+). Example: If you want track number 25. Consecutively press the number 2, then 5 and track number 25 will begin to play.

### 4.FAST REVERSE / FORWARD

Press to select different levels of Fast Reverse or Fast Forward. Press Play to resume selection.

### 5.MENU

DISC only. for DVD title menu and root menu.

## REMOTE CONTROL Guide

### 6. PLAY / PAUSE

Press PLAY/PAUSE button to suspend the playback of CD, MP3, MP4, VCD and DVD media. Press it again to return to normal playback mode.

### 7. MODE

Select between Radio/DVD/USB/SD/BT/F-AV IN/TV audio/FR-audio/R-AUX1/R-AUX2/DOT-DCC in/R-HDMI in1/R-HDMI in2/F-HDMI in.

### 8. NAVIGATION BUTTONS

Press the appropriate button to move around any menus that are selected on screen. Center button is the select / enter button.

### 9. OK

Use to finalize selection.

### 10. AM/FM

Allows you to select FM1, FM2, FM3, AM1, or AM2. Each band can be auto programmed with 8 station presets. 24 total preset stations for FM and 16 total preset stations for AM. (See FFWD or FRWD Radio Mode for auto scan features.)

### 11. ZONE 1, 2 and 3

Turns sound on or off in the corresponding ZONE 1, 2 or 3. Push and hold Zone 3, you can enter into/exit from the operation menu.

### 12. ZOOM - DVD Only

DVD, VCD: Press the ZOOM button once to enable 2X zoom mode. Pressing the ZOOM button repeatedly moves the zoom mode through 3X, 4X, 1/2X, 1/3X, and 1/4X zoom levels. Press ZOOM again to exit the zoom mode.

### 13. SUBTITLE (SUB-T)

DVD only. Returns to previously selected tracks. Press to select language or to turn off subtitles. Press and hold for 3 seconds to return to previous chapter.

### 14. PREVIOUS / NEXT

**Radio Mode:** Press to select higher or lower stations.

**Disc Mode:** Press to select previous or Next track or chapter.

Pushing the Previous button, the unit will play the disc from the beginning of the previous track.

Pushing the Next button, the unit will play the disc



## REMOTE CONTROL Guide

from the beginning of the next track.

### **15.REPEAT**

DVD Mode: Press REPEAT to repeat the current track being played. Press it twice to repeat playing all of the tracks. CD, MP3, VCD

Mode: Press REPEAT to repeat the current track being played. Press it twice to cancel the repeat function.

### **16.STOP**

DVD, VCD, CD: Press STOP to suspend playback mode. STOP will display on the TV Screen.

Pressing STOP a second time will end all disc playback.

### **17.MUTE**

Press the MUTE button to turn off the sound in all ZONE 1, 2, and 3. Press it again to resume the previous sound levels.

### **18.AUDIO - DVD Only**

Adjusts the surround sound mode as well as selects the language. Must be set before play.

### **19.VOLUME**

Press the VOLUME (+ or -) button to increase or decrease the volume level respectively.

### **20.SETUP**

Press for DVD setup menu, Menu navigation screens will appear on Video Monitor.

## SYSTEM SETUP

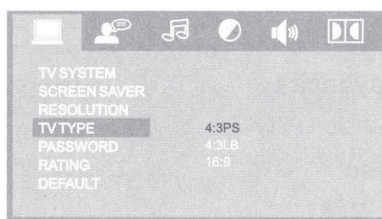
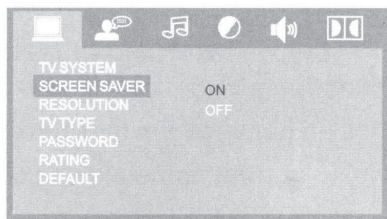
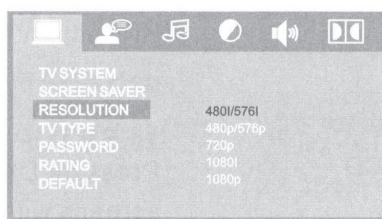
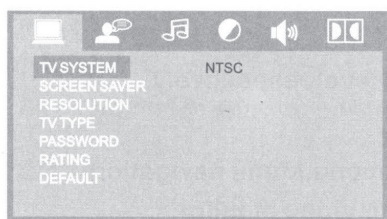

Press the "VIDEO" button to activate the System Setup on screen display Video Monitor Only menu .

Use the NAVIGATION buttons to navigate the following OSD menu options.

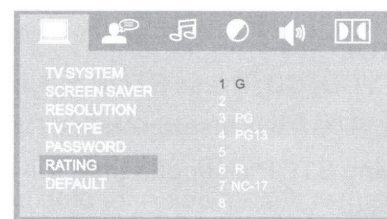

# LANGUAGE SETUP

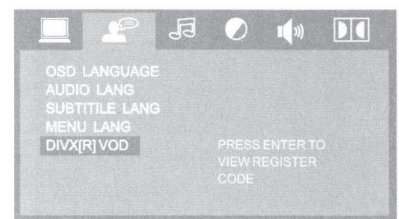
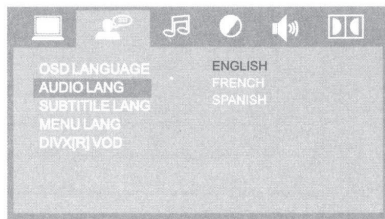
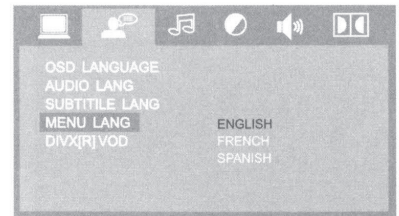
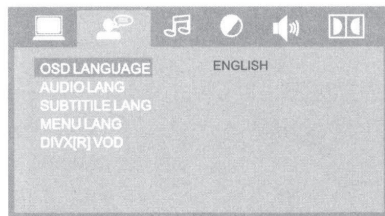

## AUDIO SETUP



## SPEAKER SETUP

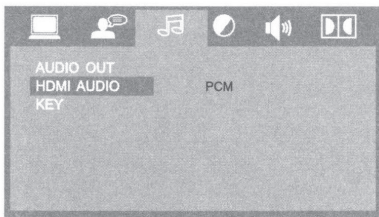
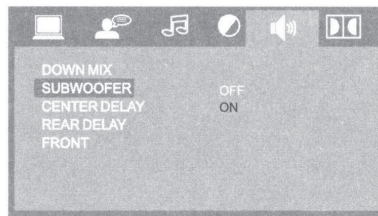

# WIRING DIAGRAM

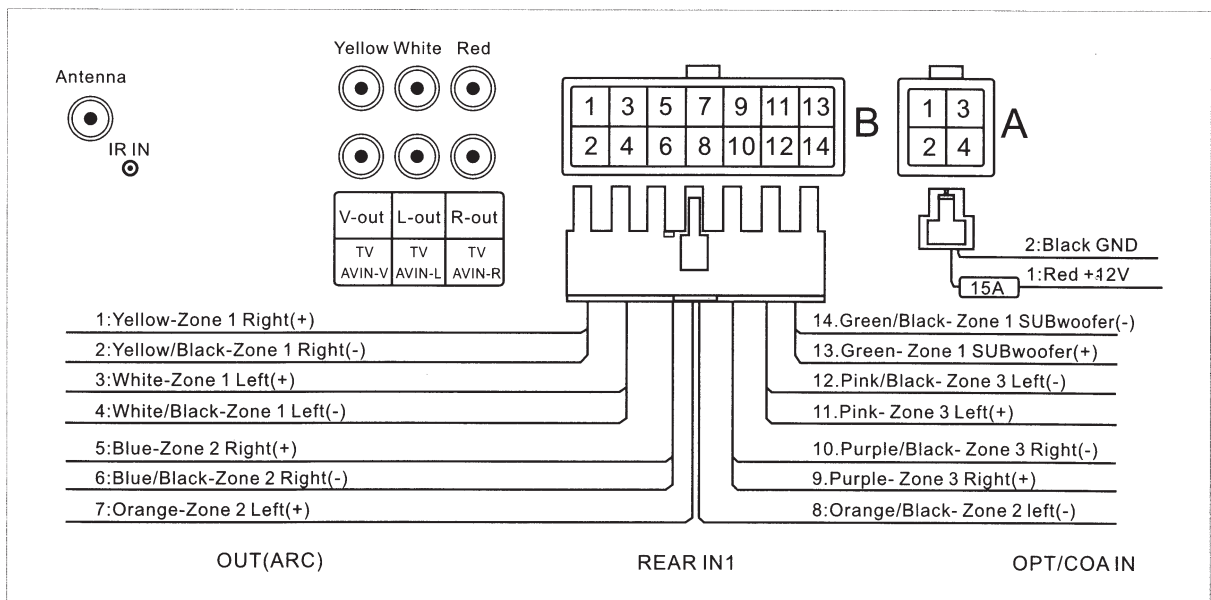

## TROUBLESHOOTING

### No Power

Check and make sure whether the fuse is blown, replace fuse with proper value if necessary.

Some errors occur in the LCD or no function when pressing the button.

Turn off the unit and restart the unit again. Use Factory Default Restart.

### Poor radio reception or static.

Antenna may not be the proper length. Make sure the antenna is fully extended. Antenna may be broken. Replace antenna.

The broadcast signal is too weak.

The antenna is poorly grounded. Check and make sure the antenna is properly grounded at its mounting location.

### Disc cannot be loaded

Disc is loaded in the machine. Clear the disc by pressing eject

### No Picture.

The Video line from the main unit to the TV is not connected properly. Check connections.

Improper setting of the TV SYSTEM. Set the TV SYSTEM to "NTSC", according to the connected television.

### Disc error appears.

The disc may be damaged or dirty.  
Clean disc and retry.

### When there is no color on video.

Turn off the unit and restart the unit again.  
Use Factory Default Restart.

### FACTORY DEFAULT RESTART

Press and hold POWER button for 5 seconds - Unit will shut off. Restart unit by pressing the ON button. Factory defaults will be reset with this type of restart.

### NOTE:

If any of the problems persist after check list has been made, consult your nearest service dealer.

Never attempt to disassemble your unit by yourself.

## iRV 34 SPECIFICATIONS

Overall Dimensions	9-5/8" (W) x 8-1/2" (H) x 6" (D)
Mounting Dimensions	7-3/4" (W) x 7-1/2" (H) x 5" (D)
Net Weight	5lbs (2.3Kg)
Voltage	12V DC Negative Ground (11.0V - 15.0V allowable)
Maximum Current Consumption	9A
Total Continuous Power Output	50W
Load Impedance	4 $\Omega$ (4-8 $\Omega$ allowable)
Total harmonic distortion	Typical 0.02% Maximum 0.3%
DVD Deck Section, Discs Played	DVD, MP3, MP4, CD, CD-R, CD-RW, JPEG-CD
Video System	AUTO / PAL / NTSC
Video Section	4:3 Letter Box and 4:3 Pan Scan, 16:9
Video Output level	1.0Vp-p +/-0.2V 75ohms
AM Tuner Section, Frequency Range	530 - 1710KHz (U.S.A.)
FM Tuner Section, Frequency Range	87.5-107.9MHz (U.S.A.)
Bluetooth	Version 2.0, Class II
Advanced Audio Distribution	OPP, OBEX, SPP, A2DP, AVRCP

