

# 3D Holographic Display

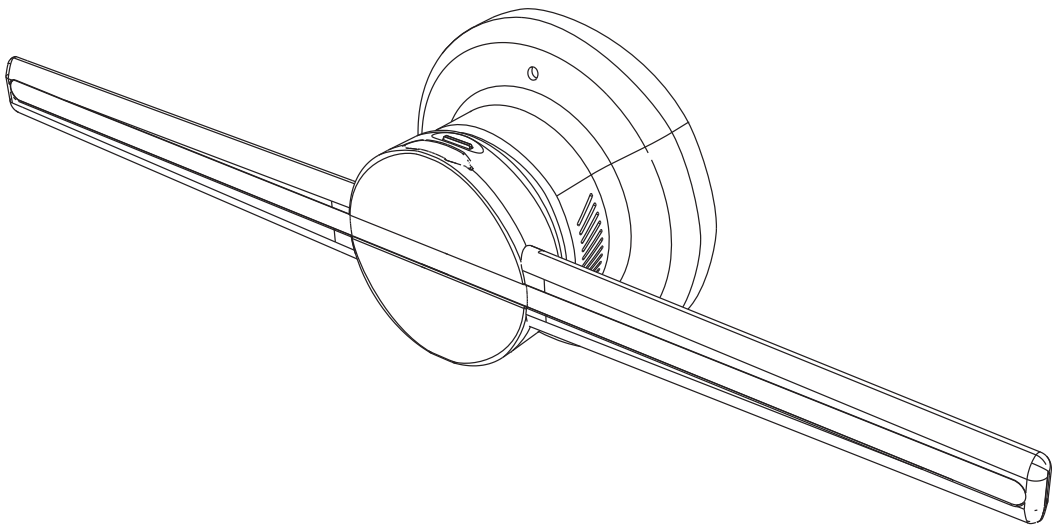

Instruction Manual

## OPERATION MANUAL

Product Name: 3D Holographic Display		
Feature		
1	Item	3D Holographic Display
2	Model	HR-AD01
3	Input Power	AC100~240V 50/60Hz
	Output Power	12V 3000mA
4	Rated Power	20W
5	Resolution(Pixel)	640*640
6	Visual Angle	160
7	Lamp Beads Life Time	100, 000 hours
8	LED Quantity	320 Pcs
9	Support Format	mp4, avi, rmvb, mkv, gif, jpg, png
10	Storage	32GB Maximum
11	Support	TF Card & WIFI
12	Remote Control	Turn on/Turn off, Adjust Brightness, Play Mode
13	Shell Material	Aluminum Alloy, ABS, PC
14	Work Temperature	-10°C~40°C
15	Size	430mm*120mm*88mm

## OPERATION MANUAL

Function		
1	APP Function	Wifi remote data transmission
		Adjust brightness
		Cycle play
		APP select the next and previous page
		File format conversion
2	APP Version	IOS
3	Data Storage	TF Card
4	PC Software Function	Wifi remote data
		File format conversion
5	PC Operation System	Win7, Win8, Win10
6	Remote Controller	Turn on/turn off
		Adjust brightness
		Cycle play
		Select next and previous page
7	Indication light	Standby
		Power on
		Mode switch

Accessories Illustration

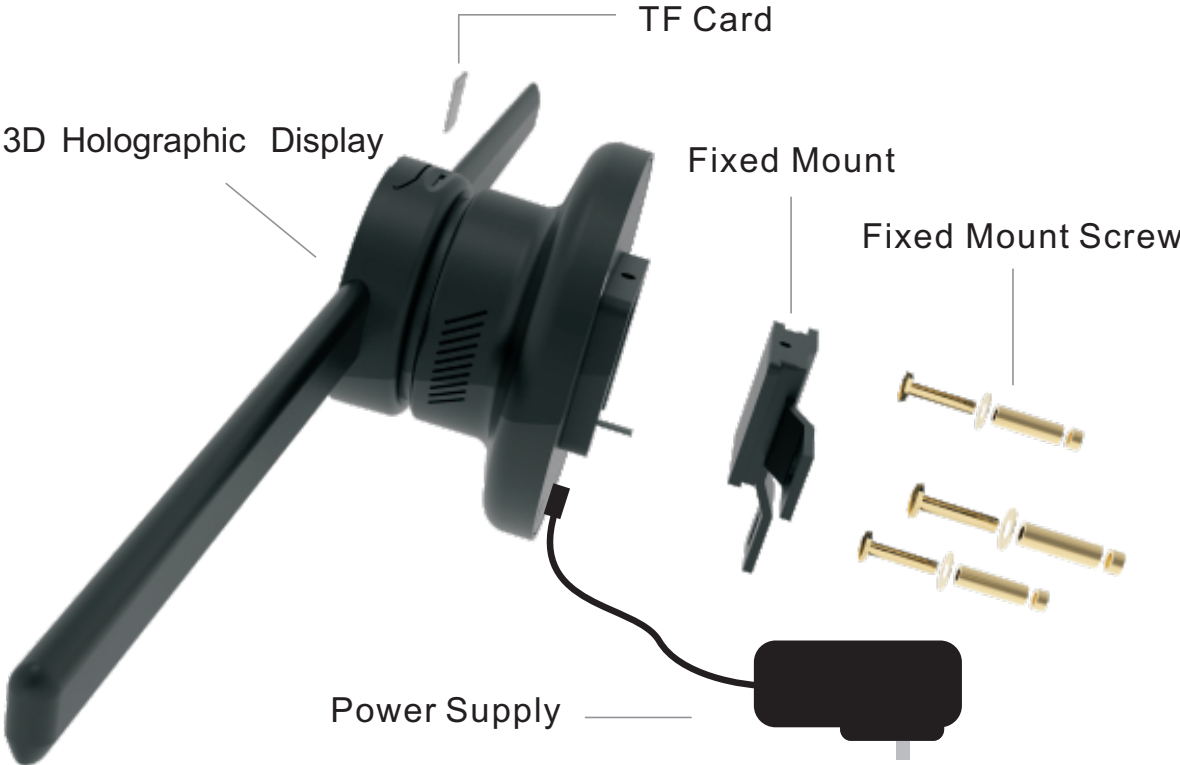

**Remote Controller**

(Increase brightness/Decrease brightness) Temporarily unavailable

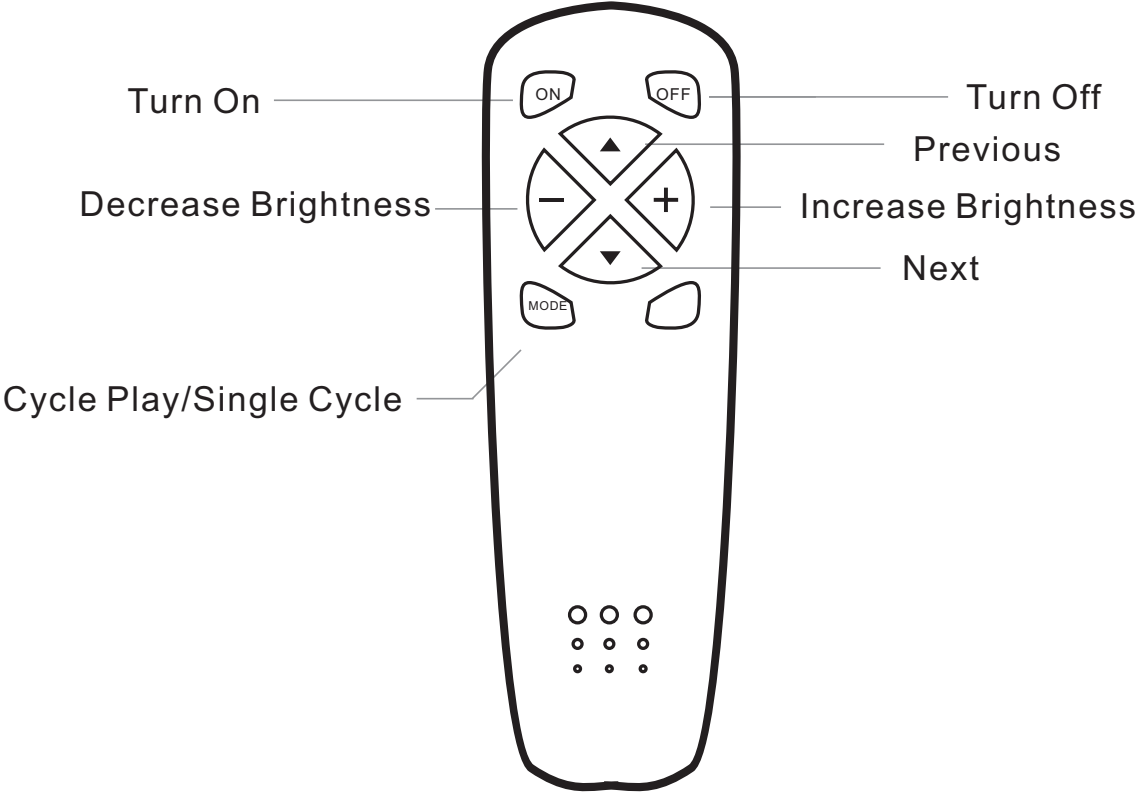

This APP is a software for 3D Holographic Display

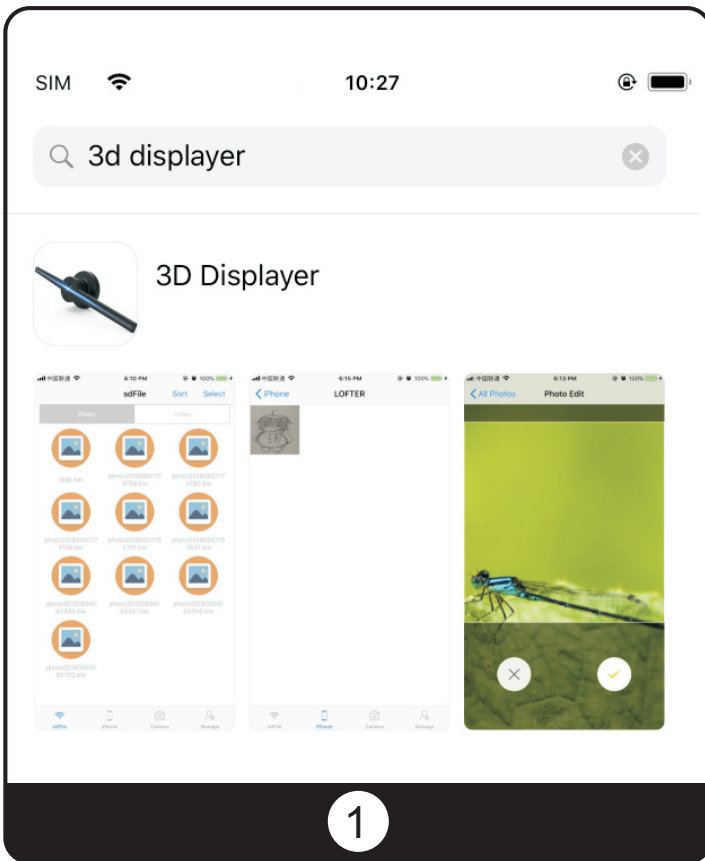

### The main functions

- User can take a photo or a video and then transfer it to Display by WIFI.
- User can also view the files stored in the advertiser and control them to be Display by displayer.
- User can manage the files stored in the Display, including upload and delete.

#### 1.Install App

- In the App Store, search "3D Displayer" and install it.

## This APP is a software for 3D Holographic Display

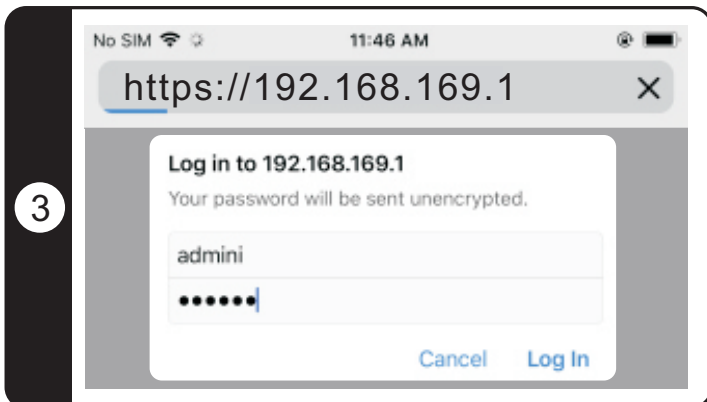
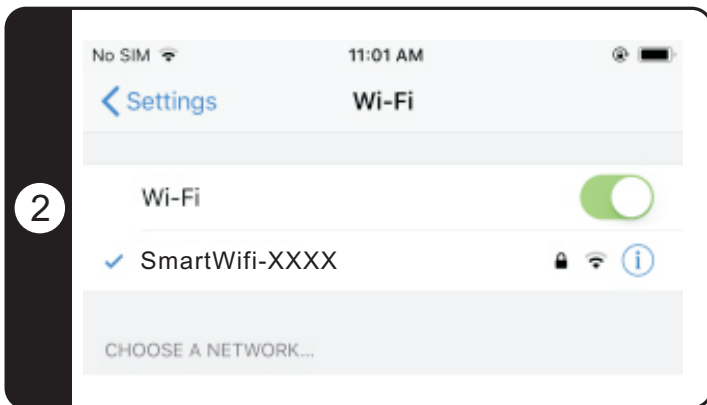

### 2.Connect to 3D Displayer

In the iOS WLAN setting, select the wifi: SmartWifi-XXXX. The default password is: "12345678".

### 3.Change WiFi user name or password

After connecting the 3D Holographic Display with WIFI, start the web browser and type "192.168.169.1" for WiFi settings. "Account:admin,Password:admin".

This APP is a software for 3D Holographic Display

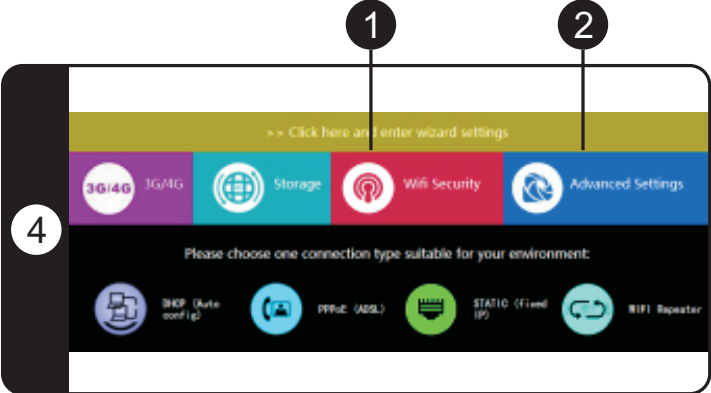

4. Wifi setting interface

- 1. WiFi account password settings
- 2. Language switching

5. Wifi Setting

- 1. WiFi user name
- 2. WiFi encryption
- 3. WiFi encryption password





APP for iPhone

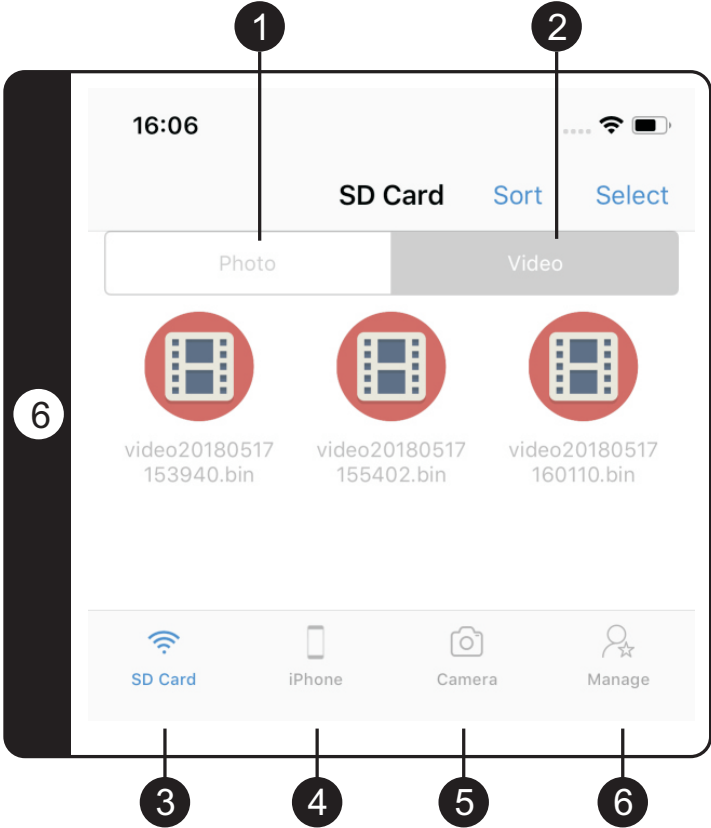

**6 . APP for iPhone user interface**

- 1. Access the files stored in the 3D Display Press "SD Card", the files stored in the 3D Display can be accessed. The following list is the photo files.
- 2. And the following list is the video files.
- 3. Access files in the 3D Display.
- 4. Access the Album of iPhone.
- 5. Take photo or video and upload to 3D Display.
- 6. Operate the 3D Display.

### iPhone Upload Files

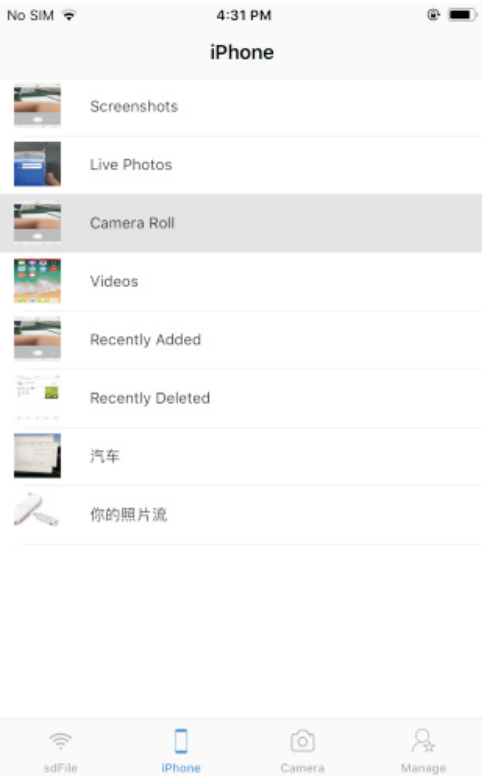

1



2

3

When file is uploading, the 3D Diaplay will be paused

- 1. Access the album of iPhone by press "iPhone" to view the files of the album.
- 2. Cancel.
- 3. Select photo or video and upload it to 3D Display

## Shoot and upload

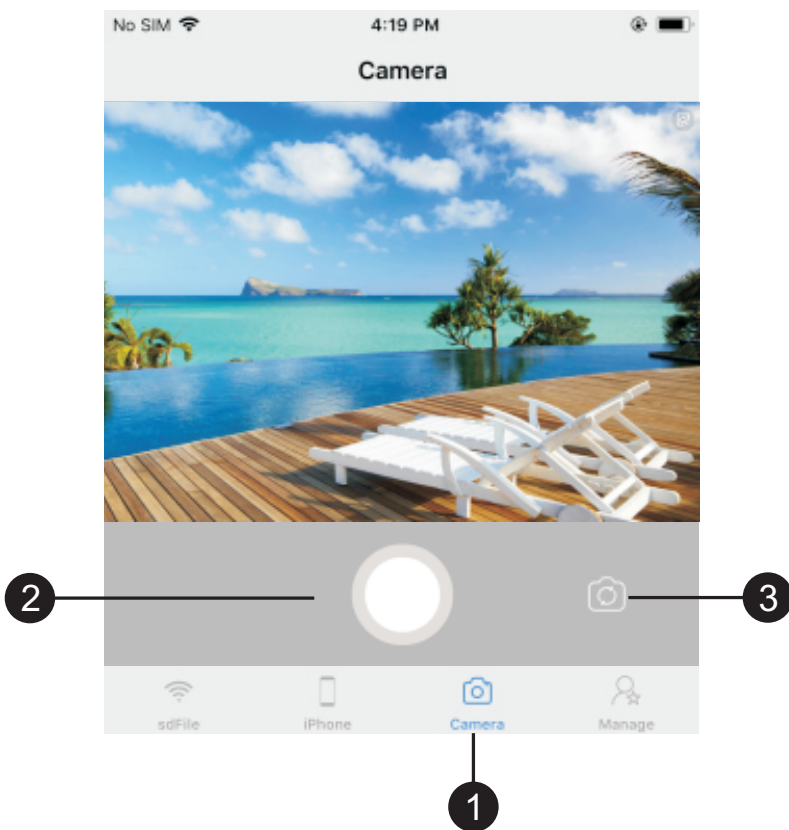

1. Take photo or video and upload it to 3D Holographic Display .
2. Switch camera lens.
3. Click to take photo, long press to take video, video is limited to 15 seconds

### Manage the Files

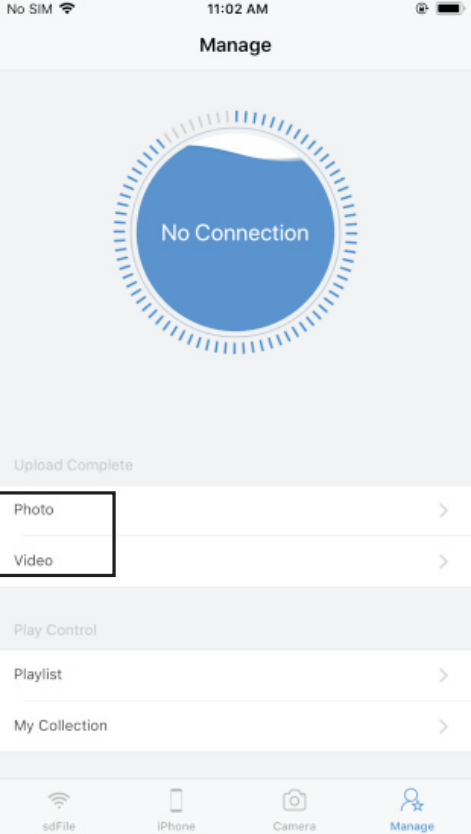

- 1.Upload Photo and Video stored in the 3D Holographic Display.
- 2.The list and order of the file to be displayed.
- 3.Favorite files

Pov Console



3D Holographic Display only support bin format, convert through the supplementary tools of our company. Conversion tool support video format: rm, rmvb, mp4, avi, mkv; image format: bmp. Single file can not be bigger than 2GB, within 4 minutes is the best. Max support 30 frames/second for video/image playing.

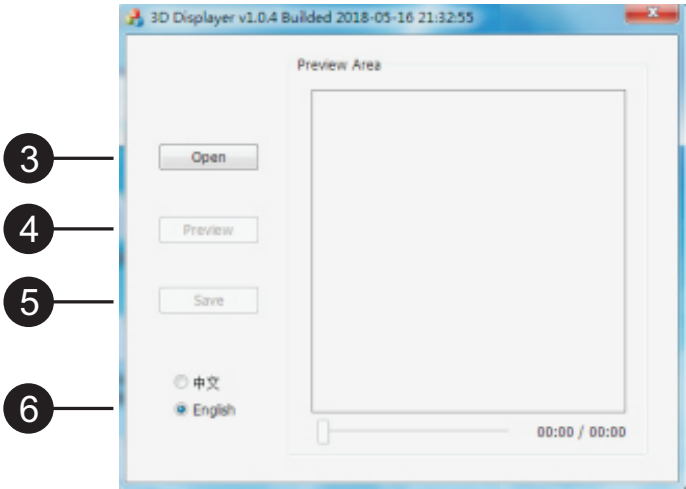

- 1.PC Conversion Tool
- 2.PC Application
- 3.Open File (Image/Video)
- 4.Preview File (Image/Video)
- 5.Save File (Image/Video)
- 6.language Switch

### Precautions



Before using, please check the voltage whether is the same with the 3D Holographic Display voltage or not.



Please do not pull power plug with wet hand to avoid the danger of electrification and electric shock.



Please avoid high temperature, high humidity, acid and alkali oil, insecticidal water and curtain, etc.



Please do not place the blades on the sloping ground to avoid fan tipping.



When the blade assemble is not finished, please do not connect the power supply. Please cut off the power when moving the fan.

### Precautions

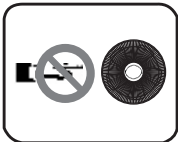

When the blade is running, please do not insert your fingers or sticker into the guard.

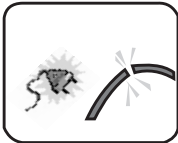

Please check the power cord and the plug before using. If the power supply



soft wire damage, in order to avoid danger it must be changed by the manufacturer, maintenance department or professional staff.



When the person leaves the machine or the machine is not in use, please turn off the power and pull the plug to avoid incidence caused by power failure.



Please do not use any abrasive tools or solvents that will damage the surface of product when clean it. It can wash with detergent, then wipe dry with a clean cloth.

### Precautions



Please do not use water or other liquid to wash electrical components (e.g. power switch, motor, etc.) Electrical components can be cleaned with clean cloth.



It is forbidden to disassemble the product for modification. It is recommended to check and clean the product every year to extend its service life.

### Special Declaration

- 1.This manual has been proofread carefully.
- 2.If the products have some technical improvements in the future, please be well noticed that we will not inform at that time
- 3.If there is any change in the appearance and color of the product, please refer to the physical object.
4. Internal pictures are for reference only.