

---

## 1 Product Name

1.1 The Middle install intelligent LCD Display

1.2 Model:C965

## 2 Suppliers

RisunMotor-Suzhou Bafang

## 3 Electrical Parameters

- ◇ 24V/36V/48V battery supply
- ◇ Rated operating current : 10mA
- ◇ Max operating current : 30mA
- ◇ Off leakage current < 1uA
- ◇ Max output current to controller : 50mA
- ◇ Operating temperature : -30~70℃
- ◇ Storage temperature : -40~70℃

## 4 Dimensions & Material

4.1 Product shell is ABS, transparent window is made with high strength Acrylic, the stiffness equals the tempered glass.

4.2 Dimensions : host/L90mm\*W54mm\*H13.3mm





## 5 Features

- ✧ Suitable for low temperature, Max -30°C.
- ✧ Ergonomic external button design, easy to operate.
- ✧ **Speed display** : AVG SPEED, MAX SPEED, SPEED(Real-time).
- ✧ **Kilometer / Mile** : Can be set according to customers' habits.
- ✧ **Smart battery indicator** : Provide a reliable battery indicator, it will not fluctuate with the motor on/off.
- ✧ **The brightness of the backlight adjustable** : 5-sections
- ✧ **9-level Assit** : 3-level/5-level/6-level/9-level... optional

- ◇ **Mileage indicator** : Odometer/Trip distance/ Riding time
- ◇ **Error code indicator**
- ◇ **Parameter settings** : Multiple parameter can be set through computer USB port, including Assist level / Wheel diameter / Voltage / Speed limit...

## 6 LCD instructions

The figure of LCD display see below:

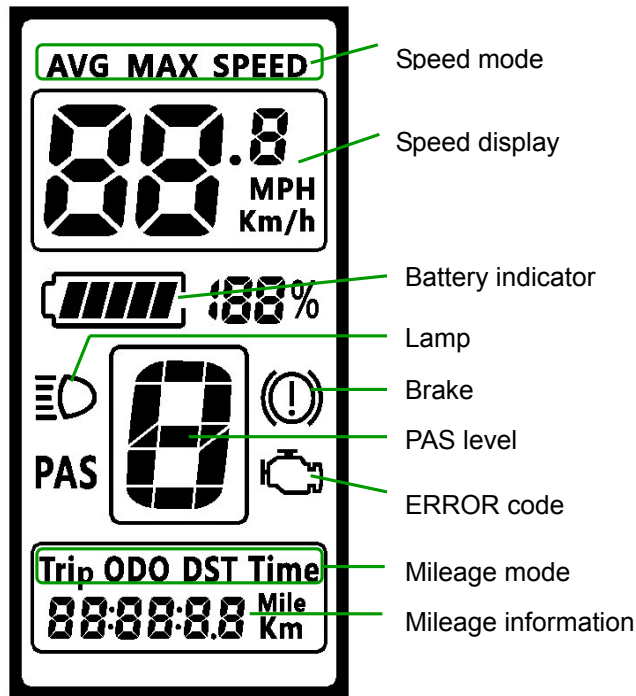

## 7 Functional Description

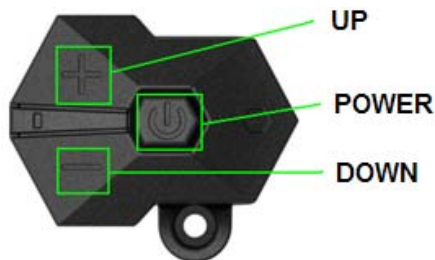

### 7.1 Power On/Off

Press and hold **Power** button for 1 second can turn on/off the display. The Display can

automatically shut down when there is no operate & ride for X minutes ( X could be 0~9 ) .

## 7.2 Assist level operating

Short press **UP/DOWN** button can change the assist level. Top assist level is 9, 0 for neutral. Level quantities can be adjusted according to the customer requirements.

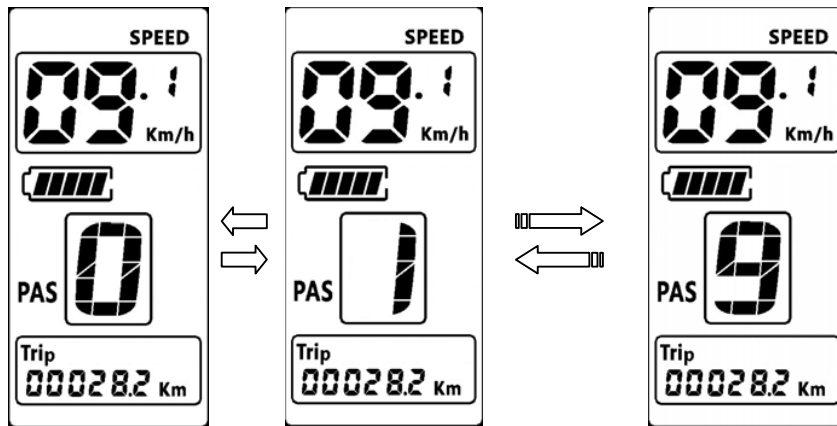

Assist operating

## 7.3 Speed mode switch& Mileage mode switch

Short press **POWER** button can change the speed mode& the mileage mode, **Speed->AVG Speed->MAX Speed->Trip->ODO-> Time.**

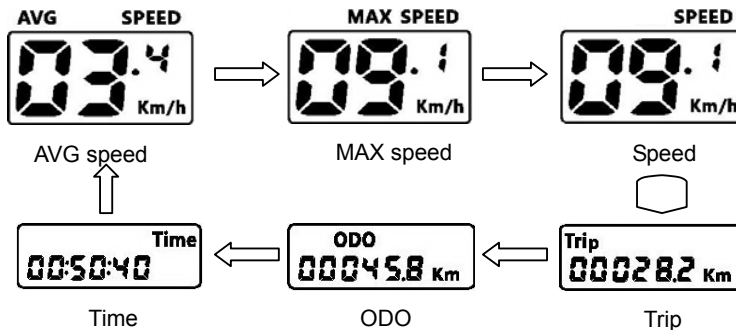

Speed mode switch& Mileage mode switch

\*If there is no operation for 5 seconds, display will return Speed (Real-Time) display automatically.

## 7.4 Headlight/backlight On/Off

Press and hold **UP** button for 1 second can turn on/off the headlight/backlight.

The motor does not work when the battery voltage is low, Display still can keep the headlight on for a while when E-bike is in riding.

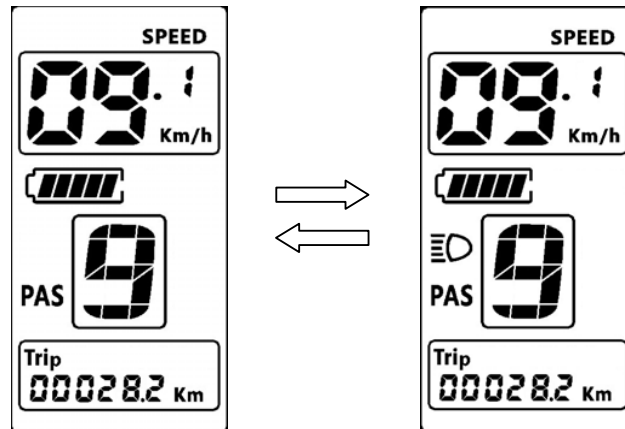

### 7.5 6km walk

Press and hold **DOWN** button for 1 second can get into walk mode, out of the mode when release the button.

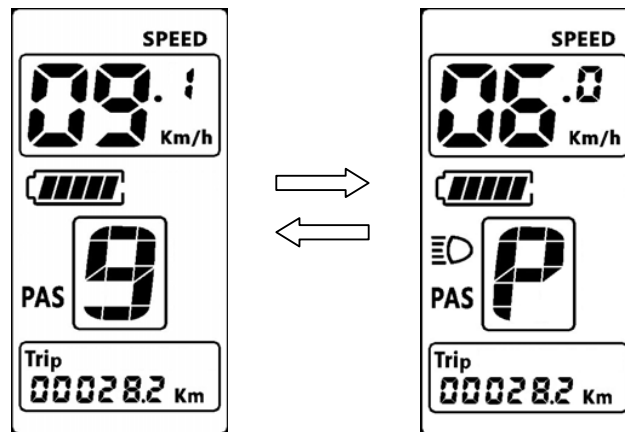

### 7.6 Data cleanup

Press and hold **UP** & **DOWN** buttons together for 1 second can reset several temporary data, temporary data include **AVG Speed / MAX Speed / Trip / Time**.

## 8 Parameter setting

Double press **POWER** button (press interval less than 0.3 second) can get into parameter setting state, the parameter twinkles. Short press **UP/DOWN** buttons to change the parameter value, short press **POWER** button can switch to the next parameter. Double press **POWER** button (press interval less than 0.3 second) can quit from the parameter setting state. The meter will automatically quit the parameter setting state when there is no operation for 10 seconds.

The order of parameters is as follows.

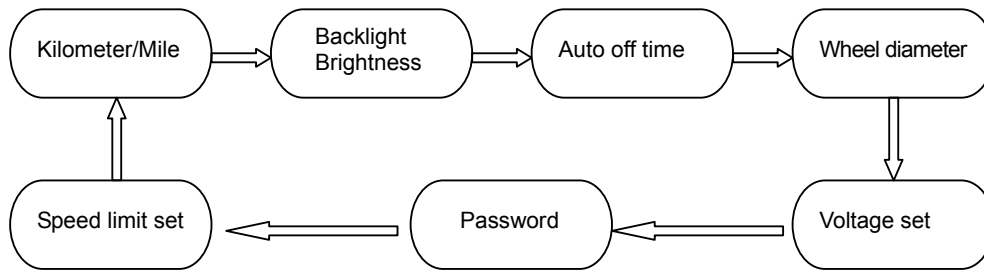

**8.1 Kilometer / Mile** : The location of speed displays symbol **S7**, press **UP/DOWN** button rotate display the symbol **km/h / MPH (Km / Mile)**

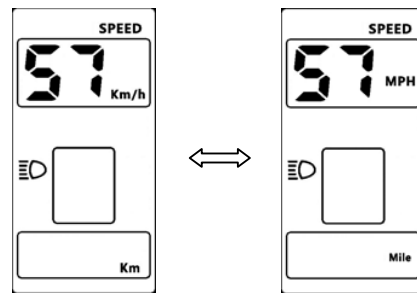

**8.2 Backlight brightness** : The location of speed displays symbol **bl1**, press **UP/DOWN** button display symbol **1~5** to change the brightness of the backlight.

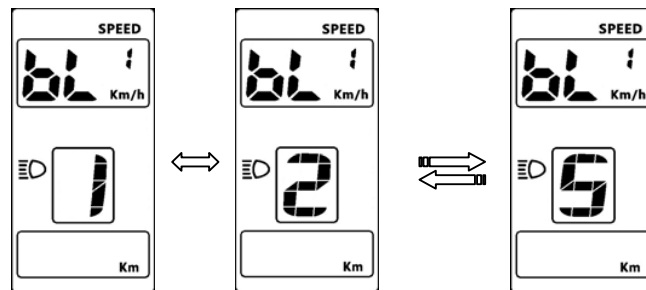

**8.3 Auto off time** : The location of speed displays symbol **OFF**, press **UP/DOWN** button to change the value from **1** to **9**, the number represent delay time (minutes) before display shutdown automatically, default value is 5 minutes.

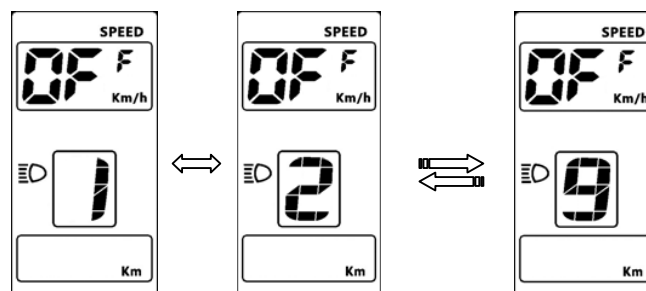

**8.4 Wheel diameter** : The location of speed displays symbol **Wd**, press **UP/DOWN** button rotate display the symbol **16/18/20/22/24/26/700C/28/29**, value represents the diameter of the wheel (inch). Wrong value for wheel diameter will cause speed&mileage abnormal.

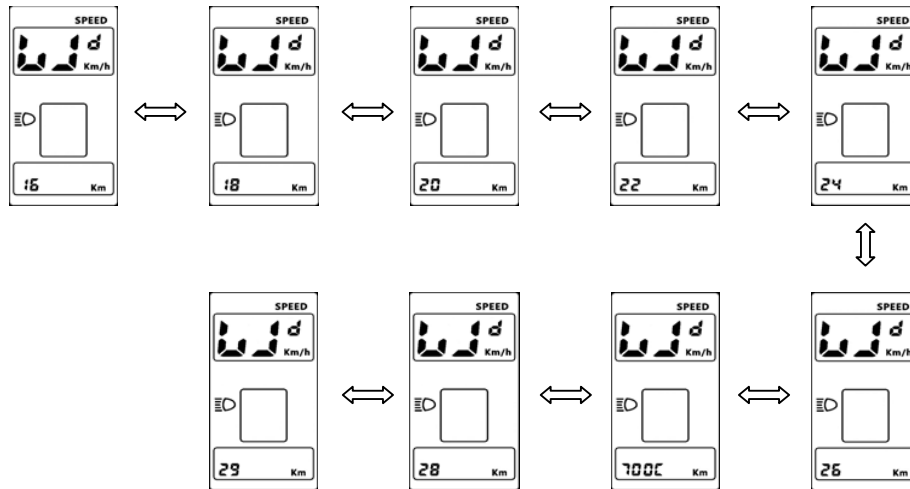

**8.5 Voltage set** : The location of speed displays symbol **bU0**, press **UP/DOWN** button rotate display the symbol **24V/36V/UbE**, **UbE** means user-defined voltage setting, this parameter can be set through computer.

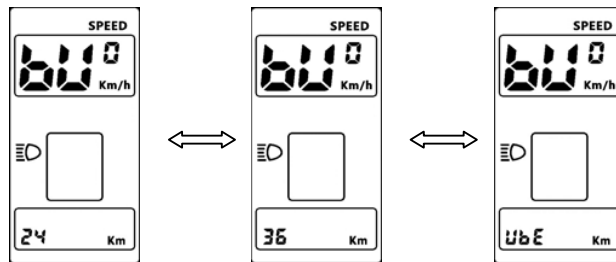

**8.6 Password/Speed limit set** : The location of speeds displays symbol **PSd**, require to input passwords, press **UP/DOWN** buttons to change the password value (0~9), short press **POWER** button to switch the password item, password is 4 digits, the default password is "1919". Press **POWER** button when password adjustment is completed. Display will return to the **Voltage set** item if the password is incorrect. Correct password will enter the **Speed limit set** item.

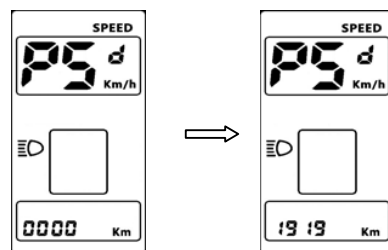

**8.7 Speed limit set** : The location of speed displays symbol **SPL**, the location of mileage displays speed limit value, the default value is **25km/h**. Press **UP/DOWN** buttons to modify the value, the value can be set from 10 to 45km/h. Press **POWER** button to confirm when you finish the adjustment.

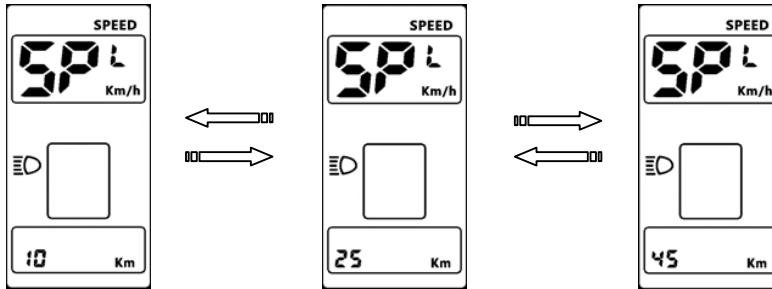

The maximum speed is restrict by the motor and controller, probably couldn't reach the setting value.

## 9 Error Code define

800S can give warning message when E-bike exist error, LCD display  icon and the error code in speed position, error code is from 01 E~07 E, the definition see the table below.

Error Code	Error description	Handle
01E	Communication Error	Check the cable connection
02E	Controller protection	Check three-phase power line.
03E	three-phase power error	Check three-phase power line connection
04E	Battery low	Charge the battery
05E	Brake error	Check the brake connection.
06E	Turn error	Check turn to connect.
07E	Hall error	Check the hall connection
08-99E	Reserved	Please contact the manufacturer for error definitions

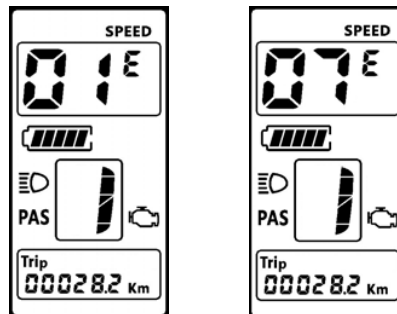



---

## 10 Assembly instructions

Please pay attention to the screw's torque value, damaged caused by excessive torque is not within the scope of the warranty.

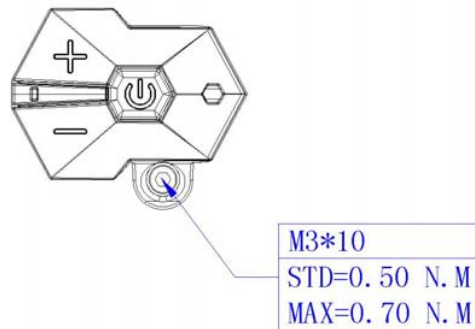
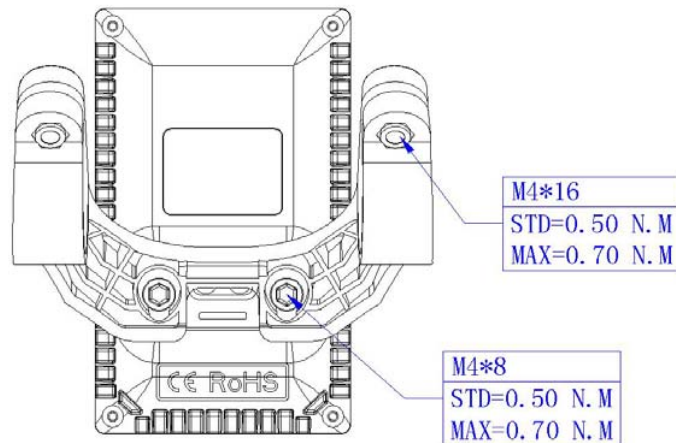

There are 2 directions for the clamp installation, forward or backward.

Different assembly methods will need different cable length.



---

Clamps suit for 3 size of handlebar, 31.8mm, 25.4mm, 22.2mm, there are transfer rings for 25.4mm and 22.2mm, transfer ring must be assembled with the special directions, pay attention to the green arrow below.

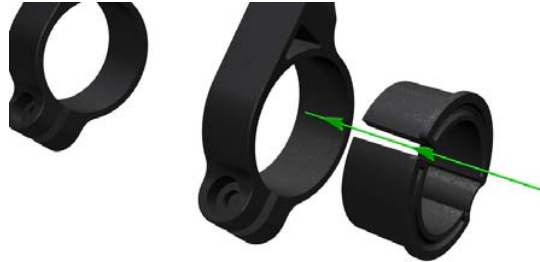

## 11 Warning

There is waterproof membrane inside the sound hole. Don't insert sharp object into the hole, it will causes waterproof failure.

Sun exposure may cause high temperature indicate, this is not display's failure.



## 12 Output wire instructions

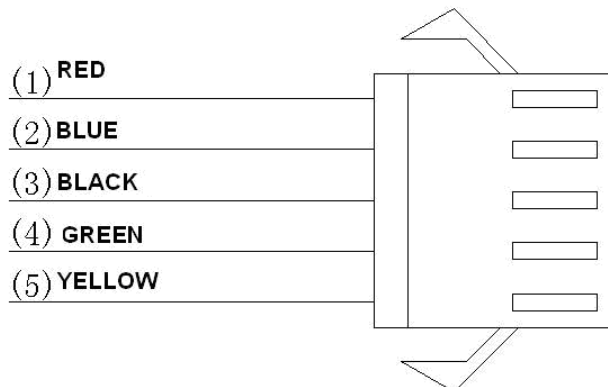

- 
- 1、 Red wire : Anode(24v/36v)
  - 2、 Blue wire : Power cord to the controller
  - 3、 Black wire : GND
  - 4、 Green wire : RxD (controller -> display)
  - 5、 Yellow wire : TxD (display -> controller)

## 13 Assist level instructions

Assist level can be customized, the highest level is 9, common used assist level see the table below:

3 level	5 level	9 level	
0		0	No power assist
	1	1	
		2	
1	2	3	
		4	
	3	5	
2		6	
	4	7	
		8	
3	5	9	

## 14 Certification

CE / IP65 (water proof) / ROHS.