

# Yale®

GRADE 1 LEVER CYLINDRICAL LOCKSETS

## 5400LN SERIES



# CATALOG



# RUGGED YET REFINED

Designed for industrial, commercial and institutional use, Yale's 5400LN Series heavy-duty cylindrical lockset offers no compromise when it comes to rugged reliability and performance. With key construction features, such as our patented Free Wheeling lever mechanism, wear-resistant chassis plates, heavy-duty lever return springs and through-bolting, this Grade 1 trendsetter proves time and again why it's the favorite among architects and building owners who demand the highest standard of product quality.

And who says a lockset can't be tough and look good at the same time? The 5400LN features three aesthetic lever designs and a diverse line of eleven architectural finishes, including three PVD lifetime finishes, which allow the freedom of enhancing any décor. With a lifetime warranty against lever sag and lever spring breakage, you'll never have to worry about your intended attraction becoming an unintended distraction.



## CONTENTS

Introduction . . . . .	2
Features . . . . .	3
Lever Designs . . . . .	4
Lockset Functions . . . . .	5-7
Cylinders . . . . .	8-9
Electrified . . . . .	10
Latchbolts . . . . .	11
Strikes . . . . .	12
Suggested Specification . . . .	13
Ordering Information . . . . .	14

### FREE WHEELING LEVER TRIM



All 5400LN locking functions feature the patented (Patent No. 4920773) Free Wheeling lever mechanism. When the outside lever is locked, it will rotate freely up and down while remaining securely locked.

### A.D.A.

The 5400LN meets accessibility guidelines of the Americans with Disabilities Act and the requirements of the Uniform Federal Accessibility Standards and ANSI 117.1, all requiring ease of accessibility for the handicapped.

### WARRANTY

The 5400LN Key-in-Lever cylindrical lock carries a comprehensive five-year warranty. Likewise, the lockset carries a lifetime warranty against lever sag and lever spring breakage. Ask your Yale sales representative for complete warranty information.

### INSTALLATION

Fits ANSI Spec. 115.2, which covers Hollow Metal Doors and Frame Preparation for Cylindrical Locksets, and doors with ANSI Spec A115.18 "Spider Cut Out."

### PVD LIFETIME FINISH

Physical Vapor Deposition (PVD) is a technologically advanced finish coating that provides the ultimate surface protection against environmental elements and everyday wear and tear. PVD matches clear coated finishes in appearance, yet surpasses them in durability. Yale warrants all its PVD finishes against corrosion, tarnish, wear, discoloring and peeling for the lifetime of the part to which it has been applied. Ask your sales representative for specific warranty information.

### ISO 9001

Designed and manufactured in a certified ISO 9001 facility.



### FINISHES

ANSI Code	Finish
605*	Bright Brass, PVD
606*	Satin Brass, PVD
609	Satin Brass, Blackened, Satin Relieved, Clear Coated
612	Satin Bronze, Clear Coated
613	Satin Bronze, Oxidized and Oil Rubbed
613e*	Satin Bronze, Oxidized and Oil Rubbed, PVD
616	Satin Bronze, Blackened, Satin Relieved, Clear Coated
619	Satin Nickel Plated, Clear Coated
625	Bright Chrome Plated
626	Satin Chrome Plated
693	Black Powder Coat

\*PVD finish standard on 605 and 606. Available as an option on 613 (as 613e) for customers desiring a non-wearing finish.

## FEATURES

### DOOR THICKNESS

The 5400LN fits doors from 1-3/4" to 2-1/4" thick. It can be used on 1-3/8" thick doors by adding two spacer plates P/N 14-5401-6644.

### FIRE LISTINGS

UL - cUL Fire Label for all door functions up to 3 hours.

### ANSI

ANSI A156.2, 1996 Series 4000 Grade 1.

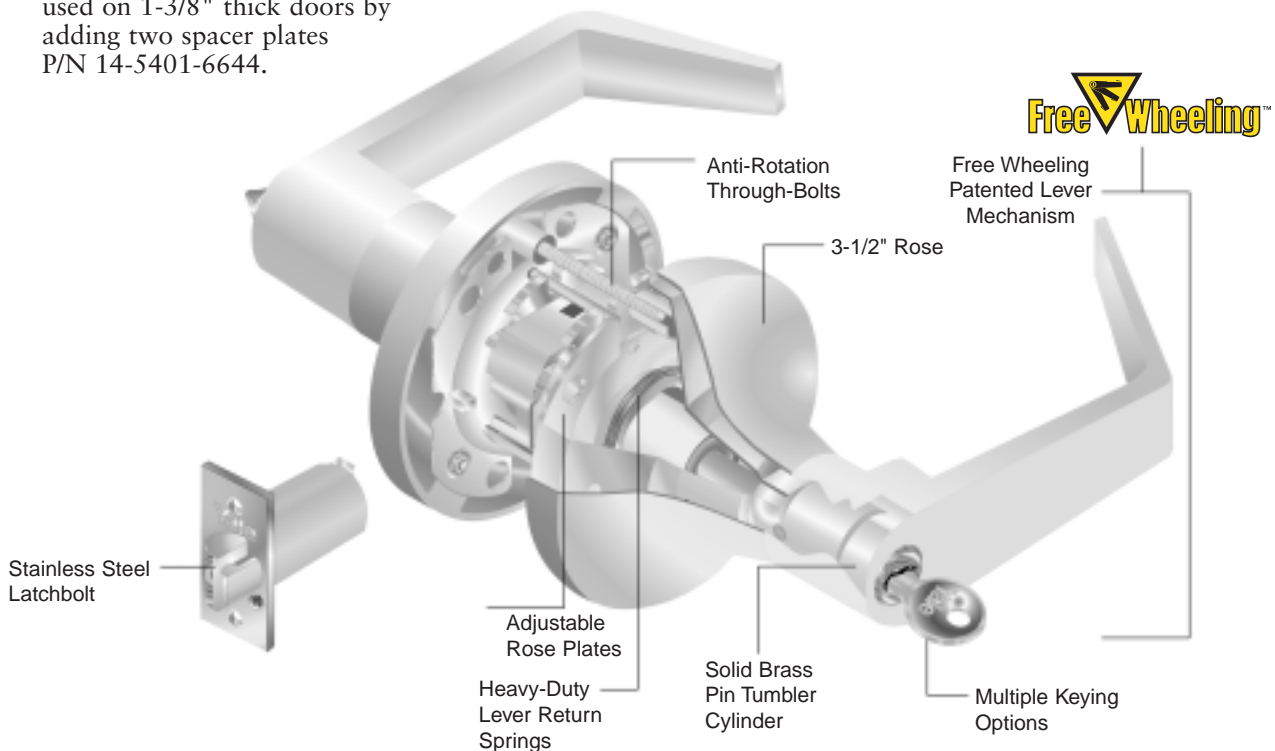

### FULL-FEATURED GRADE 1 LEVER LOCKSET OFFERING:

- Patented Free Wheeling lever mechanism increases vandal resistance and reduces the amount of maintenance typically required of locksets with rigid levers.
- 11 finish options.
- 3 lever designs
- 19 functions.
- Stainless steel latchbolt provides added strength and wear resistance. Direct 1/2" throw is standard.
- A 3/4" latch throw for fire-rated or pairs of doors is available.
- Wear-resistant plates in the chassis help extend the life of the lockbody and provide smoother lock operation.
- Longer through-bolts through the chassis provide greater stability and prevent rotation.
- Lifetime warranted heavy-duty lever return springs prevent lever sag and provide positive return of lever to horizontal position.
- Door adjustable rose support plates allow for easy adjustment of lockset to fit doors ranging in thickness from 1-3/4" to 2-1/4". Rose spacers available for 1-3/8" thick doors.
- Three non-handed lever options (Augusta, Monroe, and Pacific Beach) comply with ADA requirements for easy gripping and operation.
- Expanded cylinder and keying options:
  - Yale® 6- and 7-pin standard and interchangeable core cylinders including Yale® KeyMark® patented keyway cylinders (see page 8).
  - Standard cylinders with Schlage® C and Sargent® LA keyways.
  - Levers which accept interchangeable core cylinders by Best®, Corbin Russwin, Schlage® and Medeco® and ASSA®.
- 3-1/2" roses cover new ANSI hollow metal door cutout.

## LEVER DESIGNS

### AUGUSTA

Lever: Cast Solid  
Rose: Cold Forged Brass, Bronze

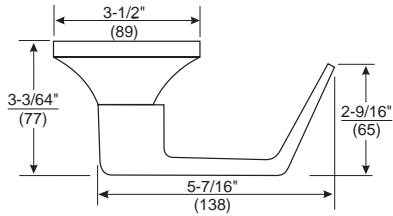

AU

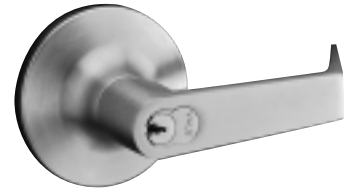

AU\*\*

### MONROE

Lever: Cast Solid  
Rose: Cold Forged Brass, Bronze

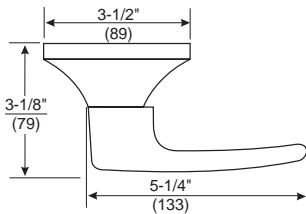

MO



MO\*\*

### PACIFIC BEACH

Lever: Cast Solid  
Rose: Cold Forged Brass, Bronze

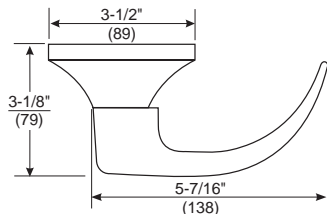

PB



PB\*\*

Dimensions are shown in inches (millimeters).

\*\* See page 8 and 9 for interchangeable core cylinder order options.

# LOCKSET FUNCTIONS

**5401LN (F75)**

**Passage or Closet Lock**

- For doors that do not require locking.
- Either lever operates latchbolt at all times.

Outside Inside

**5402LN (F76)**

**Privacy Bedroom or Bath Lock**

- For lavatory or other privacy doors.
- Either lever operates latchbolt unless outside lever is locked by pushbutton inside.\*
- Button automatically releases when inside lever is turned or door is closed.
- Emergency release in outside lever. Emergency key supplied. (PN 14-5302-1053-048)
- Inside lever always active.

Outside Inside

**5403LN (F77)**

**Patio or Privacy Lock**

- For exit doors with limited entry.
- Deadlocking latchbolt.
- Either lever operates latchbolt unless outside lever is locked by pushbutton inside.\*
- Button automatically releases when inside lever is turned or door is closed.
- Inside lever always active.

Outside Inside

**5404LN (F82)**

**Entry Lock**

- For entrance or office doors.
- Deadlocking latchbolt.
- Either lever operates latchbolt (except when outside lever is locked from inside).\*
- Pushing button in inside lever locks outside lever. (Automatically releases when inside lever is turned or key is rotated in locked outside lever.)
- Latchbolt is operated by key in outside lever or by rotating inside lever.
- Inside lever always active.

Outside Inside

**5405LN (F86)**

**Storeroom or Closet Lock**

- For use on storeroom, utility, and exit doors.
- Deadlocking latchbolt.
- Latchbolt operated by lever inside, key in outside lever.
- Outside lever always locked.\*
- Inside lever always active.

Outside Inside

**5406LN (F92)**

**Service Station Lock**

- Deadlocking latchbolt.
- Either lever operates latchbolt.
- Pushbutton in inside lever locks outside lever. (Automatically releases when inside lever is turned, door is closed or key is rotated in outside lever, except when slotted pushbutton is rotated 90° clockwise to retain outside lever in locked position.)\*
- Latchbolt operated by key in outside lever, inside lever always active.

Outside Inside

\* Lever handles are Free-Wheeling in locked position. Shaded area denotes Free-Wheeling lever.

# LOCKSET FUNCTIONS

**5407LN (F109)**

**Entrance or Corridor Lock**

- For entrance, general home or office doors.
- Deadlocking latchbolt.
- Either lever operates latchbolt (except when outside lever is locked from inside).\*
- Pushing turn button in inside lever locks outside lever, and automatically releases when inside lever is turned or key is rotated in locked outside lever.
- Outside lever may be retained in locked position by pushing and rotating turn button 90° clockwise to a horizontal position; not released until turn button is manually returned to the vertical position.
- Latchbolt is operated by key in outside lever or by rotating inside lever.
- Inside lever always active.

Outside Inside

**5408LN (F84)**

**Classroom Lock**

- For classroom or utility room doors.
- Deadlocking latchbolt.
- Either lever operates latchbolt (except when outside lever is locked by key).\*
- Inside lever always active.
- Outside lever locked\* or unlocked only by key.

Outside Inside

**5409LN (F89)**

**Exit Lock**

- For exit doors with no-entry desired.
- Deadlocking latchbolt.
- Outside lever always locked.\*
- Inside lever always active.

Outside Inside

**5418LN**

**Classroom Intruder Lock**

- For classroom doors.
- Deadlocking latchbolt.
- Either lever operates latchbolt (except when outside lever is locked by key in either lever).
- Outside lever remains locked upon egress.
- Inside lever always active.

Outside Inside

**5417N (F88)**

**Apartment, Exit or Public Toilet Lock**

- For office or apartment building entrance doors or lavatory doors.
- Deadlocking latchbolt.
- Either lever operates latchbolt (except when outside lever is locked by key from inside).\*
- Key in outside lever operates latchbolt.
- Inside lever always active.

**NOTE: Inside handle requires 1802S standard 6-pin cylinder.**

Outside Inside

**5418LN (F110)**

**Intruder Classroom Security Lock**

- For classroom doors.
- Deadlocking latchbolt.
- Either lever operates latchbolt (except when outside lever is locked by key from either side).
- Key either inside or outside locks or unlocks outside lever.
- Inside lever always active.

Outside Inside

\* Lever handles are Free-Wheeling in locked position. Shaded area denotes Free-Wheeling lever.

# LOCKSET FUNCTIONS

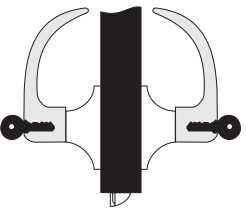
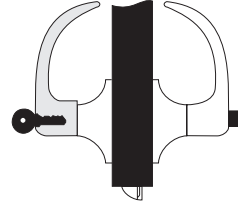
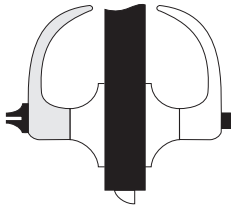
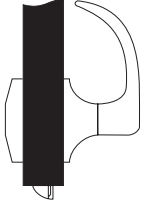
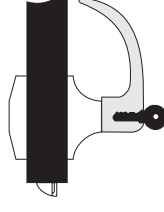
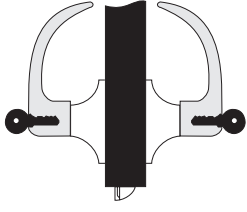
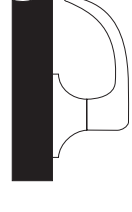
<p><b>5421LN (F80)</b></p> <p><b>Communicating Lock</b></p> <ul style="list-style-type: none"> <li>For communicating or store entrance doors.</li> <li>Deadlocking latchbolt.</li> <li>Either lever operates latchbolt (except when key in either lever locks or unlocks the lever independently of the other).*</li> <li>Should be used only in offices or rooms with multiple entries.</li> </ul> <p><b>NOTE: Not available with IC core cylinders.</b></p>  <p>Outside      Inside</p>	<p><b>5422LN (F90)</b></p> <p><b>Dormitory Lock</b></p> <ul style="list-style-type: none"> <li>Deadlocking latchbolt.</li> <li>Either lever operates latchbolt (except when outside lever is locked by inside pushbutton or key in outside lever).* Inside lever always active.</li> <li>When locked by button, the button automatically releases when inside lever is turned or door is closed.</li> <li>When locked by key, the automatic release is made inoperative and must be manually unlocked by the key.*</li> </ul>  <p>Outside      Inside</p>	<p><b>5425LN</b></p> <p><b>Privacy Lock</b></p> <ul style="list-style-type: none"> <li>For lavatory or other privacy doors.</li> <li>Either lever operates latchbolt (except when outside lever is locked by inside pushbutton).*</li> <li>Button automatically releases by turning inside lever or closing door.</li> <li>Door can be unlocked, when necessary, by operating outside turnbutton.</li> <li>No emergency key required.</li> </ul>  <p>Outside      Inside</p>	
<p><b>5428LN</b></p> <p><b>Exit Latch</b></p> <ul style="list-style-type: none"> <li>For twin communicating or exit doors where one side operation is required.</li> <li>Use where space is limited.</li> <li>Deadlocking latchbolt.</li> <li>One lever operation.</li> <li>Blank rose.</li> <li>Should be used only where rooms have more than one entrance.</li> </ul>  <p>Outside      Inside</p>	<p><b>5429LN</b></p> <p><b>Communicating or Closet Lock</b></p> <ul style="list-style-type: none"> <li>For twin communicating or closet doors where one side operation or space between doors is limited.</li> <li>Deadlocking latchbolt.</li> <li>Inside lever operates latchbolt except when lever is locked by key.*</li> </ul> <p><b>(Not available with IC core cylinders.)</b></p>  <p>Outside      Inside</p>	<p><b>5430LN (F87)</b></p> <p><b>Utility, Asylum or Institutional Lock</b></p> <ul style="list-style-type: none"> <li>Deadlocking latchbolt.</li> <li>Latchbolt operated by key in lever from either side.</li> <li>Both levers always locked.*</li> </ul> <p><b>(Not available with IC core cylinders.)</b></p>  <p>Outside      Inside</p>	<p><b>455LN</b></p> <p><b>Dummy Trim</b></p> <ul style="list-style-type: none"> <li>For non-operational lever use for decorative trim.</li> </ul>  <p>Outside      Inside</p>

\* Lever handles are Free-Wheeling in locked position. Shaded area denotes Free-Wheeling lever.

# CYLINDERS

## CYLINDER OPTIONS

The following selection guide indicates the correct key-in-lever cylinder for each locking segment.

Lockset Series: 5400LN		Types of Cylinder Mechanisms								
		Conventional		Patented Keyway		Security		High Security		
Cylinder Types	Fixed Core	6-pin	7-pin	6-pin	7-pin	6-pin	7-pin	6-pin	7-pin	
	Key-In-Knob	1802	1802A	K402	K402	5802	5802A	N/A	N/A	
	Interchangeable Core									
	LFIC	1210	N/A	K800	N/A	5210	5220	N/A	N/A	
SFIC	N/A	N/A	K600	N/A	N/A	N/A	N/A	N/A		

Refer to Yale® KeyMark® and/or Cylinders and Keys Catalog sections for all details and how to order examples.

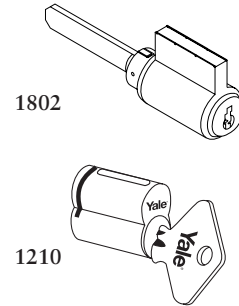

## Yale® KeyMark® PATENTED KEYWAY CYLINDERS

For those applications requiring patented key control, Yale's KeyMark® line of patented keyway cylinders provides the ultimate protection against unauthorized key duplication. *Yale* KeyMark's utility-patented Security Leg® keyway features increased resistance against picking and impressioning and can easily retrofit into existing systems. For further details and availability, refer to the separate *Yale KeyMark* catalog.

## SECURITY CYLINDERS

The patented Yale® Security Cylinder (Patent No. 4638651) contains two independent locking mechanisms. The first is a traditional 6- or 7-pin tumbler mechanism with spool drivers for greatly increased picking resistance.

The second is an innovative 5-tumbler rotating disc mechanism with sidebar engagement. The rotating discs are spring loaded and block the bottom of the keyway.

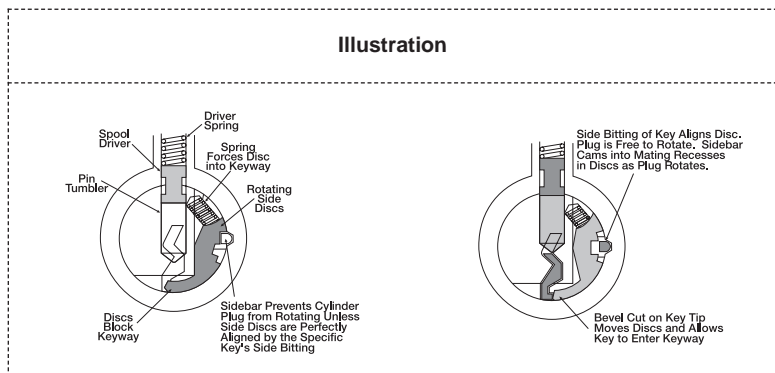



# CYLINDERS

## LEVERS ACCEPTING COMPETITORS' INTERCHANGEABLE CORE CYLINDERS

	Interchangeable Core System	Prefix	Ordering Example
	Best®	B (i.e. B-AU, B-PB, B-MO)	B-AU5407LN x 626
	Schlage®	SI (i.e. SI-AU, SI-PB)*	SI-AU5407LN x 626
	Corbin Russwin	R (i.e. R-AU, R-PB)*	R-AU5407LN x 626
	Medeco®, ASSA®	M (i.e. M-AU)**	M-AU5407LN x 626

\*Schlage® and Corbin Russwin options not available with MO levers.  
 \*\*Medeco®, ASSA® option available only with AU lever.

## 107S SCHLAGE® CYLINDER ADAPTER KIT

Used to modify *Schlage* cylinder for fit in the 5400LN.  
 P/N 14-5407-0300-048

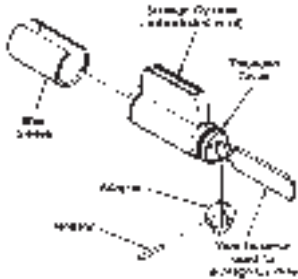

## SCHLAGE® C & SARGENT® LA KEYWAY

Illustration	List Number	Number of Pins
	2802	Schlage® 6-pin C Keyway O-Bitted or Keyed Random
	3802	Sargent® 6-pin LA Keyway O-Bitted or Keyed Random

# ELECTRIFIED

## ELECTRIFIED 5400LN CYLINDRICAL LOCKSET



- Features**
- Patented Free Wheeling lever mechanism.
  - Self-contained, continuous-duty integral solenoid (allows installation in standard cylindrical prep).
  - Available Fail Safe or Fail Secure.
  - Available in 12 or 24 volts AC/DC.
  - External rectifier for AC operation.
  - Mechanical cylinder override.
  - All 5400LN cylinder options.
  - ANSI Grade 1.
  - UL listed.

### OPERATION

Electric locks provide the ability to electrically lock or unlock the outside trim from a remote location. Fail Safe locks are commonly used in stair towers to release upon fire alarm activation. Fail Secure locks are used on perimeter doors or security doors to allow ingress using access control technologies (proximity cards, keypads, etc.)

Outside	Inside	Function	Function Description
		5490LN	<p><b>Fail Safe</b></p> <ul style="list-style-type: none"> <li>• Power on/locks outside lever.</li> <li>• Inside lever always free.</li> <li>• Latchbolt retracted by key when locked electrically.</li> <li>• Free Wheeling lever when locked electrically.</li> </ul>
		5491LN	<p><b>Fail Secure</b></p> <ul style="list-style-type: none"> <li>• Power on/unlocks outside lever.</li> <li>• Inside lever always free.</li> <li>• Latchbolt retracted by key when power is off.</li> <li>• Free Wheeling lever when power is off (locked).</li> </ul>

## LATCHBOLTS

### PLAIN LATCHBOLTS

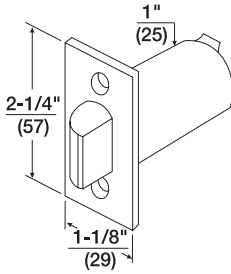

List No.	Front	Backset	Throw	Front Width	Latch Diameter
F693	Flat	2-3/4"	1/2"	1-1/8" (29mm)	1" (25mm)
693	Beveled	2-3/4"	1/2"	1-1/8" (29mm)	1" (25mm)
3693	Beveled	3-3/4"	1/2"	1-1/8" (29mm)	1" (25mm)

Note: For 3/4" throw applications, only deadlocking latchbolts available.

### DEADLOCKING LATCHBOLTS

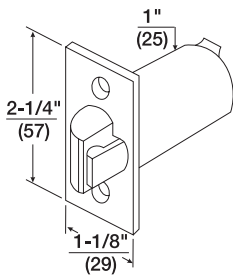

List No.	Front	Backset	Throw	Front Width	Latch Diameter
F694	Flat	2-3/4"	1/2"	1-1/8" (29mm)	1" (25mm)
F480B	Flat	2-3/4"	3/4"	1-1/8" (29mm)	1" (25mm)
694	Beveled	2-3/4"	1/2"	1-1/8" (29mm)	1" (25mm)
480B	Beveled	2-3/4"	3/4"	1-1/8" (29mm)	1" (25mm)
3694	Beveled	3-3/4"	1/2"	1-1/8" (29mm)	1" (25mm)
3480B	Beveled	3-3/4"	3/4"	1-1/8" (29mm)	1" (25mm)

## STRIKES

### STRIKES

Yale® 5400LN locksets are supplied standard with a 497 ANSI strike.

A variety of optional strikes are also available. All strikes are located on the same vertical and horizontal center lines as the latchbolt. Some strikes are available in a variety of lip lengths to accommodate varying thickness of doors and frames. To determine the proper length of the lip, measure from the center line of the strike to the edge of the jamb and add 1/4" (6mm). All strikes are reversible.

<p><b>List No. 497 ANSI Strike</b> 1-1/4" supplied standard with 5400LN. 1-1/8", 1-1/2", and 1-3/4" lip lengths available by special order. For door and frames with ANSI A115.2 preparations.</p>	<p><b>List No. 495 Strike</b> 1-1/4" curved lip, wrought box supplied. 1", 1-1/2", 1-3/4" and 2" curved lip lengths available by special order.</p>	<p><b>List No. 497B Blank ANSI Strike</b> Available to special order. Installed in frame with standard ANSI A115.2 preparation to replace the strike when the lockset has been removed from the door.</p>	<p><b>List No. 202 Strike Box</b> Available to special order. Specify 497 x 202.</p>

### ATTACHING SCREWS

**For List No. 495**  
#8-8-32 x 3/4" (19mm) Phillips flat head combination wood and machine screws.  
P/N 81-2012-0416

**For List Nos. 497 and 497B**  
#12-12-24 x 1" Phillips flat head combination wood and machine screws.  
P/N 81-2012-0620

**NOTE:** When ordering strike or attaching screws individually, specify the finish required; i.e. 497 x 202 x 606.

## SUGGESTED SPECIFICATION

### GRADE 1 LEVER CYLINDRICAL LOCKSET

Lockset chassis shall be constructed of heavy-gauge cold-rolled steel, zinc dichromate plated to protect against rust and corrosion. Locksets shall be adjustable to fit doors between 1-3/4" (44mm) to 2-1/4" (57mm) thick.

Locksets shall be non-handed, and shall install easily without the need for specialized installation tools. Locksets shall have separate anti-rotation throughbolts in the 6 o'clock and 12 o'clock position outside the 2-1/8" face bore, and shall have no exposed mounting screws.

Locksets shall have solid one-piece, cast levers without plastic inserts, and shall be a minimum of 5-1/4" in length. Levers shall operate independently, and shall have inside and outside lever return springs. Outside levers on the keyed locksets shall be removable only when the designated key is in the cylinder.

Locksets shall have the capability of accepting 7-pin standard, interchangeable core and high security cylinders to provide expansion capacity for large master keyed systems.

Vandal resistant levers shall be offered as a standard feature in all locking functions, and shall be Free Wheeling in the locked condition. Locksets that are rigid in the locked condition, or which must require resetting (breakaway) are not acceptable.

The latchbolt shall be made of stainless steel.

All locksets shall carry a comprehensive five-year mechanical warranty. Locksets shall carry a lifetime warranty against lever sag or lever spring breakage.

All locksets shall comply with the following certifications:

- UL 3 Hour Fire Rating
- ANSI A156.2 Series 4000, Grade 1
- ANSI A117.1 Accessibility Code
- ANSI A115.18 Preparation

All locksets shall be 5400LN Series Grade 1 Key-in-Lever cylindrical locksets as assembled by Yale Commercial Locks and Hardware.



# ORDERING INFORMATION

From this outline select the List Number for the Yale® 5400LN Series Cylindrical Lockset you require.

Design	Function	Latch	Strike	Cylinder	Door Thickness	Finish
See Page 4	See Pages 5-7	See Page 11	See Page 12	See Pages 8-9	See Page 3	See Page 2

## ORDERING EXAMPLE

Quantity	Design	Function	Latch	Strike	Cylinder	Door Thickness	Finish
100	AU	5407LN	F694	497	1802	1-3/4"	626

## PACKING

Each box has a strike, paper template, combination wood and machine screws, lever release tool and easy-to-follow instructions. Cylinder functions supplied with two keys. Ten shelf boxes to a case.



**MY CHILD GOES TO A SCHOOL  
THAT'S REALLY TOUGH TO GET INTO.**

**CLASSROOM INTRUDER CYLINDRICAL LOCKSET**



PART # **5418LN**

It doesn't matter how high your test scores are, or who you know. Getting into a classroom secured by a Yale Classroom Intruder won't be easy. Not without a key anyway. Yale, the most respected name in locks, introduces total classroom control with the Classroom Intruder. Its double-cylinder design locks from either side with a key. Exit is possible at any time. And even after exiting, the door still remains locked to the outside.

[WWW.YALELOCKS.COM](http://WWW.YALELOCKS.COM)

DISTRIBUTION:  
**888-828-8349**

Yale® is a registered trademark of Yale Security Inc.

**Yale®**

# online literature and templates

For the latest information on Yale Commercial Lock and Hardware products, visit our website at [www.yalelocks.com](http://www.yalelocks.com).

*Click on the "Literature" button to find:*

- Catalogs
- Parts manuals
- Templates
- Specifications
- Installation instructions

*Yale® customers can click on the ebusiness symbol  on the website to register for an ebusiness account to:*

- Check the status of orders
  - Check availability of Warehouse and Quick-Ship items
  - Track your order and confirm delivery
  - Receive email notification of template changes
- And More...

[www.yalelocks.com](http://www.yalelocks.com)



#### **Yale Commercial Locks and Hardware**

Address: 1902 Airport Road, Monroe, NC 28110 USA

Tel: 1-800-438-1951 • Fax: 1-800-338-0965 • [www.yalelocks.com](http://www.yalelocks.com)

#### **Yale-Corbin Canada Ltd.**

Address: 6940 Edwards Boulevard, Mississauga, Ontario, Canada L5T 2W2

Tel: 1-800-461-3007 • Fax: 1-800-461-8989 • [www.yalecorbin.on.ca](http://www.yalecorbin.on.ca)

Yale® and Yale Security Inc.® are registered trademarks of Yale Security Inc. Other product brand names may be trademarks or registered trademarks of their respective owners and are mentioned for reference purposes only. Copyright© 2001, 2003 Yale Security Inc. All rights reserved. These materials are protected under US copyright laws. All contents current at time of publication. Yale Security Inc. reserves the right to change availability of any item in this bulletin, its design, construction, and/or its materials.

The ASSA ABLOY Group is the world's leading manufacturer and supplier of locking solutions, dedicated to satisfying end-user needs for security, safety and convenience.