













User Manual for 4122B/4122C Foot SPA Chair



Packing list

No.	Part	Picture	QTY	No.	Part	Picture	QTY
01	Shower Head		1	09	Allen Key		1
02	Seal Ring		2	10	Hand Controller		1
03	Seal Ring		2	11	5 X20 Tapping Screw		3
04	Drainage Pipe		1	12	Power Cord		1
05	M10X35 Inner Hexagon Screw		4				
06	Gasket		4				
07	Spring Gasket		4				
08	Rubber Gasket		1				

1. Installation Steps

- 1) Open the packing carton, connect and tighten the water pipe with shower head. (See as illustration 1)
- 2) Assemble switch A as the installation diagram below. Put the metal cover on the square plastic strip. And then screw the inner hexagon screw on square plastic strip through the cover hole. Finally stopple the cover hole with red stopple.

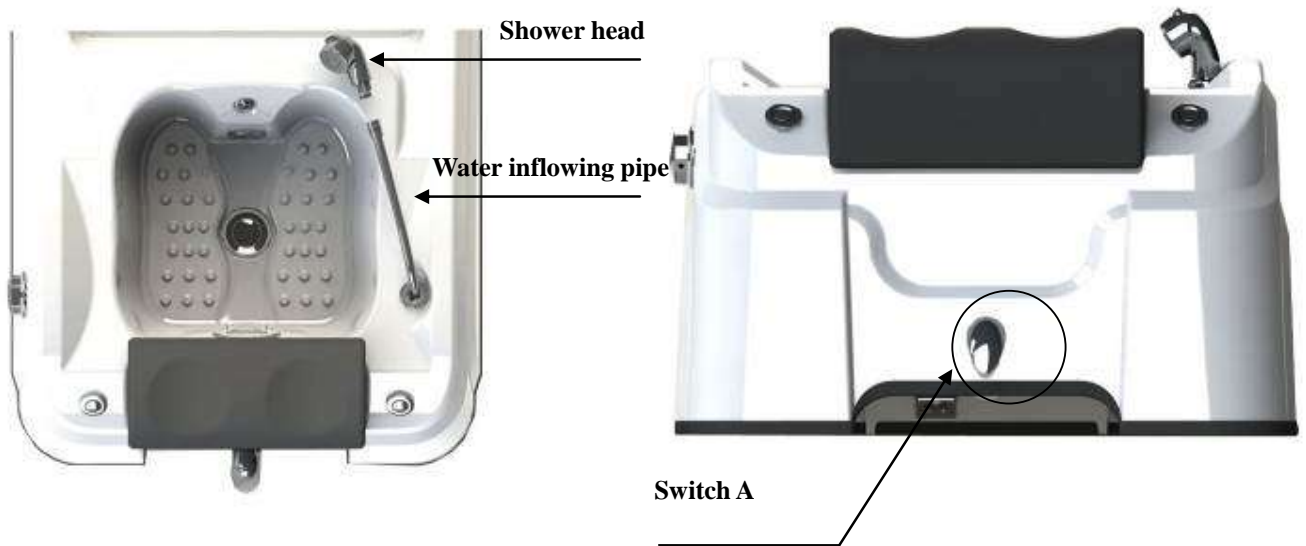
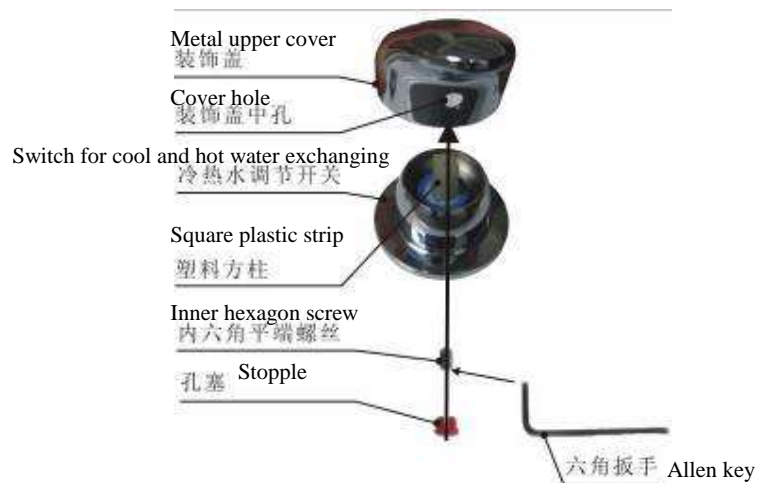

Illustration 1



Installation Diagram of Switch A

- 3) Assemble the drainage pipe and inflow pipe as following. (Left is for cool water, right is for hot water)
- a) See illustration 2 for the standard configuration.

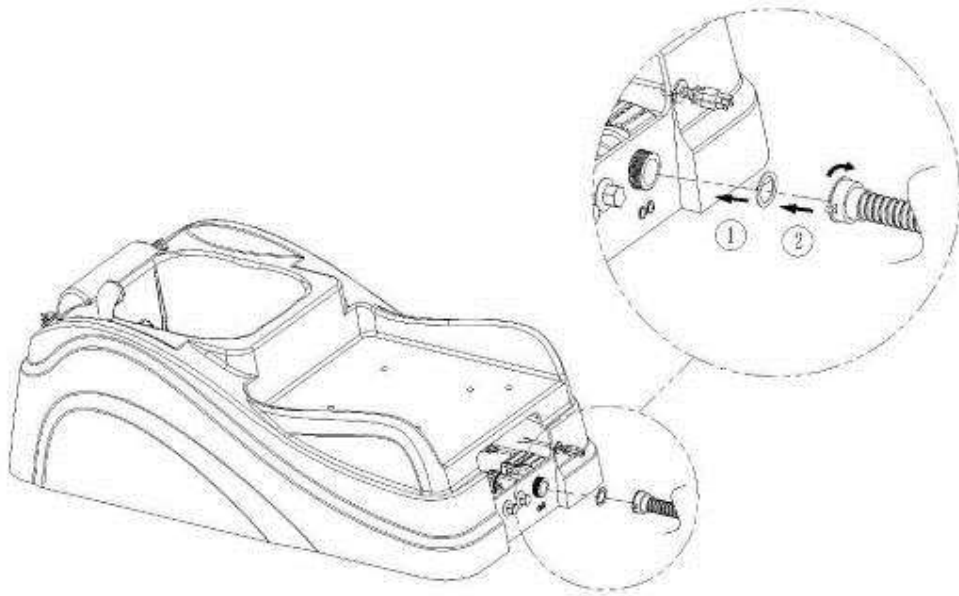

Illustration 2

- b) Put the end of drainage pipe into the floor drain outlet. (See as illustration 3)
- c) Plug the power supply on. Now the foot SPA is ready. (See as illustration 3)

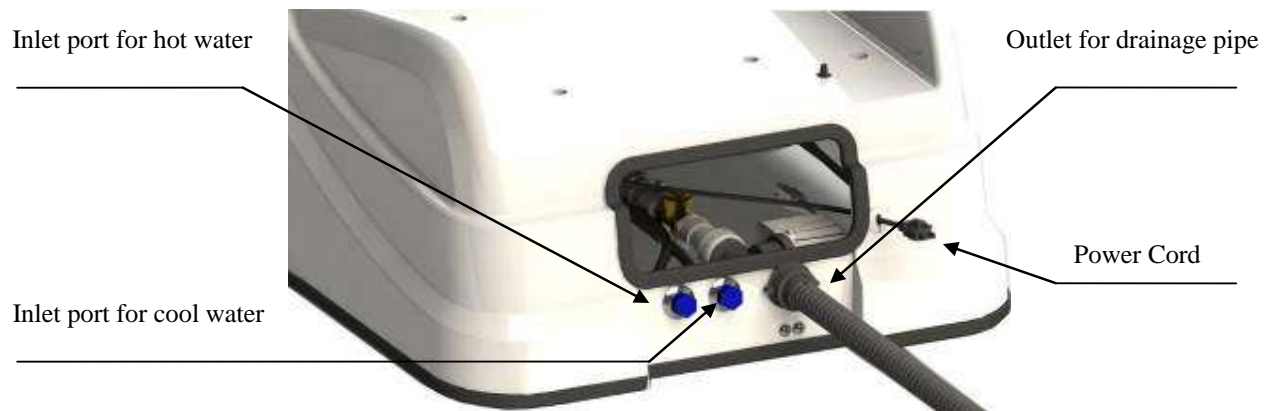

Illustration 3

4) Put the base of massage chair on the foot SPA. Use Allen key to screw the 4PCS* M10 inner hexagon screws together with the gaskets.

STEP 1 Put the base of massage chair on the foot SPA.



STEP 2 There's a hole at the backside of base. You can screw the screws, gaskets and spring gaskets to fasten the chair on the base through it.

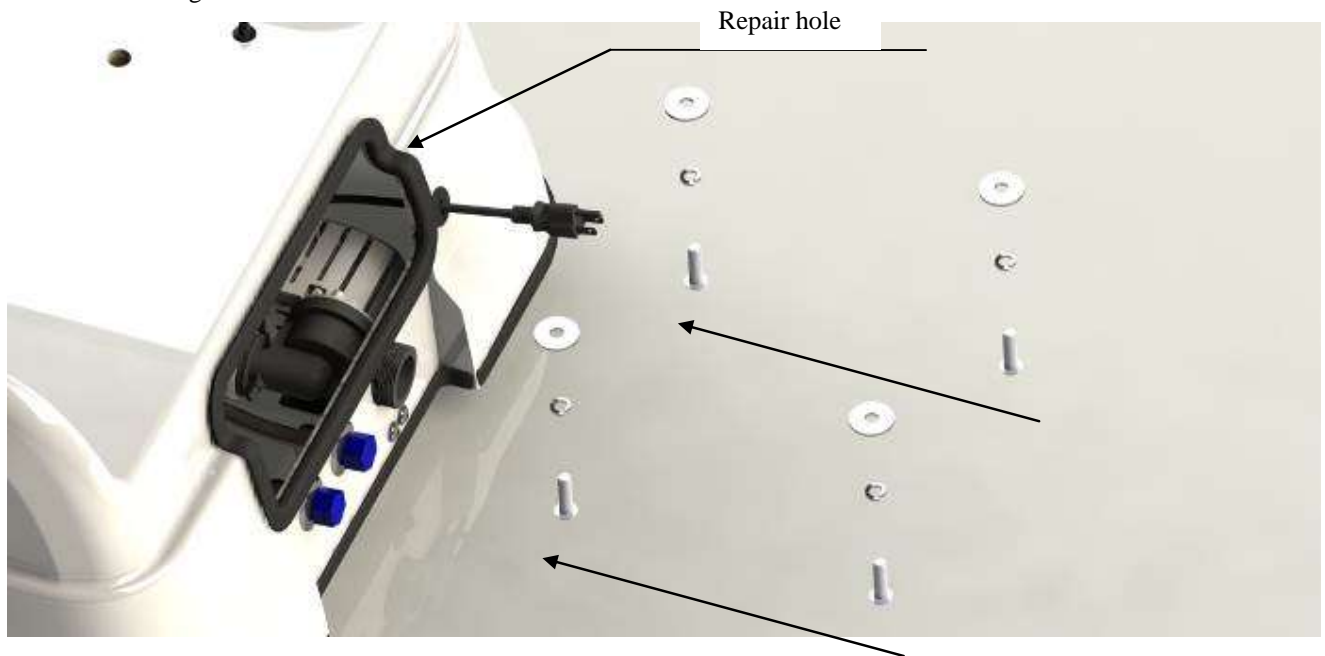

STEP 3

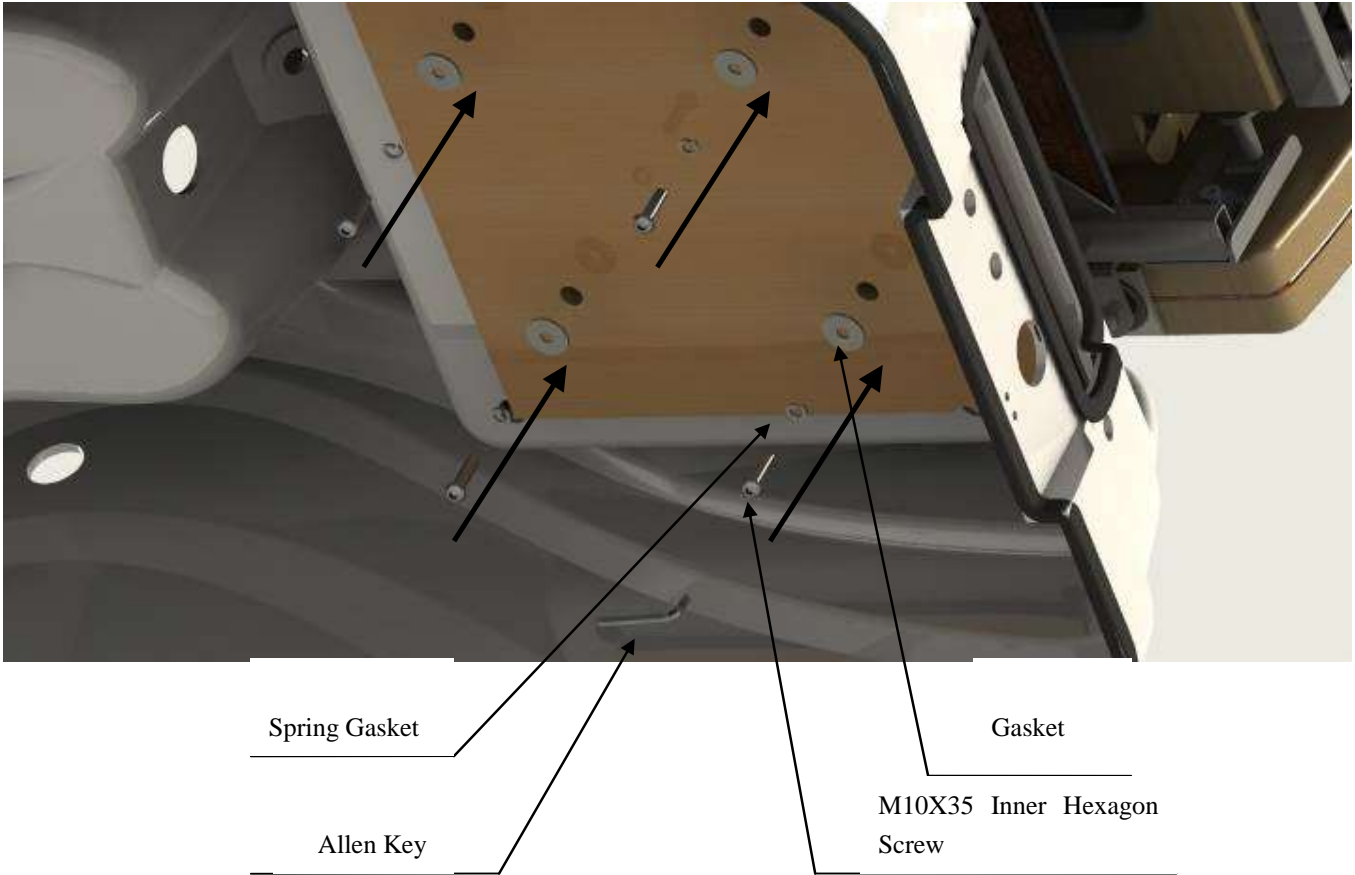

6) Assemble the backrest of foot SPA chair as illustrations below.

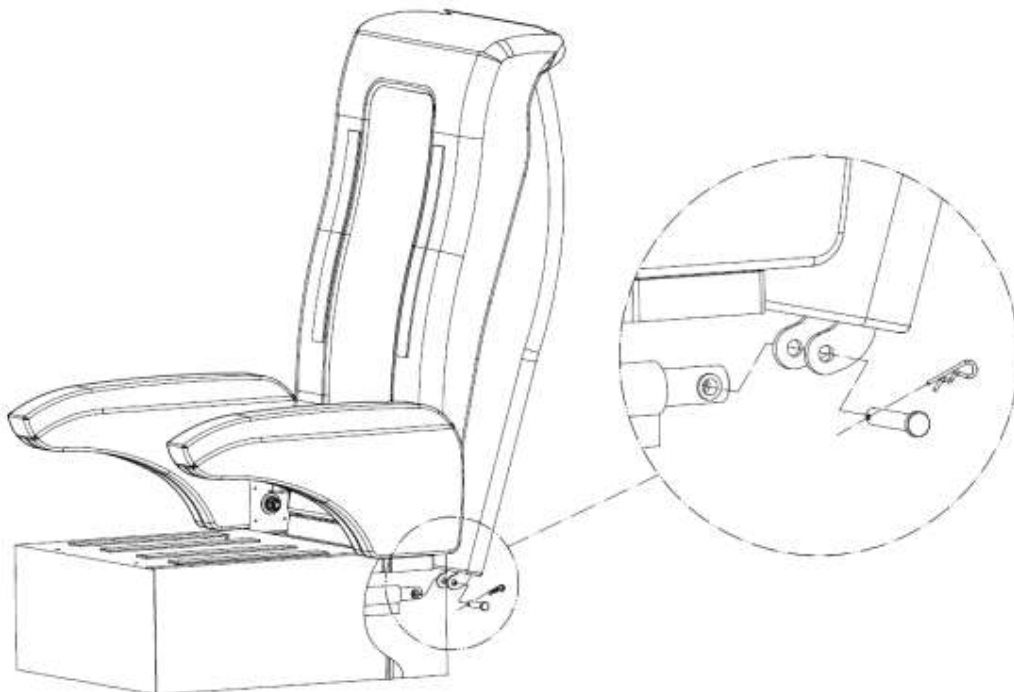

7) Assemble the upholstery for the backrest as illustration below.

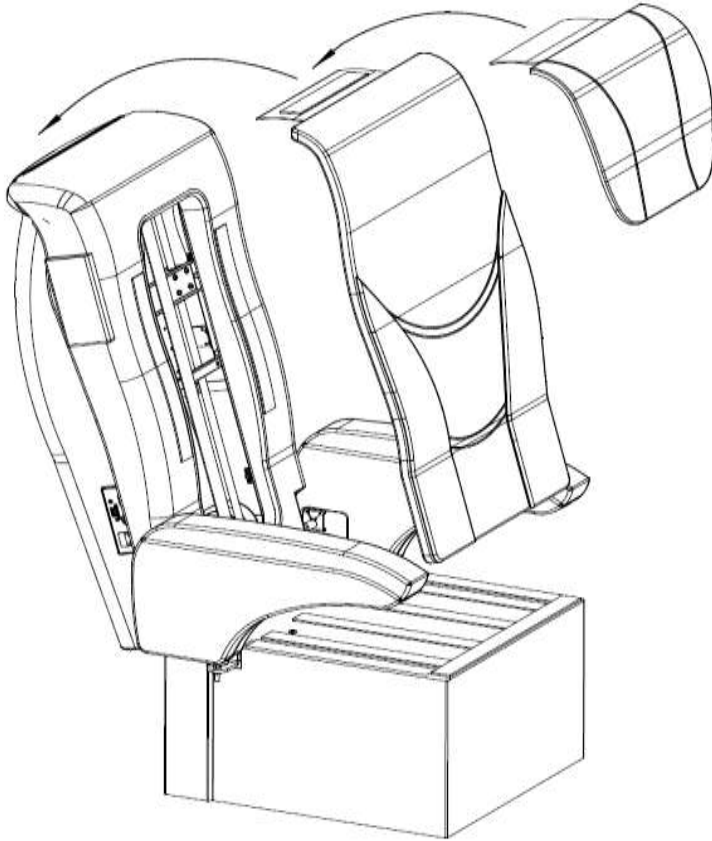

8) Put the cushion on the seat, while connecting the air pipe. Plug the motors on the control box corresponding to the number marked.

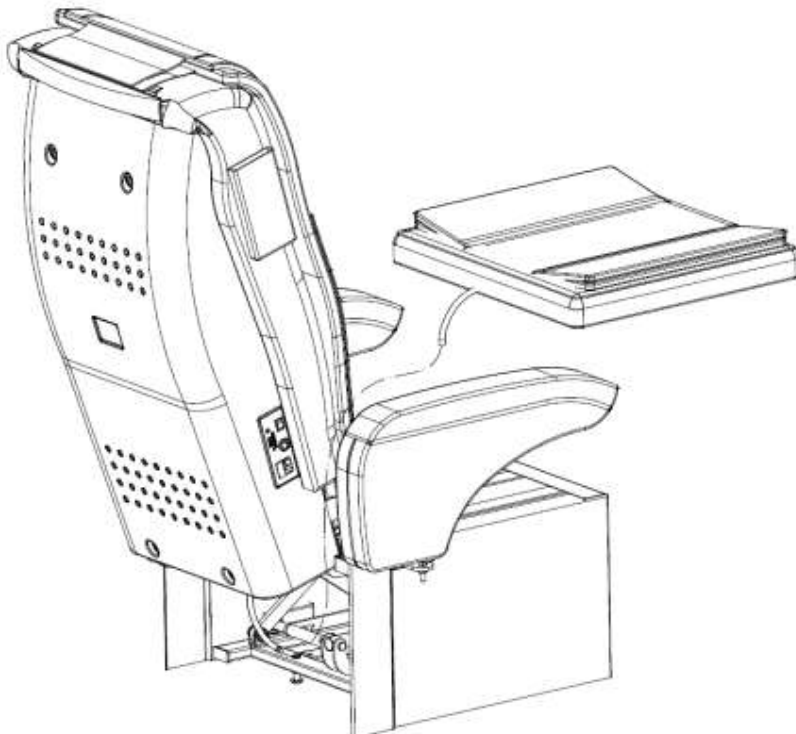

9) Screw the hand controller on the right armrest.

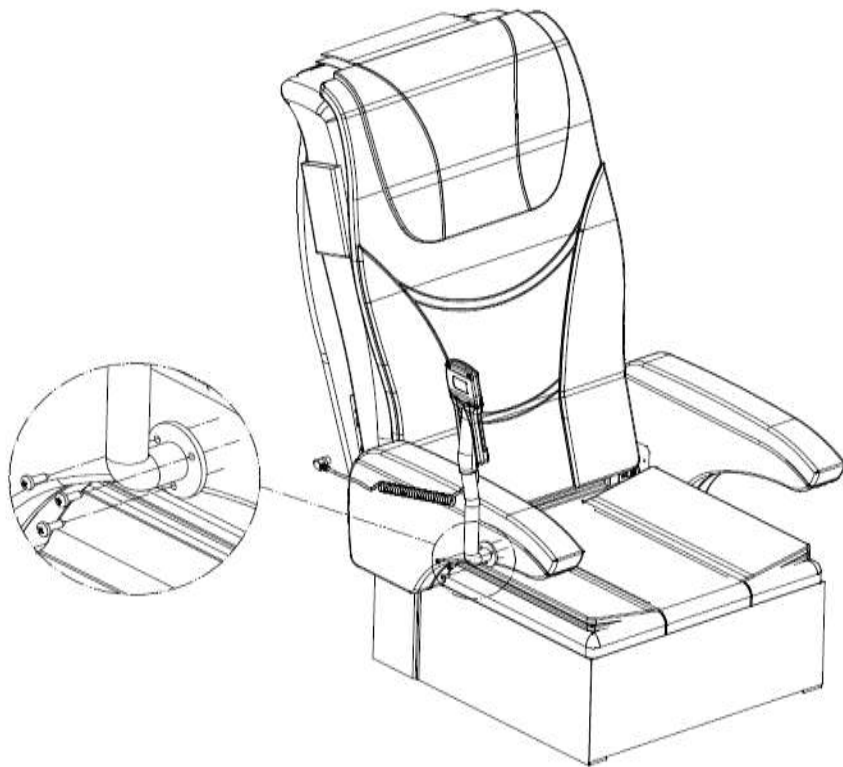

2. Operation Instruction

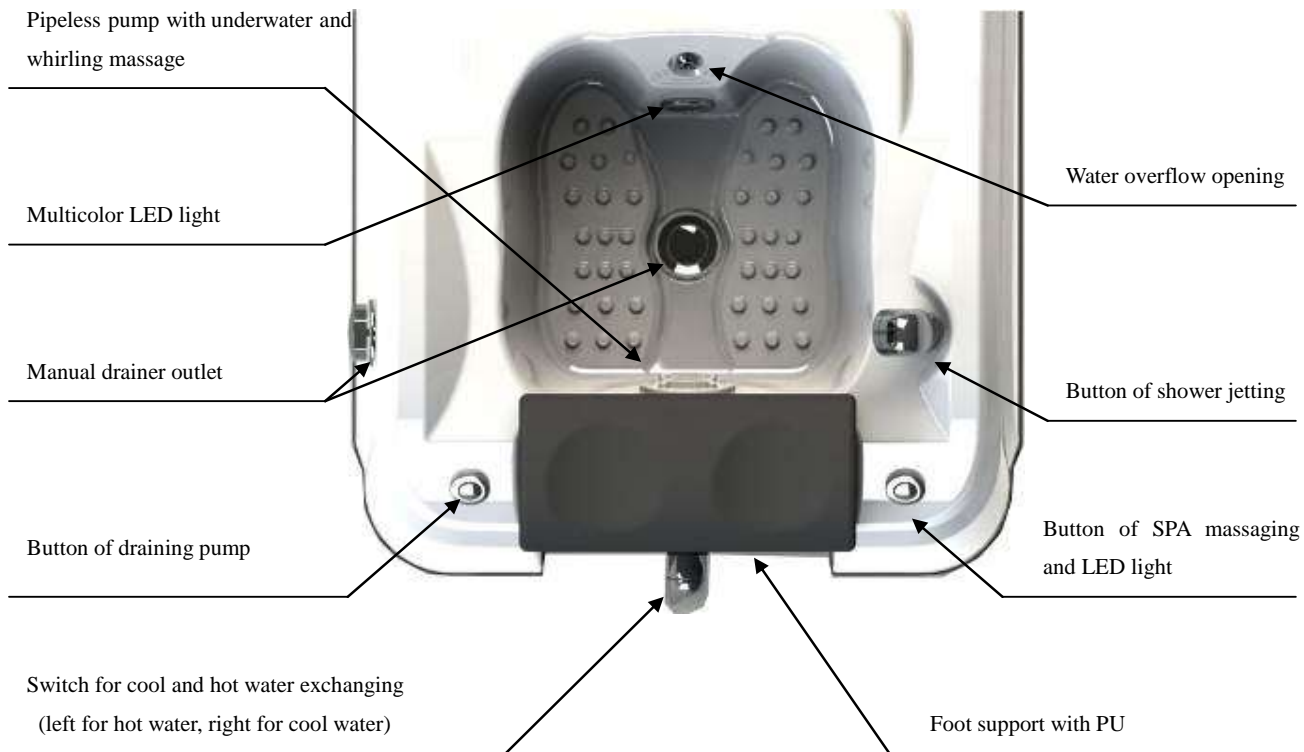

1. Draining function: turn the knob of manual drainer firstly when you want to drain water. And then press the button of drain pump which has the function of timekeeping.
2. Switch for cool and hot water exchanging---- adjust the water temperature by rotating it in clockwise or anticlockwise direction.
3. Button of SPA massaging and LED light--- Underwater and whirling massage works and LED lights up after pressing it. Repeating can stop massaging and lighting.
4. Button of shower jetting-----Adjust water jet from the shower by push it up and down. Besides, shower hose can be stretched out and drew back, so as to make more convenience for client to clean feet.
5. Description of the Hand Controller

1) LCD Display

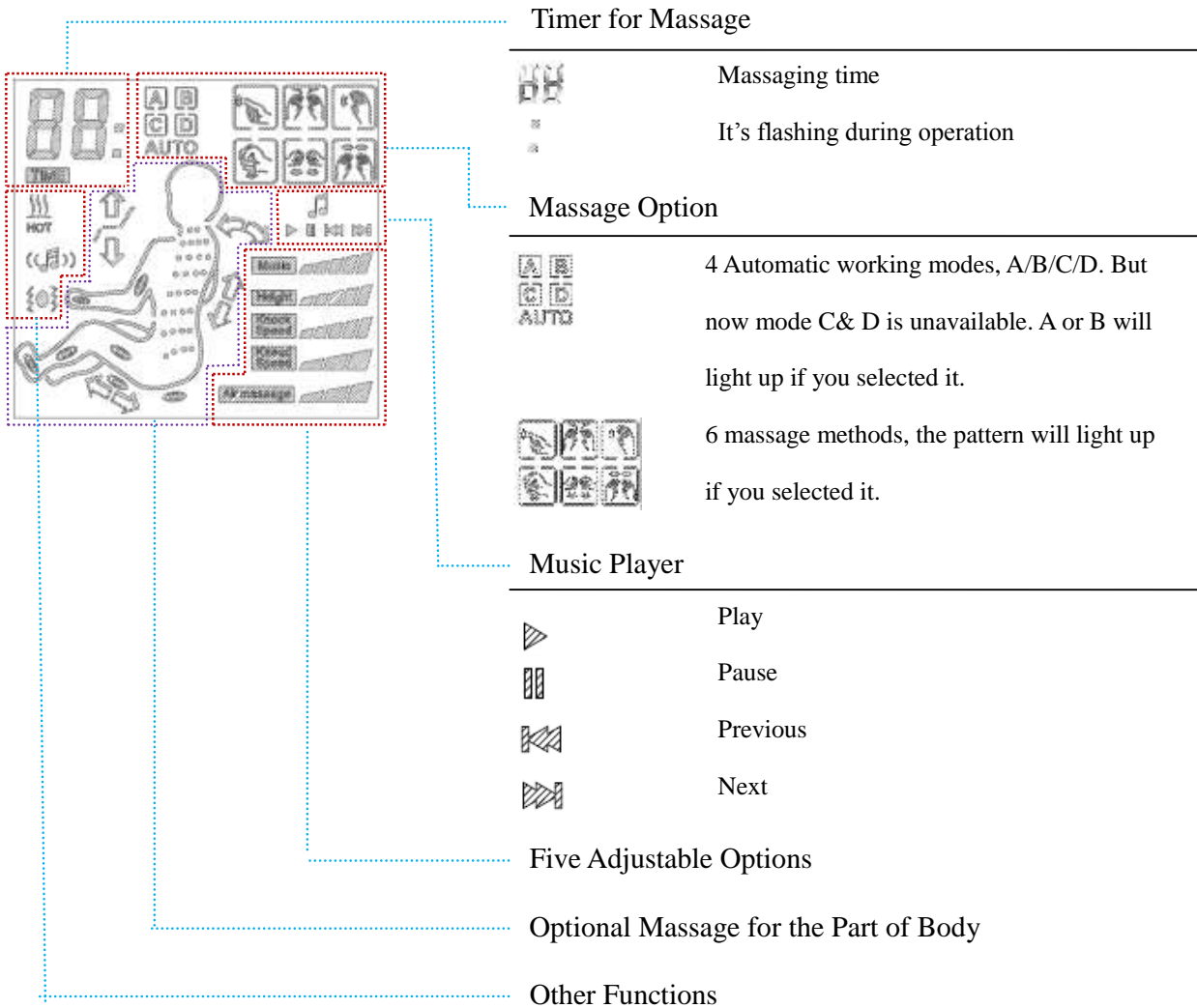

- Adjustable Option



Voice for player



Height of Massage



Speed of Knocking



Speed of Kneading



Intensity of Air Massage

- Optional Massage for the Part of Body



Adjustment for the Height of Seat



Adjustment for the Angle of Backrest



Adjustment for the Angle of Seat



Adjustment for the Massaging area



It lights up when the area is doing air massage



It lights up when the area is doing massage

- Other Functions



Heating system



The intensity of Massage keeps following the rhythm of music



Vibrating

2) Buttons of the Hand Controller

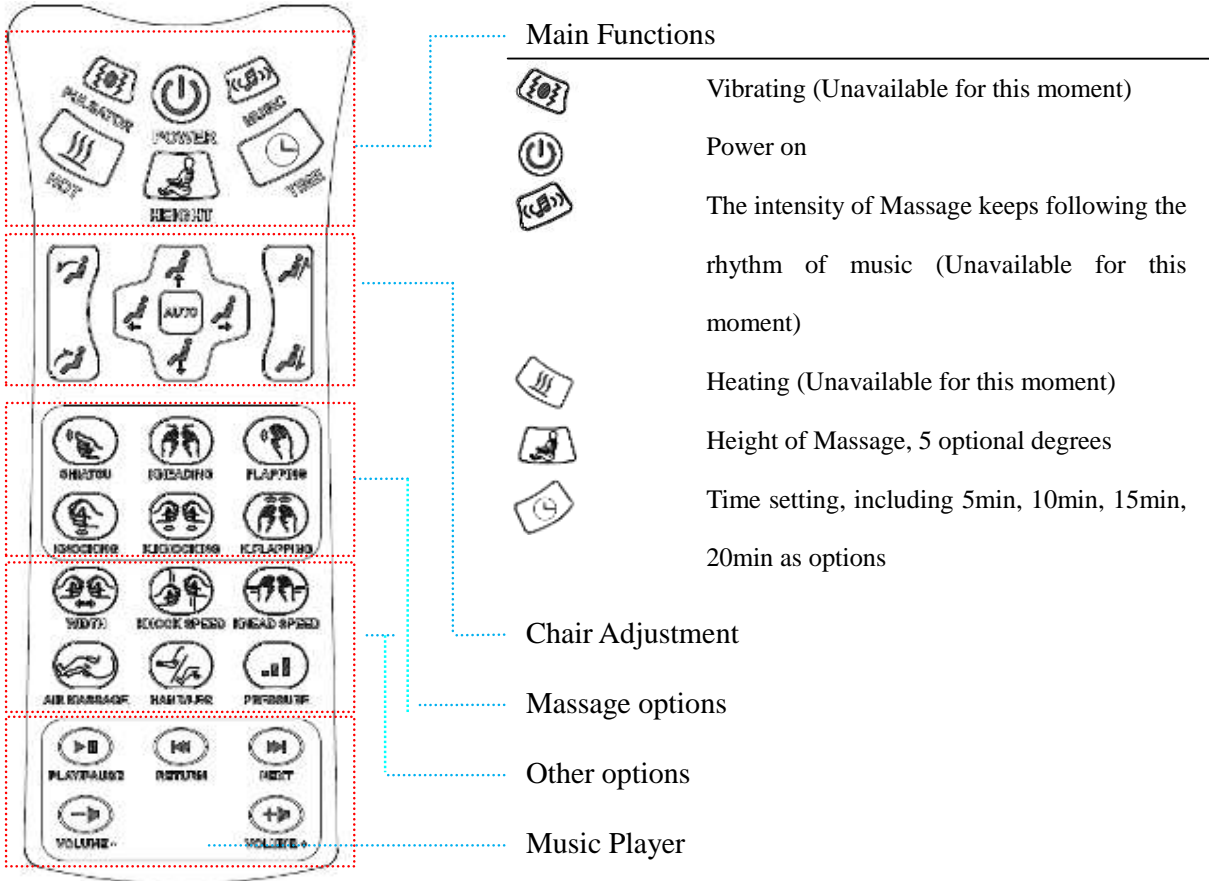

• Chair Adjustment



Button for adjust the angle of backrest. Upper for decrease the angle, bottom for increase the angle. Keep on pressing button to continuously adjust the angle.



- ① Press "AUTO" button for the automatic working mode of A/B.
- ② Upper and bottom are for the up & down of the seat. Keep on pressing either of them to continuously adjust the height.
- ③ Left and right are for the forward & backward of the seat. Keep on pressing either of them to continuously adjust the seat.



Button for adjust the massaging part of the back. 7 massaging positions are as option.

- **Massage Options**



Finger Massage



Kneading



Tapping



Knocking



Kneading + Knocking



Kneading + Tapping

- **Other Options**



The adjustable distance between massaging hands



Knocking Speed, 5 degrees as option



Kneading Speed, 3 degrees as option



Start/ Stop air massage



Optional air massaging area (Unavailable for this moment)



Intensity of the air massage, 3 degrees as option

- **Music Player**



Play/ Pause (Note: Pause the music before plugging/unplugging the USB or SD card)



Previous song



Next song



Voice decreasing



Voice increasing

3. Warning!

[Note: Pay attention on following items to prevent from burn, electric shock, fire and other danger.]

- 1、 Unplug the power cord before do some cleaning.
- 2、 Plug completely into the socket, or else fire or electric shock may occur.
- 3、 Do not stand on the product.
- 4、 This product is unavailable for children. Please keep children away from it. The backrest should go up to Max position when you are away.
- 5、 Keep product away from bathroom or wet place, avoid electric shock or faulty performance. Hand controller should be kept away from water as well.

- 6、 Do not use product in the place where is doing some painting/ coating or oxygen supplying.
- 7、 Switch off the device before unplug the power cord from socket.
- 8、 Do not open or disassemble foot SPA without authorization, so as not to be hurt by electric shock.



4. Cautions on Security!

[Note: In order not to make lives at risk, please pay attention on following items.]

- 1、 People who are under following sickness or having medical treatment should consult with doctor before use..
 - a) Women in Pregnant, people in sick or in poor health.
 - b) People with pain on the back, neck, shoulder or hip.
 - c) People who are implanted cardiac pacemaker or other medical devices which may cause electromagnetic interferences.
 - d) Patients with heart disease
 - e) Patients who are prohibited to having massage due to thrombosis, aneurysm, severe varicosity or other disease of circulation system.
 - f) Patients with curved vertebral column.
 - 2、 Do not put your finger/ toe into the gap between backrest and seat or armrest, even the joint part under seat as well.
 - 3、 It would be better to wear light clothes for treatment. But do not without clothing please. Do not have treatment when you wear something hard on your head.
 - a) Do not massage for over 5min at the first time of using this product. This is to avoid discomfort for muscle. You can increase the intensity or time of massage after some time.
 - b) Do not massage one part of body for over 5min every treatment.
 - c) Massage for overtime or improper intensity might stimulate muscle or nervous system excessively.
 - d) The total massage time has set up to no more than 20min. Four-wheeled massage hand will automatically stop working after 20min.
 - e) Remove the backrest cushion if you would like a massage with stronger effect. But please pay more attention on this way, since it's possible to cause back be painful or hurt. Besides, do not massage in this way for more than 15min each time.
 - 5、 If you feel uncomfortable or painful during massage, please stop massaging.
 - 6、 Do not have treatment after drink.
 - 7、 Massage with minimum intensity and speed at the first time of use. You might make some adjustment after use for some time.
 - 8、 Keep Children away from the foot SPA chair. The backrest should go up to Max position when you are away.
-



5. Cautions on Operation!!

[Note: In order to prevent product from damaging due to improper operation, please pay attention on following items.]

- 1、 The components of foot SPA chair may be damaged if it is over-loaded. So please note that the specifications mentioned as below. Besides, it should be out of warranty if foot SPA chair is damaged due to over-loaded.
 - a) The Max. weight of the client sitting on the chair is 120KG.
 - b) Armrest should not be loaded over 30KG.
 - c) Foot SPA basin should not be loaded over 150KG.
- 2、 Take good care of the hand controller, do not sit on it or drop it down. Armrest shouldn't go up when hand controller is placed on it.
- 3、 Take good care of the upholstery of cushion.
 - a) Keep upholstery away from the sharp things, lighted ash of cigarette, or lighted match.
 - b) Keep upholstery away from direct sunlight, so as to avoid upholstery being discolored or aged.
- 4、 Do not repair foot SPA chair without authorization.
- 5、 Switches and buttons might be defective if you repeatedly switch on/ off in a short time.
6. If the performance of chair is defective or after you repair or replace a new circuit board, you can reinitialize the electric circuit board as following. Press the buttons of  and  on the hand controller at the same time, while power on. Release the buttons until four-wheeled massage hand work. Re-initialization is finished once massage hand stop working.
7. It is normal phenomenon that chair might be sound during operation.
8. Switch off the power after each treatment. [The switch is at the right side of chair, 0 means off]
9. In order not to be shocked by electric or make electric board damaged, please do not open the hand controller and control box without authorization.
10. Unplug the power cord before repair or clean the chair. Clean Chair with soft towel and some water. Please note that organic and volatile solvent shouldn't be used for cleaning.
11. If there is drain outlet on the ground for the basin, you could remove the rubber plug and put the pipe into the outlet during foot SPA. If not, please keep plugging from water leaking. (See photo as below)



12. Signs of Error:

- a) There is “E1/ E2/ E3” showed on the timer  , and it keeps flashing. Meanwhile, all buttons don’t work.
- b) There is “88” showed on the timer  , and it keeps flashing.

Code of Error	E1	E2	E3	88
Issues	Motors for movement are defective	Motor controlled for massage is defective	Four-wheeled massage hand is defective	Hand controller doesn’t connect well with electric circuit board

6. Maintenance

- a) Clean basin with cloth after SPA, so as to extend the lifetime of basin.
- b) If there is dirt or slight scratches on the basin after using for a long time, you could sand it with a #2000 sandpaper and water.
- c) It is unavoidable that basin will be ageing after using for a long time. Replace corresponding parts if necessary. If you found water dropping or leaking, replacing a new sealing gasket and tightening the nut can solve the problem. You may even add some glass cement on the joint if necessary.
- d) Massage Chair might sounds loudly after using for a long time. Add some grease on the four-wheeled massage hand can solve this problem.
- e) Clean with soft towel and some alcohol if there is dirt on the upholstery.

7. Technical Parameter

Power supply	AC110V、220V、240V as option
Input frequency	50-60Hz
Distance between upper and bottom wheels of massage hand	approx 0-600mm
Movement distance of four-wheeled	approx 450mm
Distance between left and right wheels of massage hand	approx 30-200mm
Speed for the movement of massage hand	about 14s per round
Pressure of Air Massage	30~40kPa
Adjustable Angle of Backrest	approx 105-125°
Distance Between forward and backward	approx 0-100mm
Distance Between Up and down	approx 0-100mm (only to 4122C)
Time setting	≤20min
Size of Foot SPA Chair	approx 1650×810×1500mm (Length × Width × Height, Chair isn’t slant)
Packing Size:	Massage Chair: 1180×720×600(mm) Foot SPA base 1470×850×510(mm)