

USER MANUAL OF SMART AC

NOTE:

Company will not be liable for any issues and problems caused by Internet, Wi-Fi Router and Smart Devices. Please contact the original provider to get further help.



CS374U-APP(OSK102)
16122000002774
20151116

CONTENTS

| | | |
|----------|---------------------------------------|-----------|
| 1 | DECLARATION OF CONFORMITY..... | 1 |
| 2 | SPECIFICATION..... | 1 |
| 3 | PRECAUTIONS | 1 |
| 4 | TECHNICAL SOLUTION | 2 |
| 5 | OPERATION INSTRUCTION | 4 |
| 6 | HOW TO USE APP | 13 |
| 7 | SPECIAL FUNCTIONS | 15 |

CAUTIONS

- This device complies with Part 15 of the FCC Rules and RSS 210 of Industry & Science Canada. Operation is subject to the following two conditions: (1) this device may not cause harmful interference, and (2) this device must accept any interference received, including interference that may cause undesired operation.
- Only operate the device in accordance with the instructions supplied. This device complies with FCC and IC radiation exposure limits set forth for an uncontrolled environment. In order to avoid the possibility of exceeding the FCC and IC radio frequency exposure limits, human proximity to the antenna shall not be less than 20cm (8 inches) during normal operation.
- Changes or modifications not expressly approved by the party responsible for compliance could void the user's authority to operate the equipment.

1 DECLARATION OF CONFORMITY

Hereby, we declare that this AC is in compliance with the essential requirements and other relevant provisions of Directive 1999/5/EC. The declaration of conformity may be consulted with sales agent.

2 SPECIFICATION

Model: OSK102
Standard:IEEE 802.11b/g/n
Antenna Type:Wxternal omnidirectional Antenna,
Frequency:WIFI: 2.4G
Maximum Transmitted Power: 15dBm Max
Dimension:55*24*8(mm)
Operation Temperature:0°C~45°C/32°F~113°F.
Operation Humidity:10%~85%
Power Input:DC 5V/300mA

3 PRECAUTIONS

- Applicable system :IOS, Android.
(Suggest:IOS 7.0 or later Android 4.0 or later)
Please check the service website for more applicable devices.
- Disclaimer:Due to the special situation existed during App use,we explicitly claim as bellow:
Not all of the Android and IOS systems are compatible with the APP.We will not be responsible for any issue as a result of the incompatibility SMART KIT wireless safety strategy.
Smart kit Only support WPA-PSK/WPA2-PSK encryption and none encryption .
WPA-PSK/WPA2-PSK encryption is recommended.

- Smart Phone camera needs to be 5 million pixels or above to make sure scan QR code well.
- Due to different network situation, sometimes, request time-out could be happened, thus, it is necessary to do network configuration again.

Due to different network situation, sometimes, control process may return time out. If this situation occurs, do not feel confused, the display on board and APP may not be the same.

4 TECHNICAL SOLUTION

1. WIFI Router Home Control Mode.

A WIFI router is needed at this mode. Smart phone and connect to the AC through the WIFI router conditioner.

- 1) Smart Phone
- 2) Smart Air conditioner
- 3) WIFI Router

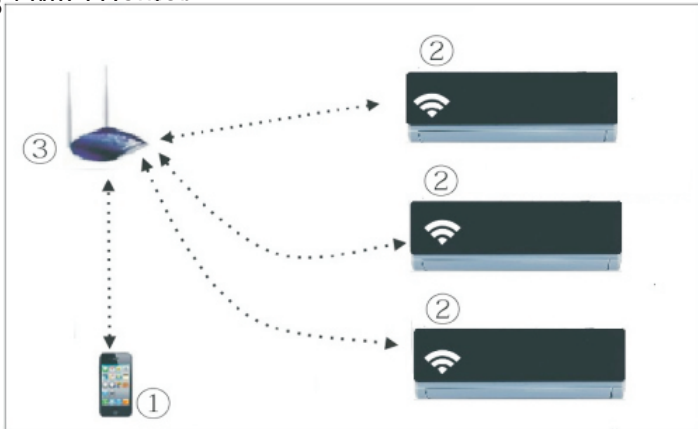

2

2. How to install the smart kit

- ① Remove the protective cap of the smart kit

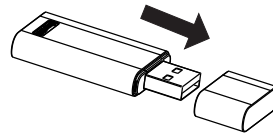

- ② Open the front panel and insert the smart kit into the reserved port
- ③ Attach the QR code packed with SMART KIT to the side panel of the machine, ensure it is convenient to be scanned by the mobile phone.

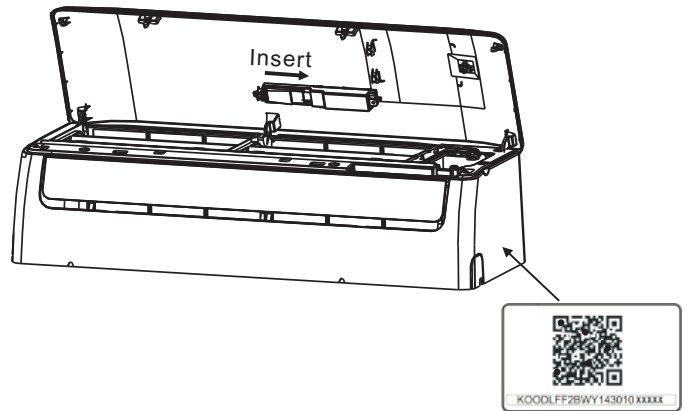

3

5 OPERATION INSTRUCTION

1.Install App

- 1).**Iphone Users**:scan QR Code or go to App Store and search for 'NetHome Plus' app and download it.
- 2).**Android Phone users**:scan QR Code or go to google play, search for 'NetHome Plus' app and download it

2.Set Air conditioner to be AP mode

The procedure includes the following steps:

- 1) Disconnect the power supply of AC
- 2) Connect the power supply of AC, and continuously press the digital display button or do not disturb button seven times in 3 minutes.
- 3) When the AC displays 'AP', it means that the AC WIFI has already entered into the WIFI Network Setting Mode.

Kindly reminder:

- When the AC WIFI entered into WIFI Network Setting Mode, the Air-conditioning remote control can't open the AC. It needs to wait 3-5 minutes or when the AC finishes the WIFI Network Setting Mode, then the Air-conditioning remote control can control AC normally.
- If there is no set operation under WIFI Network setting mode,AC will quit this mode automatically 8 minutes later ,and then the user can control the AC normally.

4

3.User Registration and Network Configuration

- Please ensure your mobile device is connected to Wifi router. Also, the Wifi router has already connected to Internet before doing user registration and network configuration.

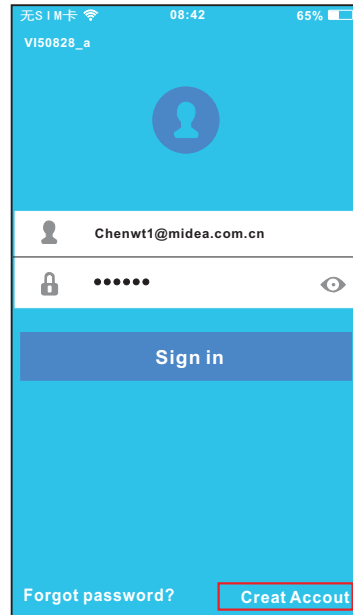

① Click 'Creat Account'

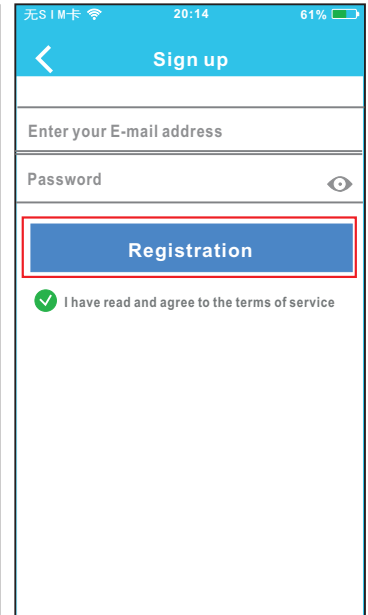

② Enter your email address and password, and then click 'Registration'.

5

CAUTION:

- It is better to log in your email box and active your registration account by clicking link in case you forget the password.
- It is necessary to forget any other around network and make sure the Android or IOS device just connect to the WIFI network you want to configure.
- Make sure the Android or IOS device WIFI function works well and can be connected back to your original WIFI network automatically.

■ Using Android device to do Network configuration

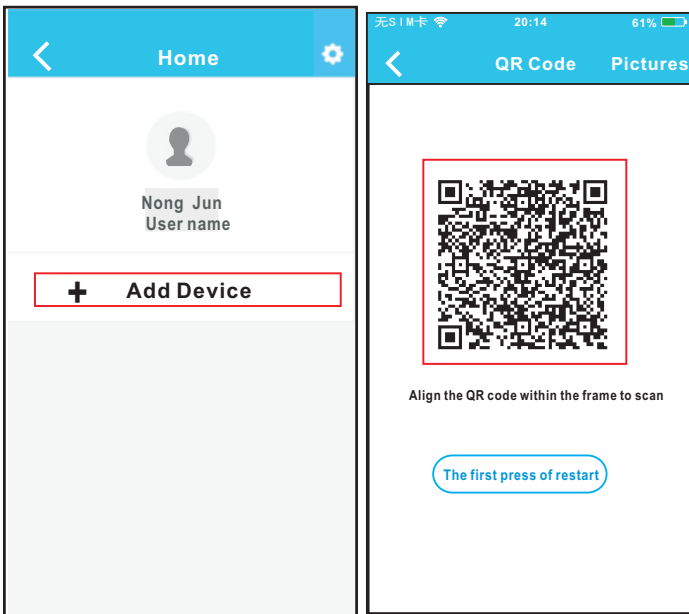

③ Press '+ Add Device'

④ Scan QR Code

6

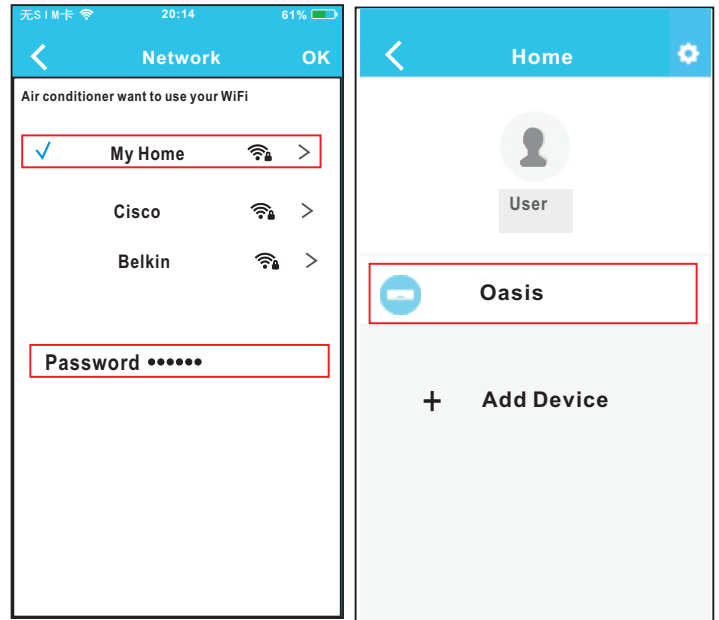

⑤ Select your own WiFi network, for example My Home (the picture is only for reference)

⑥ Enter your own WiFi router password and click OK;

⑦ Configuration Success, you can see the device on the list.

7

■ Using IOS device to do Network configuration

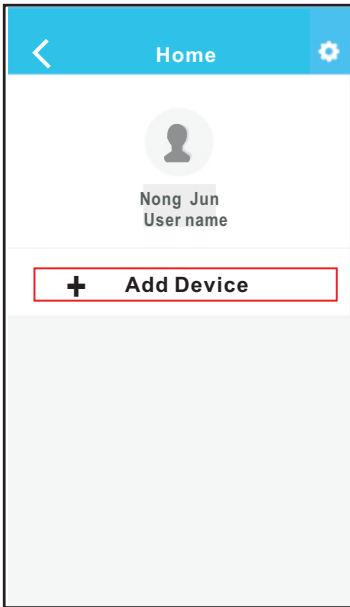

③ Press '+ Add Device'

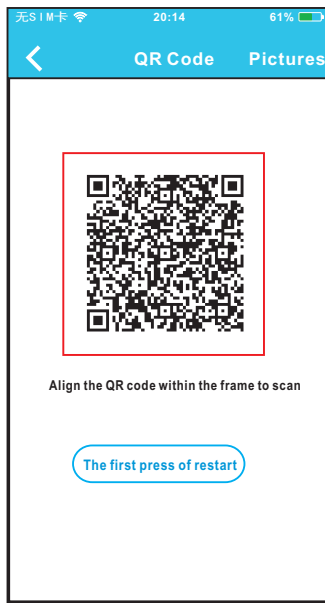

④ Scan QR Code

8

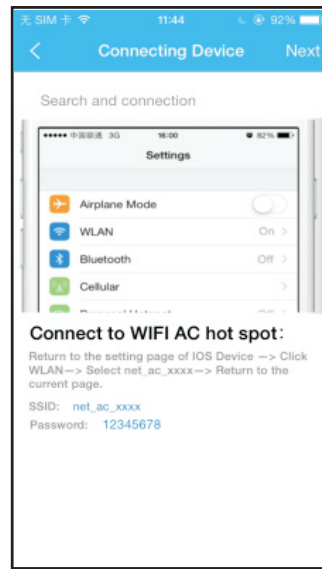

⑤ Read the instruction above and press the 'Home' button to return to the device interface.

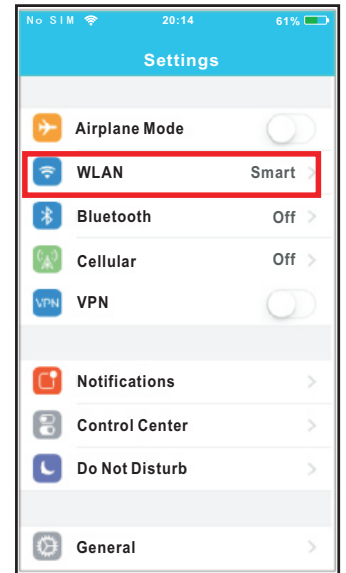

⑥ Click settings to enter the setting page, select WLAN/WIFI.

9



⑦ Choose net_ac_XXXX



⑧ Type default password: 12345678 and click "Join "

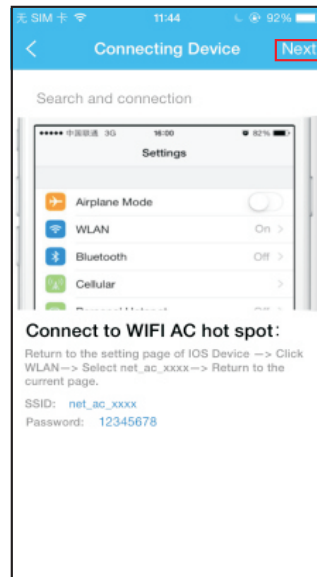

⑨ Return to APP and click Next

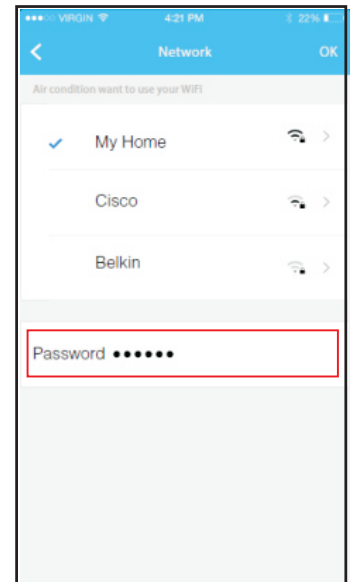

⑩ Select your own WiFi network, for example My Home (the picture is only for reference)

⑪ Enter your own WiFi router password and click OK;

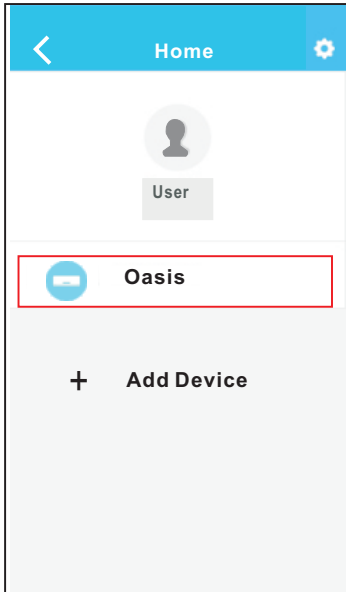

⑫ Configuration Success, you can see the device on the list.

NOTE:

When finishing network configuration, APP will display success cue words on the screen. Due to different Internet environment, it is possible that the device status still display "offline". If this situation occurs, user should turn off the AC power and turn on it again. After a few minutes, it is necessary to do pull-refresh operation to make sure the device status become "online".

⑫

6 HOW TO USE APP

Please ensure both your mobile device and air conditioner are connected to the Internet before using app to control the air conditioner via internet, please follow the next steps:

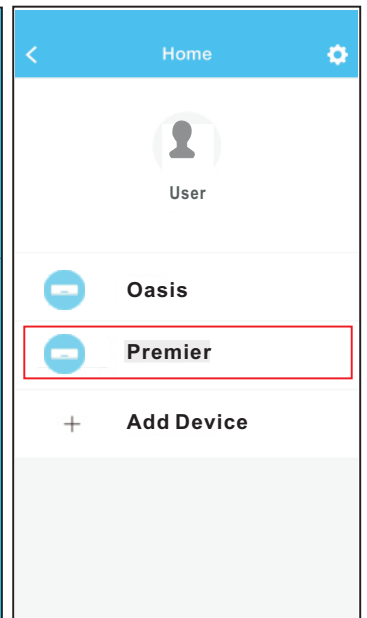
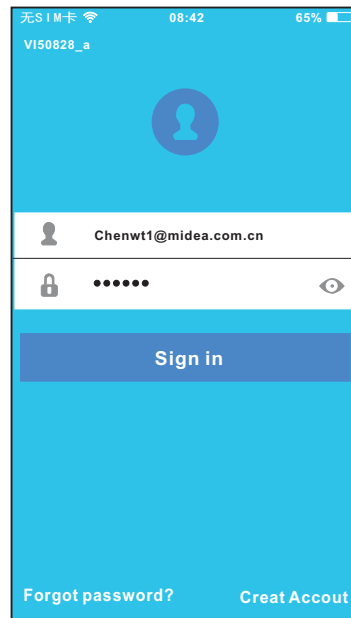

① Type your own account and password, Click "Sign in"

② Select the target air conditioner to enter into the main control interface.

⑬

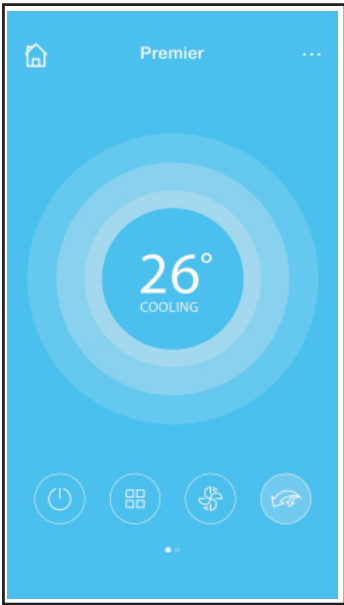

③ Thus, user can control air conditioners on/off status, operation mode, temperature, fan speed and so on.

NOTE:

Not all the function of the APP is available on air conditioner. For example: ECO, Turbo, Left and Right Swing, Up and Down swing function, please check the user manual to find more information.

7 SPECIAL FUNCTIONS

Including: Timer on, Timer off, 8°C Heat, Sleep, Energy, Check.

NOTE: If the air conditioner do not support the above function, the function will be hidden from the function list.

■ **Timer on/ Timer off**

Weekly, user can make an appointment to turn on or off AC on specific time. User also can choose circulation to keep the AC under schedule control every week.

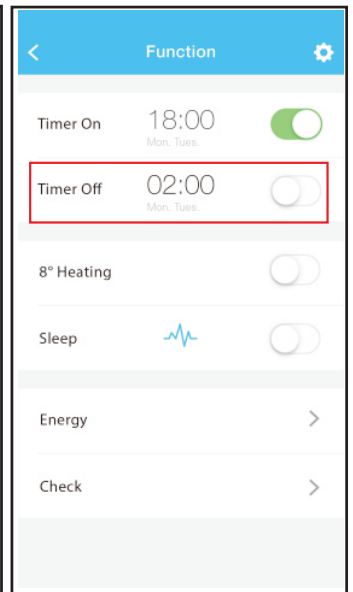
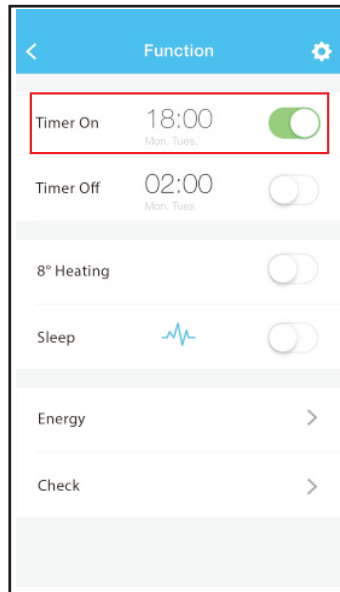

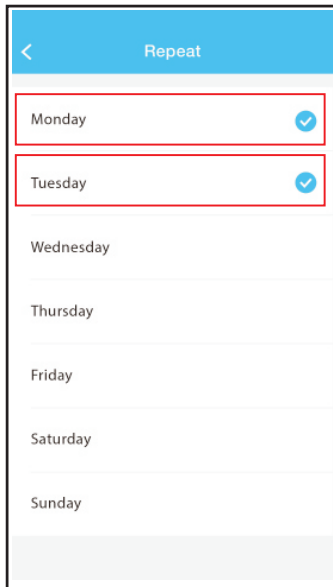
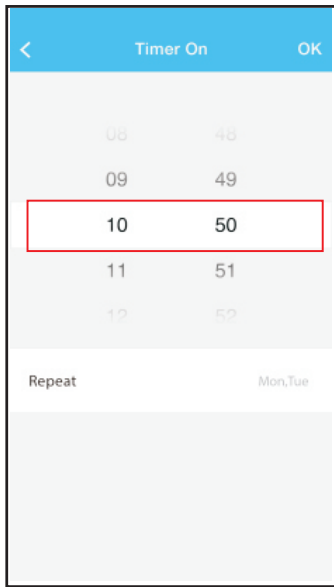

■ 8°C Heat

User can let the AC run under 8°C Heat by one-click. When people go outside, this function can protect your furniture from frost damage.

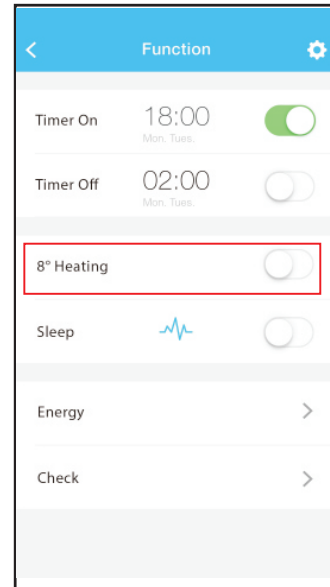

■ Sleep

User can customize their own comfortable sleep by setting target temperature.

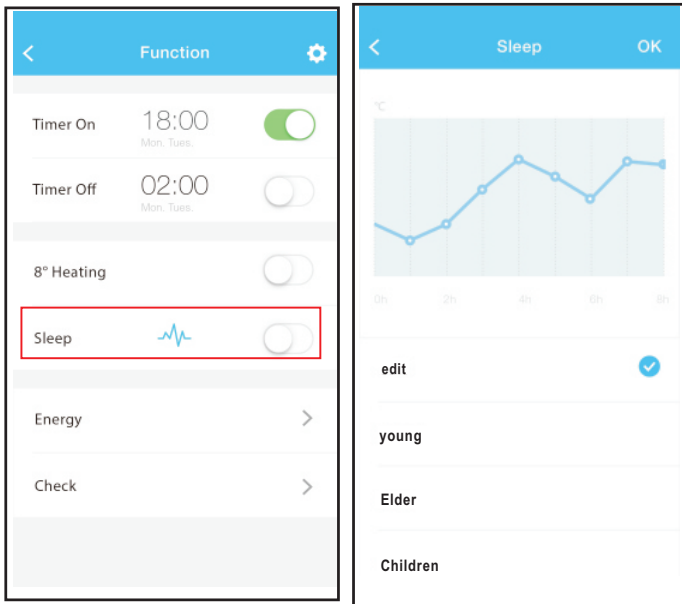

18

■ Check

User can simply check the AC running status with this function. When finishing this procedure, it can display the normal items, abnormal items, and detail information.

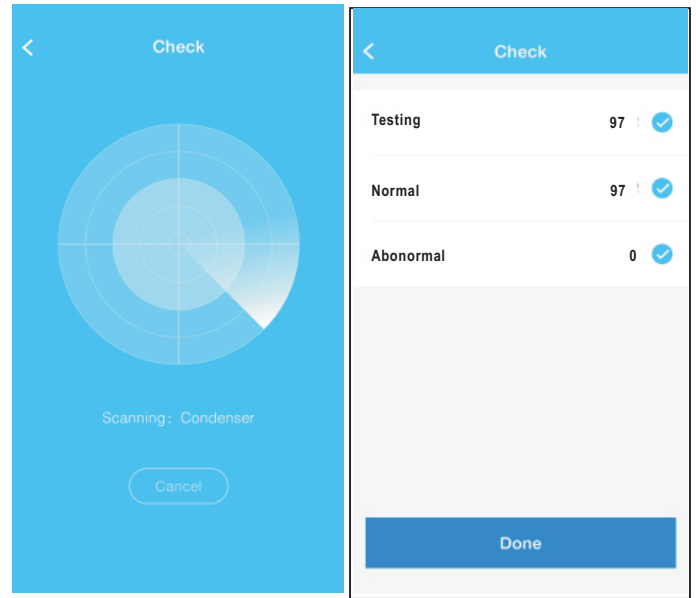

19

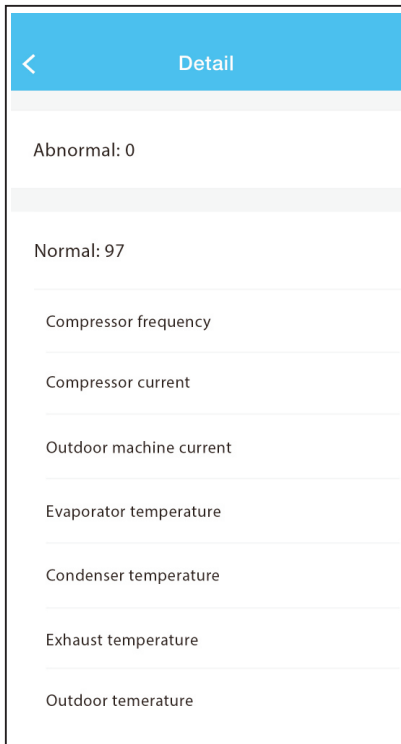

■ Energy

User can see the electricity curve monthly, and find the Lowest and highest cost per month.

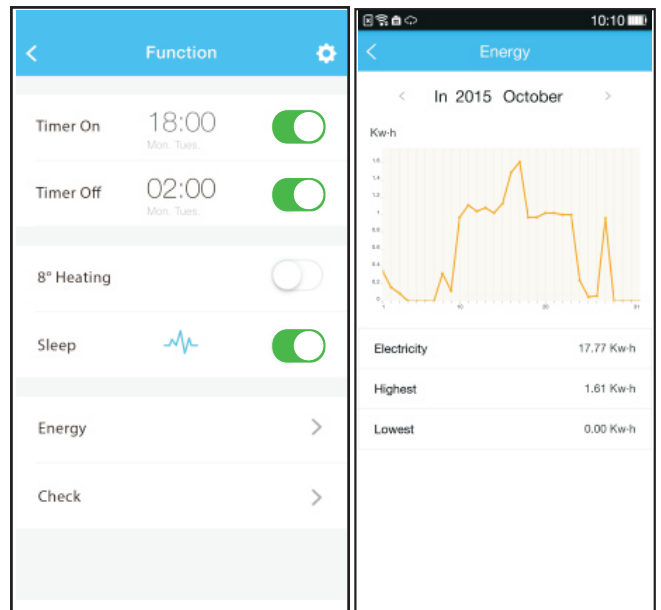



VIVAX

www.VIVAX.com