

Guide to Using the Instructions Booklet

Dear customer, We are delighted that you have put your trust in us.

We are confident that the new hob that you have purchased will fully satisfy your needs. This modern, functional and practical model has been manufactured using top-quality materials that have undergone strict quality controls throughout the manufacturing process.

Before installing and using it, we would ask that you read this Manual carefully and follow the instructions closely, as this will guarantee better results when using the appliance.

Keep this Instruction Manual in a safe place so that you can refer to it easily and thus abide by the guarantee conditions.

In order to benefit from this Guarantee, it is essential that you submit the purchase receipt together with the Guarantee Certificate.



You should keep the Guarantee Certificate or, where relevant, the technical datasheet, together with the Instruction Manual for the duration of the useful life of the appliance. It has important technical information about the appliance.

Safety instructions

Before first use, you should carefully read the installation and connection instructions.

These hob models may be installed in the same kitchen furniture units as **TEKA** brand ovens.

For your safety, installation should be

carried out by an authorised technician and should comply with existing installation standards. Likewise, any internal work on the hob should only be done by **TEKA's** technical staff, including the change of the flexible supply cable of the appliance.

Safety warnings:



If the ceramic glass breaks or cracks, immediately unplug the stovetop to avoid electric shocks.



This appliance is not designed to work with an external timer (not built into the appliance) or a separate remote control system.



Do not steam clean this device.



The device and its accessible parts may heat up during operation. Avoid touching the heating elements. Children younger than 8 years old must stay away from the stovetop unless they are permanently supervised.



This device may solely be used by children 8 years old or older, people with impaired physical, sensory or mental abilities, or those who lack experience and knowledge, ONLY when supervised or if they have been given adequate instruction on the use of the device and understand the dangers its use involves. User cleaning and maintenance may not be done by unsupervised children.





Children must not play with the device.





Precaution. It is dangerous to cook with fat or oil without being present, as these may catch fire. Never try to extinguish a fire with water! In this event disconnect the device and cover the flames

with a lid, a plate or a blanket.

 Do not store any object on the cooking areas of the stovetop. Prevent a possible fire hazard.

 Do not place metal objects, such as knives, forks, spoons or lids on the surface of the hob, as they may get very hot.

 The induction generator complies with all current European standards. Nonetheless, we recommend that people with heart devices, with such as artificial pacemakers, consult with their doctor or, if in doubt, refrain from using the induction zones.

 It is advisable not to use the induction hob during the pyrolitic cleaning function in the case of the pyrolitic ovens, due to the high temperature reached by this appliance.

 When finished, turn off the cooking zone by using the touch controls. Otherwise an undesired operation could occur if a pan is accidentally placed on the cooking zone during the next three minutes. Avoid possible accidents!

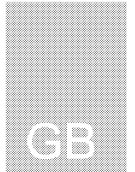

Installation

INSTALLATION AND SETUP SHOULD BE CARRIED OUT BY AN AUTHORISED TECHNICIAN IN LINE WITH CURRENT INSTALLATION STANDARDS.

Positioning the hob

GB

To install these models, an opening with the dimensions shown in figure 1 will be cut into the unit's worktop.

The fastening system for the top is designed for furniture thicknesses of 20, 30 and 40 mm.

The minimum distance between the surface supporting the cooking pans and the lower part of the kitchen unit or the hood located above the hob should be 650 mm. If the hood's installation instructions recommend that the gap is greater than this, you should follow this advice.

The unit where the hob and oven will be located will be suitably fixed.

INSTALLATION WITH FAN OVEN UNDER THE HOB

The oven should be installed according to the corresponding manual.

If a fan oven is being installed, please remember that this hob has only been certified to work with TEKA brand ovens.

An opening of 20 mm should be made in the back part of the cabinet in order to allow cold air to enter (see figure 1).



When hobs are handled before being installed, care should be taken in case there is any protruding part or sharp edge which could cause injury.



When installing units or appliances above the hob, the hob should be

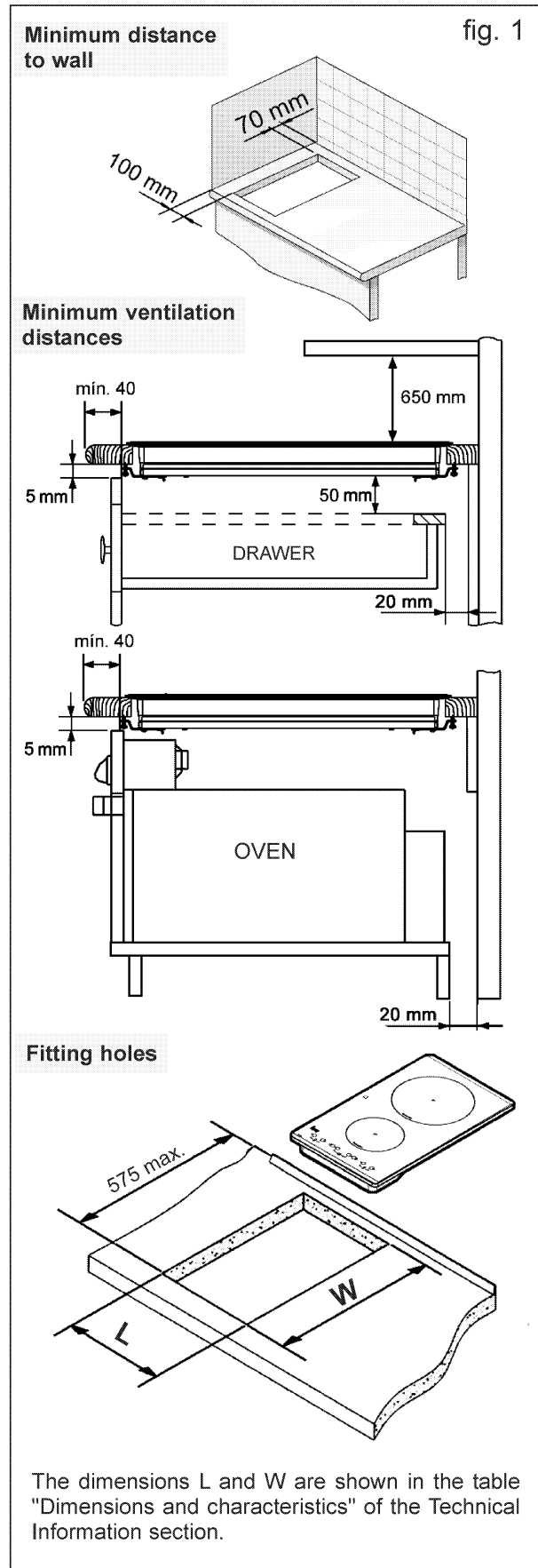
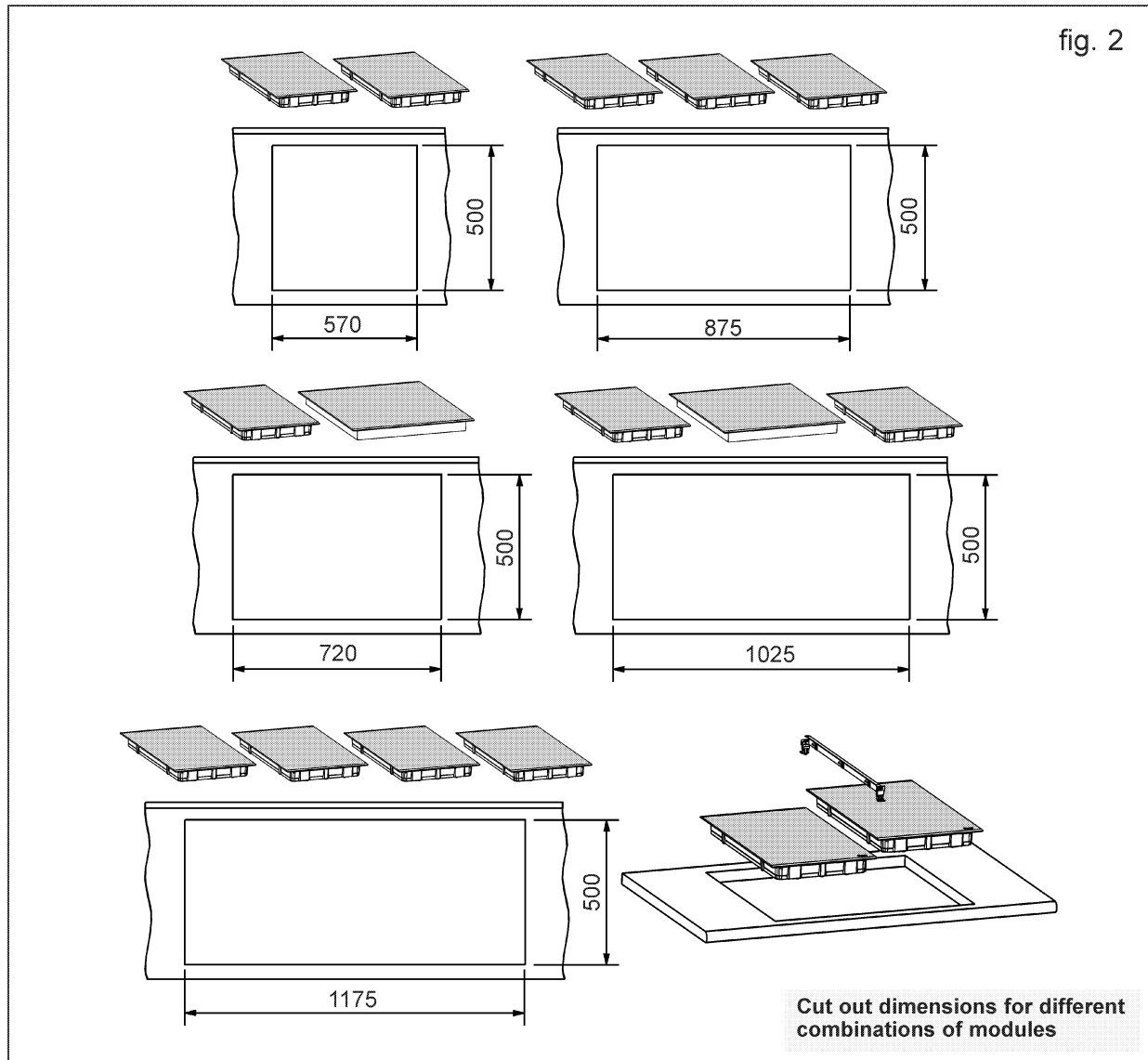



fig. 2



protected by a board so that the glass cannot be damaged by accidental blows or heavy weights.

 The glues used in manufacturing the kitchen unit and in the adhesive on the decorative laminate of the worktop surface should be made to tolerate temperatures of up to 100°C.

 TEKA assumes no responsibility for any malfunction or damage caused by faulty installation.

PLEASE REMEMBER THAT THE GUARANTEE DOES NOT COVER THE

GLASS IF IT SUFFERS A VIOLENT BLOW OR IF IT IS USED IMPROPERLY.

Fastening the hob

When the gap has been properly sized, the sealing washer should be put on the lower face of the glass. **Silicone should not be applied between the glass and the unit worktop because if it becomes necessary to remove the hob from its position, the glass could break when trying to detach it.**

To secure the hob to the cabinet, four brackets should be fastened to the existing holes

on the bottom part of the casing (two in the front and two in the back). There are two possibilities of where the brackets may be placed, just as is shown in figure 3.

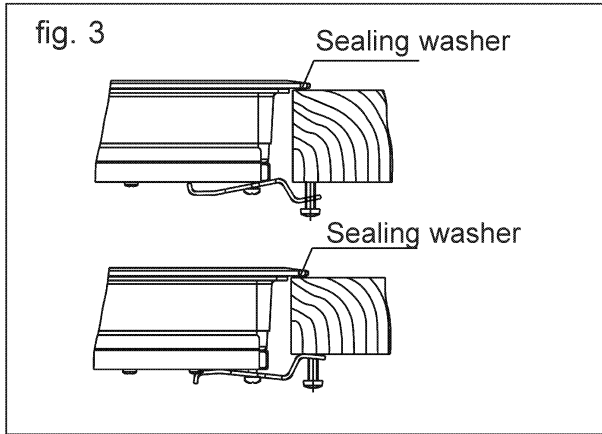

Depending on the thickness of the cabinet, it may be necessary to use the self tapping screws that are provided as compliments for securing; insert them in the circular holes of the bracket. The thread of this hole will be made when the screw is inserted inside of it. The thread should be made before fastening the bracket to the hob.

Connecting the electricity

The electric connection is made via an omnipolar switch or plug where accessible, which is suitable for the intensity to be tolerated and which has a minimum gap of 3 mm between its contacts, which will ensure disconnection in case of emergency or when cleaning the hob.

If the flexible supply cable fitted to these appliances ever needs to be changed, it should be replaced by TEKA's official service. The input cable should not be in contact either with the body of the hob or with the body of the oven, if the oven is installed in the same unit.

⚠ When using the hob for the first time, please take care not to have

powerful halogen lights, like those of a hood, shining over the sensor button area of the hob. These lights may interfere with the starting of the system.

⚠ The electrical connection must be properly grounded, following current regulations, otherwise the stovetop may malfunction.

⚠ Unusually high power surges can damage the control system (like with any electrical appliance).

Technical Information

Technical details

Class 3 hob.

Dimensions and characteristics

Model	IR 321 IB 321	IR 421
Hob dimensions		
Height (mm)	60	60
Length (mm)	520	450
Width (mm)	300	520
Dimensions of the placement in the unit		
Length (mm) (L)	500	420
Width (mm) (W)	270	500
Depth (mm)	55	55
Configuration		
Induction hotplate 1,100 / 1,800* W	1	1
Induction hotplate 2,100 / 3,000* W	1	1
Electrics		
Nominal Power (W) for 230 V	3.200	3.200
Supply voltage (V)	230	230
Frequency (Hz)	50/60	50/60

* Induction power with the Power function enabled.

GB

Use and Maintenance

Touch control user instructions

CONTROL PANEL ELEMENTS (see fig. 4)

- GB
- ① On/off sensor.
 - ② Hotplate indicators.
 - ③ Power and/or residual heat indicators.
 - ④ Reduce power sensor (less).
 - ⑤ Increase power sensor (more).
 - ⑥ Timer/Clock indicator.
 - ⑦ Indicator of selected time (clock).
 - ⑧ Locking sensor (for the rest of the sensors, except on/off).
 - ⑨ Indicator light of the induction element with timer.
 - ⑩ Pilot light for activated locking.
 - ⑪ Time reduction sensor on clock (less).
 - ⑫ Time increasing sensor on clock (more).
 - ⑬ Countdown indicator (blinks each second).

N.B.: * Only visible when in operation.

The sensors marked on the control panel are used for control purposes.



There is no need to exert pressure on the glass - you enable the function you require simply by touching the sensor with your finger.

Each action is confirmed by a beep.

SWITCHING THE APPLIANCE ON

- 1 Touch the on sensor  (1) for at least one second. The Touch Control will activate, you will hear a beep and the indicators will turn on. If any of the cooking areas is hot, the corresponding indicator will alternate between showing a H and a 0.

The following action must be carried out within 10 seconds or the touch control will automatically switch off.



When the touch control is activated, it can be disconnected at any time by touching the sensor  (1), even if it has been blocked (blocking function activated). The sensor  (1) always takes priority for disconnecting the touch control.

SWITCHING THE HOTPLATES ON

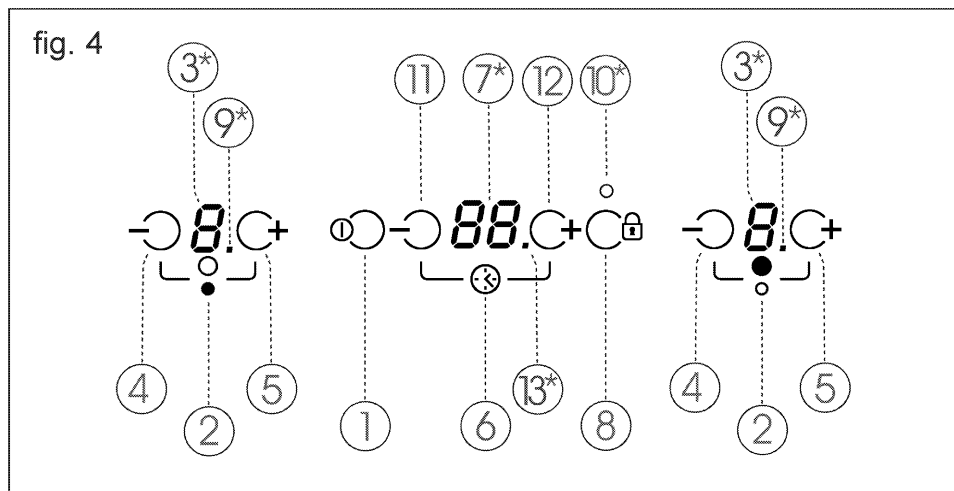

The hotplates will be found deactivated, with their respective power indicators (3) at 0, until a power level is selected. If all the hotplates are set at 0, you have 10 seconds to activate any of them, otherwise the touch control will automatically turn off.

Use the sensors  and  (4/5) to select



a power level. If you touch the sensor  (5), the plate will switch to level 1 and, for each additional stroke, it will go up one level until reaching the maximum value of P. Using the sensor  (4), you can reduce the power level.



For a fast powering up at maximum power: with the plate at 0, touch the sensor  (4) once. The plate will directly activate at level 9.

By continuing to press down on any of these two sensors  (4) or  (5), they will repeat the action every half a second, without needing to press consecutively.

SWITCHING THE HOTPLATES OFF

With the sensor  (4), lower the power to level 0.

The hotplate will automatically power off.

For a fast power up: no matter what the power level, by simultaneously pressing the sensors  and  (5/4), the plate will immediately power off.



By powering off a hotplate, an H will be shown on the power indicator, if the glass surface is at a high temperature, indicating that there is a risk of burning. When the temperature has fallen, the indicator will power off if the top is disconnected or, if it is turned on, it will indicate a 0.

POWERING OFF THE DEVICE

At any time, you can disconnect the top by pressing the sensor  (1). When doing this, an acoustic signal is heard and the power indicators (3) will turn off, except if there is a residual H heat indicator active due to the plate temperature.

Locking the sensors

Using the locking sensor  (8), you can block all the sensors on the touch control panel. This will make it possible to avoid undesired accidental operations occurring or children being able to manipulate the control.

Bear in mind that with the touch control powered up, the on/off sensor  (1) makes it possible to turn it off even if the locking is activated (pilot 10 on). On the other hand, if the touch control is turned on, the locking function does not allow for activating the on/off sensor  (1). You should first deactivate blocking.

To activate or deactivate the function, simply keep pressing the sensor  (8) for about 1 second. When the function is active, the pilot light (10) turns on.

Detecting pans (induction hotplates)

The induction cooking plates incorporate a container detector. This is to avoid the plate operating without having a pan on top or when the container is unsuitable, e.g., if made of aluminium or another non-metallic material.

The power indicator blinks if, with the plate turned on, no pan or an inappropriate pan is detected.

If the pans are removed from the hotplate while operating, this will automatically cut off the power supply and the power indicator will blink. When putting the pan on the cooking hotplate again, the power supply restarts at the power level that was selected.

The time for detecting the pan is 3 minu-

tes. If three minutes go by without having placed a pan on the hotplate or if an inappropriate one is placed there, the cooking plate deactivates.

Power supplied according to the power level selected

Bear in mind that induction areas adjust the amount of power supplied according to the size and type (material) of pan placed on them. A smaller pan will receive less power than a larger one. Thus, depending on the pan being used, the power supplied may vary from the values shown in Table 1.

Table 1

Power selected	INDUCTION HOTPLATES Power in watts*	
	Ø 210 mm Hotplate	Ø 145 mm Hotplate
0	70	40
1	110	70
2	150	100
3	240	140
4	380	200
5	600	300
6	850	450
7	1100	600
8	1550	800
9	2100	1100
P	3000	1800

*The exact power will depend of the size and shape of the pan.

Power function

This function makes it possible to give a plate "extra" power, higher than the nominal. This power level depends on the size of the plate (see values indicated with * in the Presentation section), being possible to reach the maximum allowed by the generator.

POWER FUNCTION CONNECTION

- 1 Activate the plate corresponding to power level 9.
- 2 From power level 9, press the sensor  and the symbol P will be displayed on the indicator.

The Power function lasts for a maximum of 10 minutes. After this time, the power level will automatically set to level 9.

POWER FUNCTION DISCONNECTION



The Power function can be disconnected by pressing the sensor  associated with the hotplate in question.



The function can also be disconnected automatically if the temperature in the cooking area is very high.

Fondue function

This function is especially designed for melting butter, cheese, chocolate, etc. It is a lower power level than level 1.

To access this function:

- 1 Activate the plate you wish to use at power level 1.
- 2 Press the sensor  (4) and the indicator will show the symbol .

To deactivate the function, simply touch the sensors  (4) or  (5) and the indicator will display, respectively, a lower power level 0 or higher 1.

Safety disconnection

MAXIMUM FUNCTION TIME

In the event of forgetting to turn off the plate,

it will automatically power off after a given time after the last time the plate was activated. (See Table 2).

Table 2

Power selected	MAXIMUM OPERATION TIME (in hours)
0	8
1	8
2	5
3	4
4	4
5	3
6	3
7	2
8	2
9	1
	10 minutes

When the "safety disconnecting" has occurred, in the corresponding plate's power indicator the residual heat H indicator will be displayed, if the glass temperature is high enough.

SAFETY WHEN SENSORS ARE COVERED

The Touch Control incorporates a function that detects when any object (pan, cloth or certain liquids) are covering the panel sensors for more than 10 seconds. This is to avoid the object activating or deactivating any of the plates without you realizing.

When the Touch Control detects an object covering the sensors, it starts to bleep until the object covering the control panel is removed. If the Touch Control was turned on, it is automatically disconnected for safety reasons.

If after a few minutes the object covering

the sensors is not removed, the beeping will stop.

 **Take into account that this safety function is activated even though the Touch Control is turned off!**

 **Do not leave any objects down on the Touch Control!**

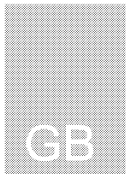





Clock



The top is fitted with a clock that can be used for two different functions: as a plate timer or as a countdown chronometer.



The clock as a countdown timer

With this function, you can set a time after which a sound signal will be heard.

To activate this function, proceed as follows:

- 1 With the Touch Control powered on and no plate with the timer activated, touch one of the sensors  (11) or  (12) corresponding to the clock.
- 2 Power on the indicator (7), displaying 00.
- 3 Touch the sensors  (11) or  (12) again to set the required time. After a few seconds, the decimal point on clock will start to blink (13), indicating that the countdown has begun.

Be careful not to touch different sensors other than  (11) or  (12) since, by doing so, a plate may cease timing instead of programming the chronometer.

Once the countdown has reached zero, a series of beeps will be heard. These can be cancelled by touching any of the sensors  (11) or  (12) associated with

the clock.

If, while the clock is working as a count-down chronometer, at some point the induction plates are set at power level 0, the touch control panel will turn off after a few seconds, but the chronometer will continue working until it finishes the count-down or the countdown is cancelled.

To cancel the chronometer, simply set the remaining time to 00.

Timer function

This function will help you with cooking as you will not have to be present during the following: the timer plate(s) will automatically turn off at the end of the set time. The device has an individual timer for each plate. This allows it to time all the plates at the same time, if required.

The function is controlled with the time increase/decrease sensors \ominus and \oplus (11/12) associated with the clock (7).

SINGLE plate timer

To activate the timer on one single plate, proceed as follows:

- 1 With the plate powered on and the clock turned off, touch one of the sensors \ominus (11) or \oplus (12) corresponding to the clock.
- 2 Turn on the indicator (7) displaying 00. At the same time, a blinking t will appear on the indicators for each of the plates that are powered on.
- 3 In the next 5 seconds, touch one of the sensors \ominus (4) or \oplus (5) corresponding to the plate you wish to time. The t will be set on the indicator for this plate and the digits on the clock indica-

tor (7) will start to blink.

- 4 You have a further 5 seconds to select the time required, simply by touching the sensors \ominus (11) or \oplus (12) on the clock. After a few seconds, the digits on clock indicator (7) will stop blinking and the decimal point on the clock and the timed plate will start to blink, indicating that the countdown has started.

Once the required time has been set, be careful not to activate any other sensor since the device may interpret that you wish to exit the timer function. While the clock digits blink, you can alter their value but do not touch different sensors other than \ominus (11) or \oplus (12).

Once the countdown is complete, the timed plate will power off and a series of beeps will be heard that can be cancelled by touching any of the sensors \ominus (11) or \oplus (12) associated with the clock.

Timing more than one plate / Altering the programmed time

During a countdown, you can alter the remaining time or time a new plate.

- 1 With the Touch Control powered on and a plate timed, touch one of the sensors \ominus (11) or \oplus (12) corresponding to the clock.
- 2 The countdown will stop and the indicator (7) displays 00. A blinking t will display on the indicators for each of the plates that are powered up.
- 3 At that point, you can time another plate or alter the remaining time on a previously time set plate. To distinguish them, **take into account the decimal point appearing on the bottom right**

of the indicator (3), only on that/those plate/s that are timed at that moment.

In the next 5 seconds, touch one of the sensors \ominus (4) or \oplus (5) corresponding to the plate that you wish to time or alter. The \ominus will stop blinking in the indicator for this plate and the digits on the indicator (7) of the clock will start to blink.

- 4 Touch the sensors \ominus (11) or \oplus (12) again until the required time is set. After a few seconds the decimal point in the indicator (7) will start to blink, indicating that the countdown has started.

If you wish to cancel a timing already set, simply set the time desired in step 4 to 00 or, directly, by turning off the plate in question.

When you have timed more than one plate, by default, the indicator (7) of the clock will display the shortest remaining time. This time will correspond to the plate whose indicator (3) displays the \ominus blinking with the decimal point.

Remember that the decimal point in a power indicator (3) shows you that this plate is timed! If this decimal point is blinking and it's shown the \ominus , it means that the indicator (7) of the clock is showing you, at that precise moment, the time remaining in the countdown for that hotplate.

 **Please remember that if, during the countdown, you turn off the touch panel using the on/off sensor button \ominus (1), the countdown will be cancelled!**

Overheating safety feature

The induction areas are protected against overheating that may cause damage to the electronic system.

The internal fan is automatically enabled

and disabled, depending on the temperature of the electronic system. Therefore, the fan may continue to work for a few minutes to cool the electronics if you switch the cooker off when the fan is switched on.

Power surges

 **Touch controls can withstand a certain degree of power surges in the electricity supply. Abnormally high power surges can cause the control system to malfunction (as with any type of electrical appliance).**

Suggestions and recommendations

To ensure maximum performance from your hob, follow these guidelines:

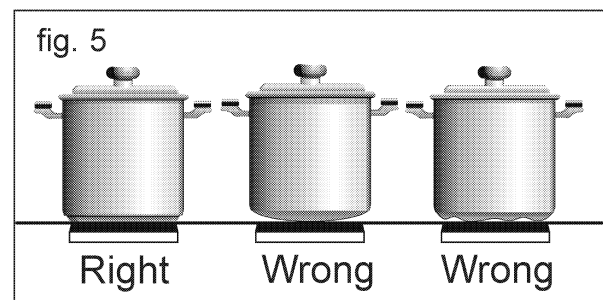

* Use pans with a flat base, as the greater the surface contact between the pan and the glass, the greater will be the heat transmission. We recommend the use of heavy pans so that the base is more difficult to dent. Figure 5 shows how pans that are dented or concave have a smaller contact surface.

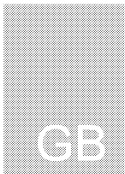

- * Make sure that the pans are well centred on the outlines shown on the heating area.
- * Dry the pans' bases before putting them on the glass ceramic hob.
- * Do not drag pans with corners or edges that could damage the glass.
- * The glass withstands some impacts from large containers with no sharp edges. Be careful with impacts from small and sharp utensils.
- * Avoid spilling sugar, or products containing sugar, on the glass, since these may react with the hot glass and damage the surface.



When you cannot turn off a hot-plate because a cream, a soup or something similar has boiled over, soak a cloth in water and wipe it over the touch control, cleaning off the food, and keep the cloth on the On/Off sensor so that the touch control disconnects.

Cleaning and care

To maintain the glass ceramic hob in good condition, it should be cleaned with suitable products. The glass ceramic hob should be cleaned after each use, when it

is lukewarm or cool. This will make cleaning easier as it will avoid any build-up of dirt from repeated use.

Never use aggressive cleaning products or products that can scratch the surfaces (see the table that shows various common products that may be used). Steam-based appliances should not be used to clean the hob.

LOOKING AFTER THE GLASS

The degree of soiling should be taken into account when cleaning, and the items and products used should vary according to this.

Light soiling

Light, non-sticky, soiling can be cleaned with a damp cloth and a soft detergent or warm, soapy water.

Heavy soiling

Serious dirt and grease should be cleaned using an agent specially made for glass ceramic. Please follow the manufacturer's instructions.



RECOMMENDED CLEANING PRODUCTS

Product	Should it be used to clean...	
	...the glass?	...the surround?
Soft and liquid detergents	YES	YES
Aggressive or powder detergents	NO	NO
Special glass ceramic cleaning agents	YES	YES
Grease-removing sprays (ovens, etc.)	NO	NO
Soft cloths	YES	YES
Kitchen towels	YES	YES
Kitchen cloths	YES	YES
Nickel scourers (never use dry)	YES	NO
Steel scourers	NO	NO
Hard synthetic scourers (green)	NO	NO
Soft synthetic scourers (blue)	YES	YES
Glass scrapers	YES	NO
Liquid polish for domestic appliances and/or glass	YES	YES

Sticky stains that have been burned in can be removed by using a scraper with a razor blade.

Rainbow colouring: Caused by pans that have dry bits of grease on their base or when grease gets between the glass and the pan while cooking. Can be removed from the surface of the glass using a nickel scourer with water or with a special glass ceramic cleaner.

Plastic objects, sugar, or food with a high sugar content that are melted onto the hob should be removed immediately while hot, using a scraper.

When the glass's colour changes.

This does not affect its effectiveness or stability, and is generally caused by inadequate cleaning or by poor-quality pans.

Metallic sheens are caused by metal pans sliding over the glass. They can be removed by thorough cleaning with a special, glass ceramic cleaning agent, although it may be that the cleaning needs to be repeated more than once.

Worn trim is the result of using abrasive cleaning products or pans with uneven bases which wear down the serigraphy.

Please note:

 Take great care when using the glass scraper. The blade can cause

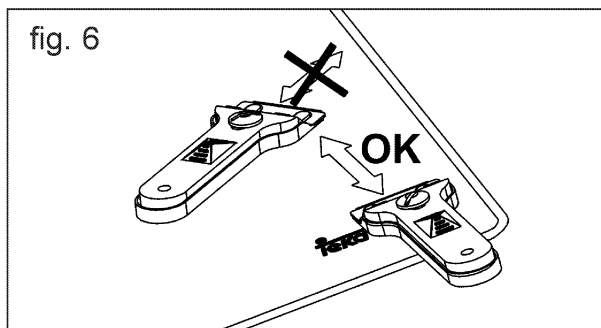

injury!

 If you do not use the scraper properly, the blade could break and pieces may get stuck between the decorative side-piece and the glass. If this happens, do not try to remove the pieces with your hand - use pliers or a sharp-pointed knife. (See fig. 6)

 Only use the blade on the glass ceramic surface - avoid the body of the scraper coming into contact with the glass, since this could scratch the

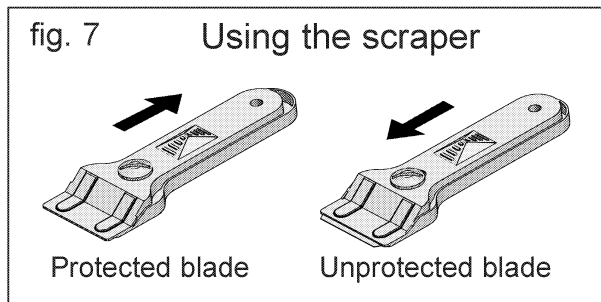

glass ceramic.

 Use blades that are in perfect conditions, and change the blade as soon as it shows any sign of wear.

 When you finish using the scraper, fold it away and cover it well up. (See fig. 7)

 Pans may stick to the glass if something has melted between them. Do not attempt to unstick the pan when it is cold - you could break the glass ceramic.

 TEKA INDUSTRIAL S.A. reserves the right to alter its manuals in any way it deems necessary or useful while not altering their basic characteristics.

Environmental considerations

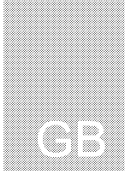

The symbol on the product or on its packaging indicates that this product may not be treated as household waste. Instead it shall be handed over to the applicable collection point for the recycling of electrical and electronic equipment. By ensuring this product is disposed of correctly, you will help prevent potential negative consequences for the environment and human health, which could otherwise be caused by inappropriate waste handling of this product, please contact your local city office, your household waste disposal

service or the shop where you purchased the product.

Packaging materials are organic and fully recyclable. Plastic components are identified by marking >PE<, >LD<, >EPS<, etc. Throw out packaging materials, such as household waste, in the container of your municipality.

If something doesn't work

Before calling the Technical Service, please make the following checks:

Fault	Possible cause	Possible solution
The induction zones are not heating up		
	The pan is unsuitable (it does not have a ferromagnetic base or it is too small).	Check that the pan base reacts to a magnet, or use a larger pan.
When you start using the induction zones, you hear a buzzing sound		
	The pan is light or made up of more than one part. The buzzing comes from energy being transmitted directly to the base of the pan.	This buzzing is not a fault. If, however, you wish to avoid it, lower the power level slightly or use a pan that has a heavier base, and/or that is made of a single part
The touch control does not come on		
	The lock is enabled	Disable the lock.
The sound of a fan can be heard while cooking, and it continues when the cooker has been turned off.		
	There is a fan in the induction zones to cool the electronics.	The fan only comes on when the electronics heat up - when the temperature goes down it goes off automatically, whether or not the hob is on.
When frying or making a stew, the energy in the induction zones seems to decrease ("the hotplate gets less hot")		
	If the temperature of the glass or of the electronics gets too high while cooking, a self-protection system is triggered that adjusts the power of the hotplates so that the temperature does not get any higher.	Overheating problems while cooking only occur under conditions of extreme use (cooking for a long time at full power) or when the hob has been wrongly installed. Check that the hob has been installed as described in the instruction manual.
A plate powers off and message C is displayed on the indicators		
	Excess temperature in the electronics or on the glass.	Wait some time to allow the electronics to cool down or remove the container to allow the glass to cool.

GB

Fault	Possible cause	Possible solution
The hob suddenly starts to bleep		
	There is a cloth, pan or liquid on the Touch Control.	Remove any object covering the Touch Control and/or clean any liquid that might have been spilt on it.
	The timer was activated and the preset time has finished.	Touch the clock sensor to deactivate the bleep.
The hob (or any of the hotplates) powers off during cooking		
	There is a pan, cloth or liquid covering the Touch Control.	Remove any object that might be covering the Touch Control.
	One or several of the hotplates has overheated.	Allow the overheated hotplates to cool down for a few minutes before powering them up again.
A timed hotplate failed to power off at the end of the set time		
	The hotplate had not been set correctly.	Make sure that the time was set following the instructions manual.
After a power outage (or the first time the hob is connected), the control panel remains blocked		
	There is a powerful light affecting the control panel.	Don't apply powerful lights (for example, halogen spotlights) over the control panel when connecting the hob to the electrical current. A very powerful light may cause the sensor buttons not to calibrate correctly after a power outage.