

# TEAC



## SERVICE MANUAL

---

# T-1D

## AM/FM Stereo Tuner

---

### CONTENTS

1 SPECIFICATIONS .....	2
2 ADJUSTMENTS AND CHECKS .....	3
3 EXPLODED VIEWS AND PARTS LIST .....	6
4 PC BOARDS AND PARTS LIST .....	8

### NOTES

- PC boards shown are viewed from parts side.
- The parts with no reference number or no parts number in the exploded views are not supplied.
- As regards the resistors and capacitors, refer to the circuit diagrams contained in this manual.
- ⚠ Parts marked with this sign are safety critical components. They must be replaced with identical components - refer to the appropriate parts list and ensure exact replacement.

# 1 SPECIFICATIONS

## FM Tuner Section

(Without notes 98 MHz, 65 dBf)

**Tuning Range:** 87.5 MHz – 108.0 MHz (50 kHz steps)

**Usable Sensitivity (IHF):**

Mono: 11.2 dBf

**50 dB Quieting Sensitivity:**

Mono: 15 dBf

Stereo: 20 dBf

**Total Harmonic Distortion (1 kHz):**

Mono: 0.4%

Stereo: 0.5%

**Frequency Response:** 30 Hz – 15 kHz, +1/ –1.5 dB

**Stereo Separation (1 kHz):** 40 dB

**Signal-to-Noise Ratio:**

Mono: 72 dB

Stereo: 70 dB

## AM Tuner Section

**Tuning Range:** 522 kHz – 1,620 kHz (9 kHz steps)

**Usable Sensitivity:** 55 dB/m

**Total Harmonic Distortion:** 0.8% at 85 dB/m

**Signal-to-Noise Ratio:** 45 dB at 85 dB/m

## General

**Power Requirements:** 230 V AC, 50 Hz

**Power Consumption:** 8 W

**Dimensions (W x H x D):** 435 x 102 x 270 mm

**Weight (net):** 3.6kg

**Standard Accessories:**

AM Loop Antenna x 1

FM Lead-type Antenna x 1

Power Control Cord x 1

- Improvements may result in specifications and features changing without notice.

# 2 ADJUSTMENTS AND CHECKS

## ■ ALIGNMENT INSTRUCTIONS

### EQUIPMENT NEEDED:

- AM Signal Generator
- FM Signal Generator
- Oscilloscope
- VTVM(AC, DC)
- Test loop antenna (AW Adjustment)
- Dummy antenna (FM Adjustment)
- Stereo signal modulator
- Frequency counter
- Distortion analyser

### IMPORTANT

1. Check power-source voltage.
2. Set the function switch to band aligned.
3. Keep the signal input as low as possible to adjust accurately.
4. Modulation and modulation frequency.

Band \ Item	Modulation	Modulation frequency
AM	30%	400Hz
FM	100%(75KHz Dev.)	400Hz

## ■ ADJUSTMENT POINT

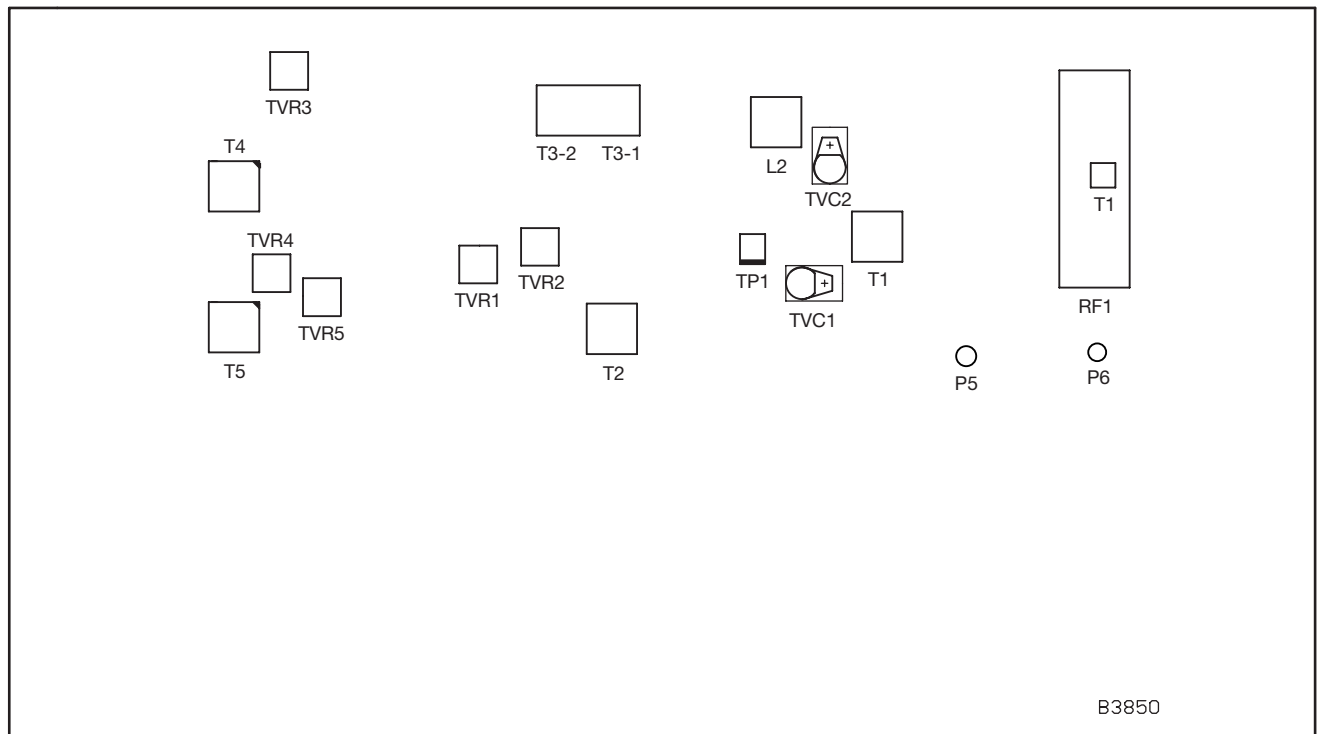

# 1. AM TRACKING VOLTAGE ADJUSTMENTS

DC VOLTMETER..... CONNECT TO TEST POINT P5 and GND

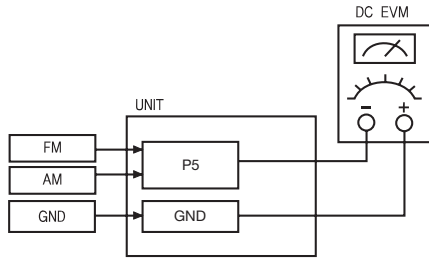

NO.	Band	Frequency	Adjust for	Adjustment
1	AM	603KHz	2.2V	T1
2	AM	1620KHz	9.0V	TVC1

# 2. AM RF ADJUSTMENT

Signal Generator ..... Connects to the AM ANT. Coil through the loop antenna.  
Adjust for the indication of VTVM of the wave form of scope to be maximum.

BAND	Step	Frequency	Adjust for	Adjustment
AM	1	630KHz	Maximum sensitivity	L2, T2
	2	1422KHz	Maximum sensitivity	TVC2
	3	Repeat steps 1 and 2 several times.		

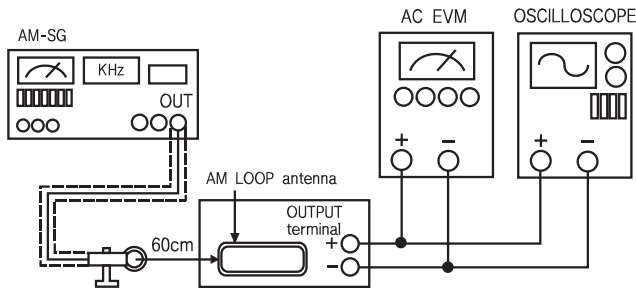

# 3. FM 19kHz REJECTION ADJUSTMENT

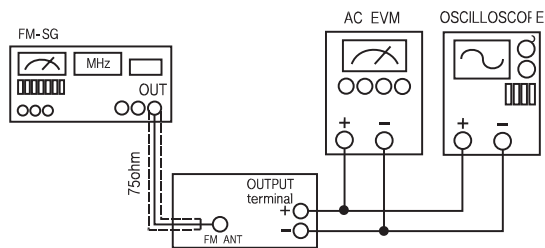

NO.	Frequency	Adjust for	Adjustment
1	97.8MHz	L rejection	T4
2	97.8MHz	R rejection	T5
3	97.8MHz	L, R rejection	TVR3

#### 4. FM MONO DISTORTION ADJUSTMENT

DC VOLT METER .....Connect to TP1(-), TP1(+) Through the choke coil (100 $\mu$ H)  
 Signal Generator .....Connect to FM ANT Jack (FM IN) through the dummy.  
 Distortion Meter .....Connect to the output.

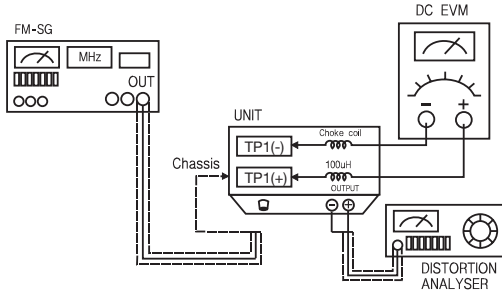

NO.	Frequency	Adjust for	Adjustment
1	97.8MHz	DC Voltmeter 0V	T3-1
2	97.8MHz	Minimum T.H.D	T3-2
3	97.8MHz	Minimum T.H.D	T1
4	Repeat steps 1 and 2 Several times.		

#### 5. FM/AM AUTO STOP LEVEL ADJUSTMENT

FM SIGNAL GENERATOR .....Connect to FM ANT Jack (FM IN) through the dummy  
 AM SIGNAL GENERATOR.....Connect to AM ANT, Coil through the Loop antenna

BAND	STEP	SIGNAL GENERATOR	Adjust for	Adjustment
FM	1	97.8MHz 16dB	<input type="checkbox"/> TUNED Display ON	TVR1
AM	1	630KHz 74dB	<input type="checkbox"/> TUNED Display ON	TVR2

#### 6. FM SEPARATION ADJUSTMENT

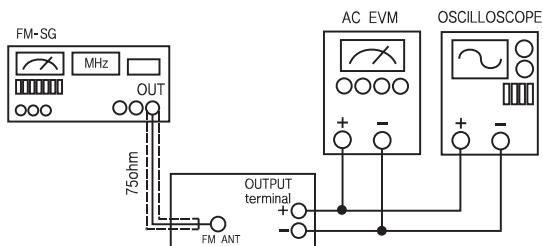

NO.	Frequency	Adjust for	Adjustment
1	97.8MHz	L separation	TVR5
2	97.8MHz	R separation	TVR4

### 3 EXPLODED VIEWS AND PARTS LIST

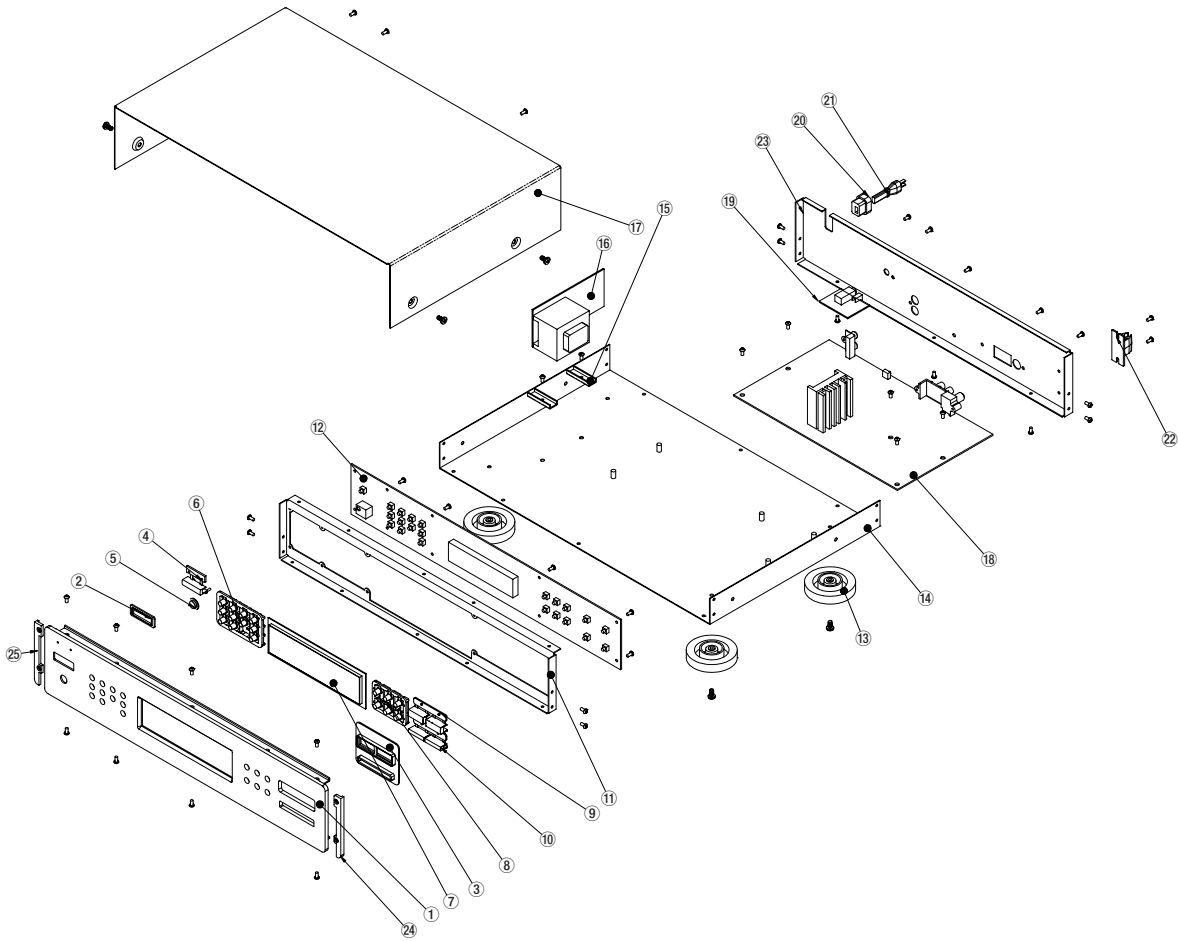

## EXPLODED VIEW LIST

REF. NO.	PARTS NO.	DESCRIPTION	REMARKS
1	9A09523500	FACE PLATE	75L950W0269*
2	9A09503000	WASHER, POWER	85A716*****
3	9A09524400	WASHER	85A717*****
4	9A09523900	KNOB, POWER PUSH	80KB456*****
5	9A09230300	ACRY	85A398*****
6	9A09524000	KNOB, PUSH 11P	80KB457*****
7	9A09230200	ACRY	85A636*****
8	9A09524100	KNOB, PUSH 6P	80KB458*****
9	9A09524200	KNOB, PUSH	80KB459*****
10	9A09524300	KNOB, PUSH	80KB460*****
11	9A09523600	FRONT PLATE	78C287200000
12	9A09525250	KEY PCB ASSY	T1DB4230****
13	9A09503700	FOOT CUSHION	81AD289*****
14	9A09230000	BOTTOM PLATE	78C266200000
15	9A09231700	BRACKER, U-TYPE	78C206000000
16	9A09525150	POWER PCB ASSY	T1DB3852****
17	9A09523800	UPPER COVER	78C287300000
18	9A09525050	TUNER PCB ASSY	T1DB3850****
19	9A09529600	B4231 PCB ASSY	60B4231*****
20	△ 9A09231500	BUSHING, SB4F-4	98BSB4F4****
21	△ 9A09503900	AC CORD	654H2E20B21S
22	9A09231300	HOLDER, ANT	85A271*****
23	9A09523700	REAR PLATE	78C2839W0350
24	9A09502600	END CAP LEFT	76H670000000
25	9A09502700	END CAP RIGHT	76H671000000
F1, F2	△ 9A09231900	FUSE, 0.5A/250V T	265200P521TQ
F3	△ 9A09232000	FUSE, 0.1A/250V T	265200P121TQ

## INCLUDED ACCESSORIES

REF. NO.	PARTS NO.	DESCRIPTION	REMARKS
	9A09146800	OWNER'S MANUAL	9904T1D*****
	9A09525500	FM 75 OHM ANT	64T0005*****
	9A09233800	LOOP ANT	64LA75*****

## 4 PC BOARDS AND PARTS LIST

**B4230/B4231 PCB**

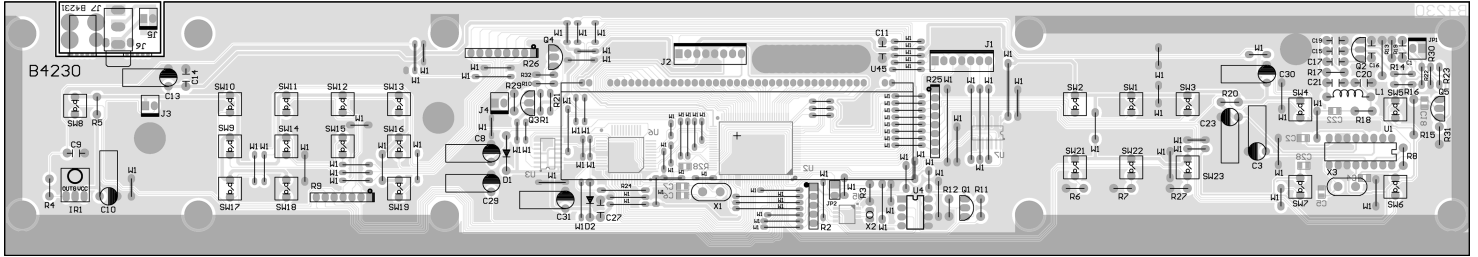

**B3850 PCB**

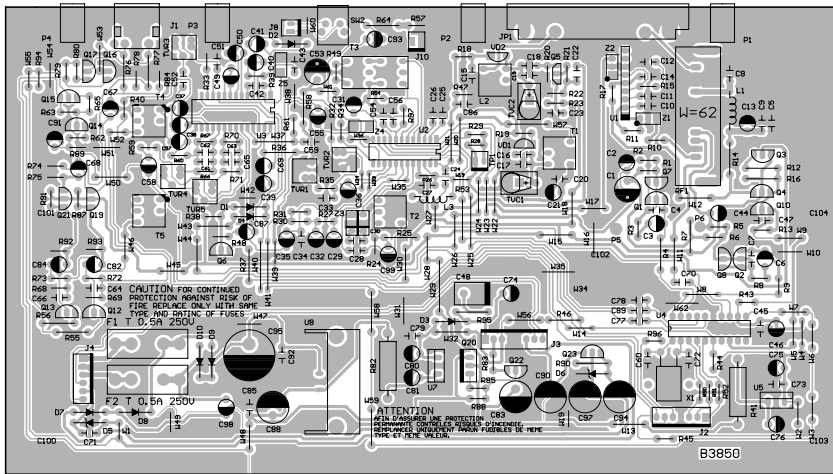

**B3852 PCB**

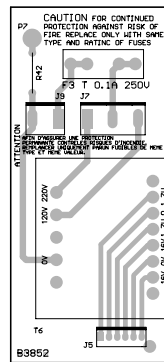



**KEY PCB ASSY**

REF. NO.	PARTS NO.	DESCRIPTION
	9A09525250	KEY PCB ASSY B4230
	9A09529500	KEY PCB B4230
	9A09529300	CONNECTOR, ED-G14 2P
	9A09529400	CONNECTOR, ED-G15 2P
D1, D2	9A09237300	DIODE, 1N4148
IR1	9A09247100	INFERRED RECEIVER, IR-9G
J1 TO J2	9A09247800	CONNECTOR, ED-491 7P
J2 TO J3	9A09247700	CONNECTOR, ED-E67 8P
J3 TO J8	9A09528500	CONNECTOR, ED-F25 2P
Q3	9A09240800	TR, 2SA965
Q4	9A09240500	TR, 2SC1815BL
Q5	9A09511100	TR, 2SC2240
R2	9A09246800	R, NETWORKS 10KX4 5P4R
R9	9A09528600	R, NETWORKS 10KX6 7P6R
R25, R26	9A09246700	R, NETWORKS 10KX7 8P7R
SW1-SW19	9A09247000	TACT SW, SKHVBK3710
SW21-SW23	9A09247000	TACT SW, SKHVBK3710
U1	9A09528800	IC, BU1923
U2	9A09246500	IC, TMP87PM78F
U3	9A09528900	IC, 74HC74DT
U4	9A09246900	IC, 93C66
U6	9A09518900	IC, TMP87CH47U
U7	9A09529000	IC, 74HC04DT
U45	9A09247200	FL TUBE, 25U39167TAN
X1	9A09529100	CRYSTAL, 8MHZ 49US
X3	9A09529200	CRYSTAL, 4.332MHZ 49US

**B4231 PCB ASSY**

REF. NO.	PARTS NO.	DESCRIPTION
	9A09529600	B4231 PCB ASSY
	9A09529500	KEY PCB B4230
J5	9A09244800	WAFER, 5045-2P
J6	9A09529700	PHONE JACK
J7	9A09244600	TERMNAL GND, K-15

**TUNER PCB ASSY**

REF. NO.	PARTS NO.	DESCRIPTION
	9A09525050	TUNER PCB ASSY B3850
	9A09245200	PCB, B3850/B3852/B3853
C95	△ 9A09241800	C, ELEC 2200UF/25V
C97	△ 9A09240000	C, ELEC 100UF/100V
C98	△ 9A09240300	C, ELEC 47UF/63V NP
D1, D2	9A09237300	DIODE, 1N4148
D4	9A09237300	DIODE, 1N4148
D5	9A09237500	ZENER DIODE, 5.6V 0.5W
D6	9A09237600	ZENER DIODE, 22V 0.5W
D7-D10	△ 9A09237400	DIODE, 1N4007
F1, F2	9A09241200	FUSE HOLDER
J1	9A09244500	RCA JACK
J2	9A09245000	WAFER, 5045-7P
J3	9A09525900	WAFER, 5045-8P
J4	9A09244900	WAFER, 5045-6P

**TUNER PCB ASSY**

REF. NO.	PARTS NO.	DESCRIPTION
J8, J10	9A09244800	WAFER, 5045-2P
JP1	9A09526000	ANT TERMINAL
L1	9A09242600	CHOKE, 2.2UH
L2	9A09242800	I. F. T, LA-003
P2	9A09244600	TERMNAL GND
P5, P6	9A09244700	PIN, 1.5x3.5x9
Q1, Q2	9A09240500	TR, 2SC1815BL
Q3	9A09240600	TR, 2SA1015
Q4	9A09240500	TR, 2SC1815BL
Q5	9A09241600	TR, 2SK192A
Q6-Q8	9A09240500	TR, 2SC1815BL
Q10	9A09240500	TR, 2SC1815BL
Q12, Q13	9A09240700	TR, 2SC3327A
Q14	9A09240500	TR, 2SC1815BL
Q15	9A09240600	TR, 2SA1015
Q16, Q17	9A09240700	TR, 2SC3327A
Q19	9A09240500	TR, 2SC1815BL
Q20	9A09242700	TR, 2SB633
Q21, Q22	9A09240500	TR, 2SC1815BL
Q23	△ 9A09240800	TR, 2SA965
R35	9A09241500	NTC THERMISTORS, 300 OHM
R41	△ 9A09527300	R, CARBON 1/2W T 10
R82	△ 9A09527600	R, CARBON 1/2W T 47
R90	△ 9A09241400	R, M. O. F 1W 4K7
RF1	9A09243300	FM TUNER, TFFJ4E570A
SW2	9A09243400	TACT SW, SFKHLU1714
T1	9A09242900	IFT, LO-003
T2	9A09527700	IFT, A-8B C02-8072
T3	9A09243100	IFT, 0203-W009
T4, T5	9A09243200	IFT, 10DF01
TP1	9A09244400	PIN, 2541-2P
TV1, 2	9A09243500	TRIMMER, CTY-112B 8P
TVR1	9A09241000	TVR, 6 H-TYPE 30K
TVR2	9A09240900	TVR, 6 H-TYPE 10K
TVR3	9A09241000	TVR, 6 H-TYPE 30K
TVR4, 5	9A09241100	TVR, 6 H-TYPE 1M
U1	9A09241900	IC, AN278
U2	9A09242000	IC, LA1266
U3	9A09242100	IC, LA3450
U4	9A09242200	IC, TC9257P
U5, U7	△ 9A09242300	IC, AN7805
U8	△ 9A09242400	IC, AN7812
U8	9A09244300	HEAT SINK
VD1, 2	9A09243600	VARI CAP, 1SV149
W37	9A09527800	CHOKE, 15MH
X1	9A09243700	CRYSTAL, 7.2MHZ
Z1	9A09243800	CERAMIC FILTER, SFZ10.7MS2
Z2	9A09243900	CERAMIC FILTER, SFZ10.7MS3
Z3	9A09244000	CERAMIC FILTER, SFZ450B
Z4	9A09244200	CERAMIC FILTER, BFU450CN
Z5	9A09244100	CERAMIC FILTER, CSB456F11

## POWER PCB ASSY

REF. NO.	PARTS NO.	DESCRIPTION
	9A09525150	POWER PCB ASSY B3852
	9A09245200	PCB, B3850/B3852/B3853
	9A09527900	KIT, B3582
F3	9A09241200	FUSE HOLDER
J5 TO J4	9A09245600	CONNECTOR, ED-488 6P
J9	9A09245400	WAFER, 3963-3P2T
T6	△ 9A09245500	TRANSFORMER

# TEAC SCHEMATIC DIAGRAM T-1D

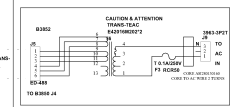
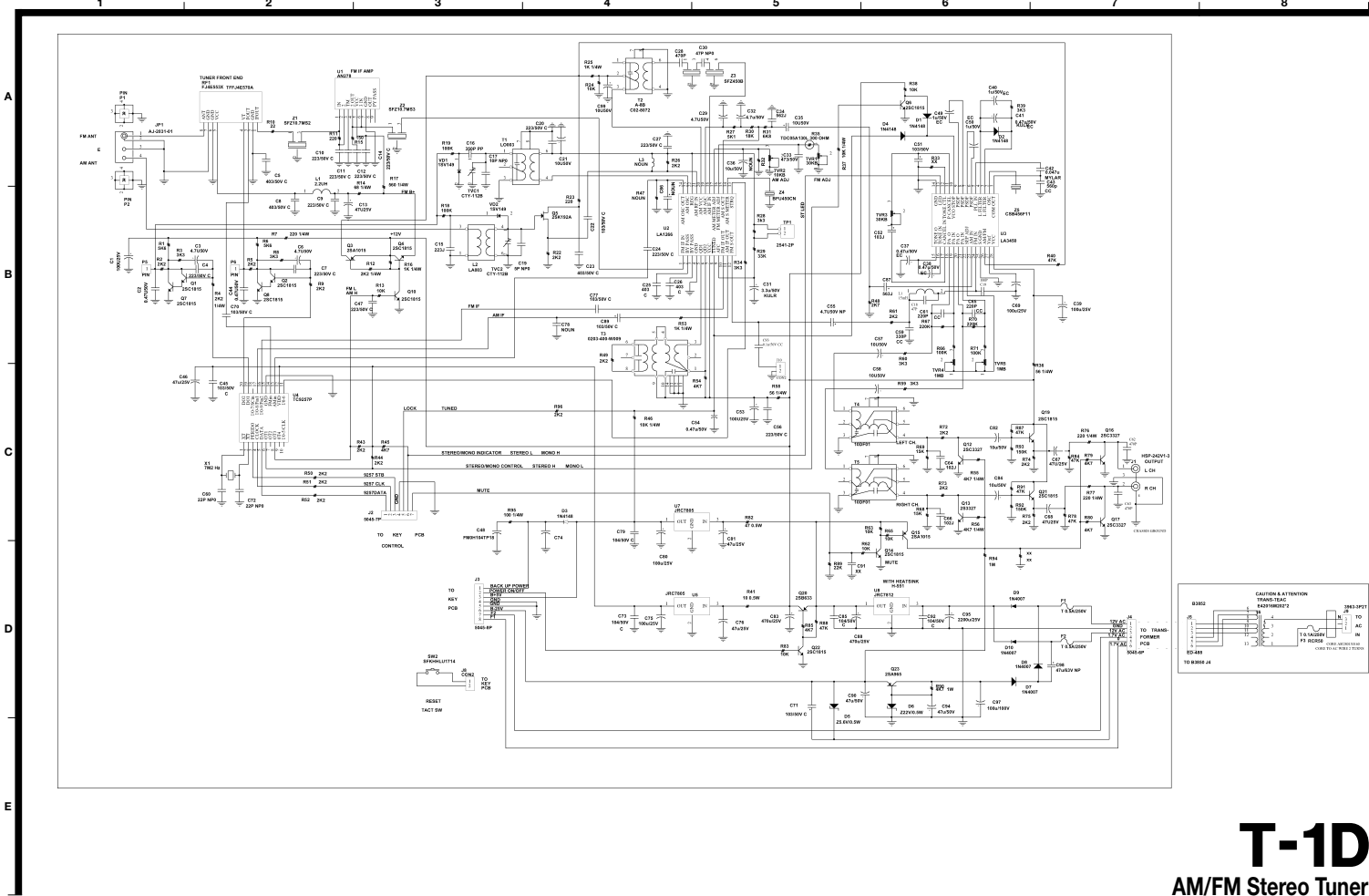

## T-1D

AM/FM Stereo Tuner  
1st Issue; August 2002

**TEAC** SCHEMATIC DIAGRAM **T-1D**

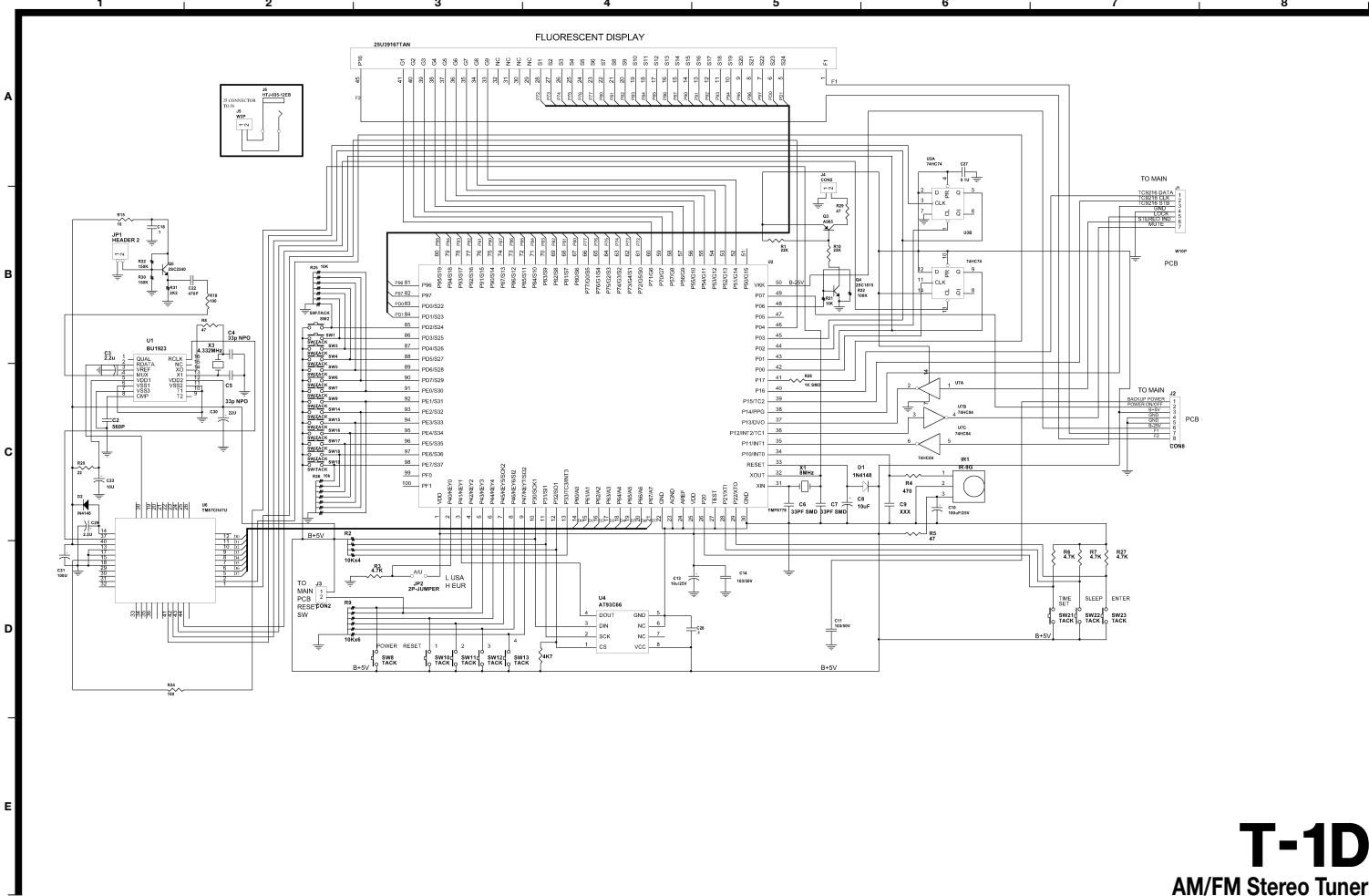

**T-1D**  
 AM/FM Stereo Tuner  
 1st Issue; August 2002