

N7140A0
N7140N0/GB
N7290A0/GB
N7290N0/GB

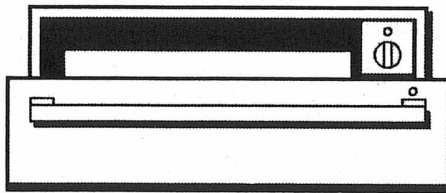

Gebrauchsanweisung
Instruction manual
Mode d'emploi
Istruzioni per l'uso

de	Gebrauchsanweisung	2-14
en	Instruction for use	15-27
fr	Notice d'utilisation	28-40
it	Istruzioni per l'uso	41-56

Table of contents

Important information	16
Before installation	16
Safety information	17
The warming drawer	18
Preheating ovenware	19
Ovenware	19
Method	20
Keeping food warm	21
Method	21
Uses	22
Cleaning and caring for your warming drawer .	23
Warming drawer exterior	23
Heating plate	23
Warming drawer interior	24
Troubleshooting	26
After-sales service	27
Technical data	27

Important information

Read this instruction manual carefully. This will enable you to operate your appliance safely.

Please keep the instruction and installation manual in a safe place. Please pass on the instruction manual to the new owner if you sell the appliance.

Before installation

This appliance is intended only for domestic use.

Please observe the installation manual enclosed.

Transport damage

Check the appliance after unpacking it. Do not connect the appliance if it has been damaged in transport.

Electrical connection

The appliance is fitted with a plug and must only be connected to a properly installed earthed socket. The mains voltage must correspond to the voltage specified on the rating plate.

The sockets must only be installed and the connecting cable replaced by a qualified electrician. If the plug is no longer accessible following installation, an all pin disconnecting device must be present on the installation side with a contact gap of at least 3 mm.

Adapters, multiway strips and extension leads must not be used. Overloading can result in a risk of fire.

Safety information

Use the appliance only for warming meals and ovenware.

Hot surface

The heating plate in the warming drawer becomes very hot. There is a risk of burning. Children must be kept at a safe distance from the appliance. Always use oven gloves or an oven cloth when removing ovenware.

Do not store flammable objects or plastic containers in the warming drawer. Risk of fire.

Cleaning

Do not use a steam jet cleaner to clean the drawer. There is a risk of short-circuiting.

Repairs

Incorrect repairs are dangerous. There is a risk of electrocution.

Repairs may only be carried out by after-sales service technicians.

If the appliance is faulty, remove the fuse from the fuse box or disconnect the appliance at the mains. Call the after-sales service.

Cracks in the glass ceramic

There is a risk of short circuiting if there are fractures or cracks in the glass ceramic.

Switch off the appliance immediately.

Isolate the appliance from the power supply at the fuse box.

Call the after-sales service.

The warming drawer

You can use the warming drawer to preheat dishes or to keep food warm.

“Power on” indicator light

The indicator light flashes when you switch on the appliance. It lights up when the drawer is closed.

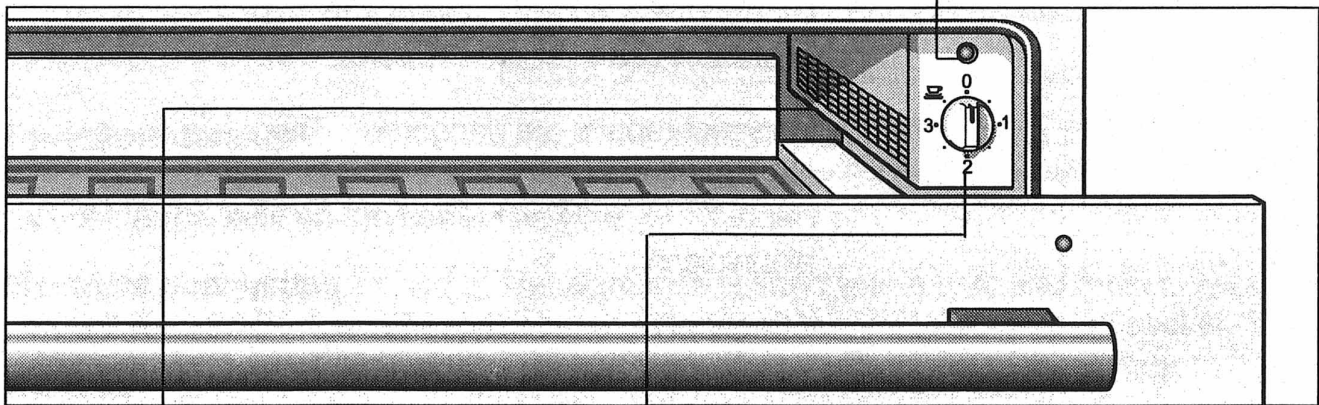

Fan and heater

run when the  preheat dishes setting is selected.

Function selector

The function selector features the following settings

- 0 = Off
- 1 = Allow yeast dough to rise, defrost
- 2 = Keep bread warm, defrost
- 3 = Keep food warm
-  = Preheat dishes

The appliance will only heat up if the drawer is closed correctly.

Preheating ovenware

Food stays warm for longer in preheated ovenware.
Drinks also remain warm for longer.

Ovenware

A load weighing no more than 25 kg should be placed in the warming drawer. You can preheat dinnerware for 6 or 12 people, for example.

low drawer, 14 cm in height		tall drawer, 29 cm in height	
6 dinner plates	Ø 24 cm	12 dinner plates	Ø 24 cm
6 soup bowls	Ø 10 cm	12 soup bowls	Ø 10 cm
1 serving dish	Ø 19 cm	1 serving dish	Ø 22 cm
1 serving dish	Ø 17 cm	1 serving dish	Ø 19 cm
1 meat plate	32 cm	1 serving dish	Ø 17 cm
		2 meat plates	32 cm

Arranging ovenware

As far as possible, distribute the ovenware over the entire surface. It takes longer to warm through tall stacks of plates than individual pieces of ovenware, e.g. 2 serving dishes.

Method

1. Place the ovenware in the drawer.
2. Set the function selector to setting .
The "power on" indicator light flashes.
3. Close the warming drawer.
The "power on" indicator light lights up. The appliance heats up.

How long does preheating take?

The length of time required for preheating depends on the material the ovenware is made of and its thickness, as well as the quantity, height and arrangement of the ovenware.

As far as possible, distribute the ovenware over the entire surface.

It takes approximately 15-25 minutes to preheat dinnerware for 6 people.

Switching off

Open the drawer. Switch off the function selector.

Removing ovenware

Remove ovenware from the drawer using oven gloves or an oven cloth.



The upper surface of the heating plate will be hot.
The base of the ovenware will be hotter than the top.

Keeping food warm

Do not place hot saucepans or pans on the glass surface of the warming drawer immediately after removing them from the hot hob. This could damage the glass surface.

Do not fill the ovenware to such an extent that food spills over.

Cover the food with a heat-resistant lid or aluminium foil.

It is recommended that you do not keep food warm for longer than an hour.

Suitable foods

The appliance is suitable for keeping meat, poultry, fish, sauces, vegetables, side dishes and soups warm.

Method

1. Place the ovenware in the drawer
2. Set the function selector to setting 3 and preheat the appliance for 10 minutes.
3. Add the food to the preheated ovenware.
4. Close the drawer again.
The "power on" indicator light lights up. The appliance heats up.

Switching off

Switch off the function selector.

Remove the food from the drawer using oven gloves or an oven cloth.

Uses

The table shows various uses for the warming drawer.
Set the function selector to the desired setting.
Preheat the dishes as indicated in the table.

Setting	Food	Note
1	Delicate deep-frozen food e.g. cream cakes, butter, sausages, cheese	Defrost
1	Allowing yeast dough to rise	Cover
2	Deep-frozen food e.g. meat, cakes, bread	Defrost
2	Keeping eggs warm e.g. hard-boiled eggs, scrambled eggs	Preheat dishes, cover food
2	Keeping bread warm e.g. toast, bread rolls	Preheat dishes, cover food
3	Keeping food warm	Preheat dishes, cover food
3	Keeping drinks warm	Preheat dishes, cover drink
3	Warming flat dough-based foods e.g. pancakes, wraps, tacos	Preheat dishes, cover food
3	Warming dry cakes e.g. crumble cakes, muffins	Preheat dishes, cover food
3	Melting cooking chocolate or chocolate coating	Preheat dishes, break up food into small pieces
3	Dissolving gelatine	Do not cover, approximately 20 minutes
	Preheating dishes	

Cleaning and caring for your warming drawer

Do not use high-pressure cleaners or steam jets.

Only clean the oven when it is switched off.

Function selector: Setting = 0

Warming drawer exterior

Wipe the appliance with water and a little detergent. Dry it with a soft cloth.

Caustic or abrasive substances are not suitable. If any such substance comes into contact with the front of the warming drawer, wipe it off immediately with water.

Stainless steel surfaces

Always remove any flecks of limescale, grease, cornflour or egg white immediately. Corrosion can form under such flecks.

For cleaning, use water with a little detergent. Dry the surface with a soft cloth.

Appliances with an aluminium front

Use a mild window-cleaning detergent and a soft window cloth or a fluff-free micro-fibre cloth. Wipe the surface using a horizontal motion and do not apply pressure.

Do not use aggressive cleaning products, abrasive sponges or harsh cleaning cloths.

Heating plate

Clean the heating plate using water and a little detergent.

Warming drawer interior

Removal

The drawer can be removed if the appliance requires cleaning on the inside.

1. Remove the drawer completely.
2. Undo the two rear screws.
Loosen the two front screws halfway.
3. Take hold of the front of the drawer on both sides.
The rear section of the guide rails has been lubricated.
4. Carefully remove the drawer in an upwards direction and set it down.

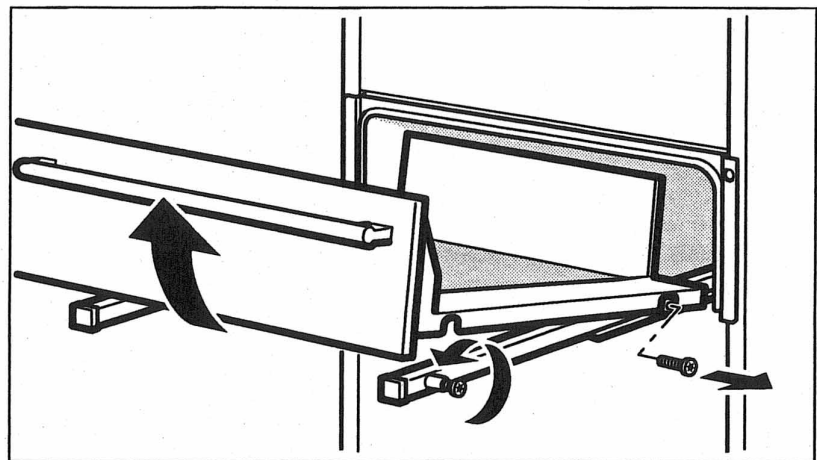

The appliance can now be cleaned on the inside with water and detergent.



Do not immerse the drawer in water once it has been removed.

Installation

Proceed in the reverse order of removal to refit the warming drawer.

To do this, position the drawer on the rails. Pull the left and right rails forward until the screws sit in the recess.

Tighten the screws.

Please bear the following in mind:

There is a tensioning hook under the warming drawer on both the left-hand and right-hand sides.

The drawer can only be opened if the tensioning hook is in the correct position.

If a hook has slipped out of the guide rail (illustration B), you will need to force it backwards until it snaps into position (illustration A).

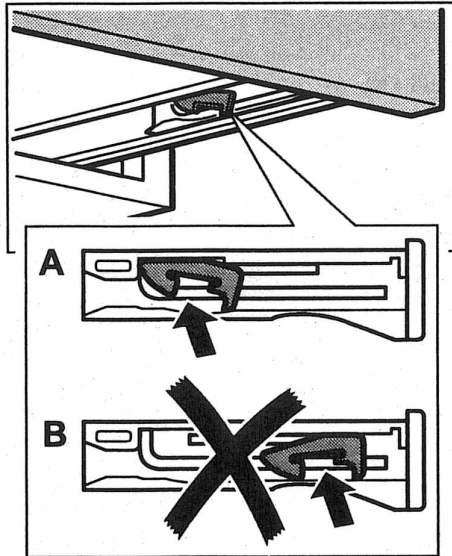

Troubleshooting

Malfunctions often have simple explanations. Please read the following instructions before calling the after-sales service:

The ovenware or food remain cold

Check whether

- the appliance is switched on
- there has been a power cut
- the drawer is closed completely.

The ovenware or food are not warmed sufficiently

This may indicate that

- the ovenware or food were not warmed for a sufficient length of time
- the drawer was left open for a long time.

The "power on" indicator light flashes

Check whether the drawer is closed. If it cannot be closed, check the position of the tensioning hooks as described under "Installation" in the "Cleaning and caring for your warming drawer" section.

The drawer does not close properly

Check the position of the tensioning hooks as described under "Installation" in the "Cleaning and caring for your warming drawer" section.

The indicator light flashes rapidly when the warming drawer is closed

Call the after-sales service

The "power on" indicator light does not light up

The indicator light is faulty.
Consult the after-sales service

The fuse in the fuse box has blown

Disconnect the appliance at the mains and consult the after-sales service.

Repairs must only be carried out by qualified specialists. Incorrect repairs may result in serious injury to the user.