

User Manual of 2nd Generation Grid Tie Inverter with Limiter

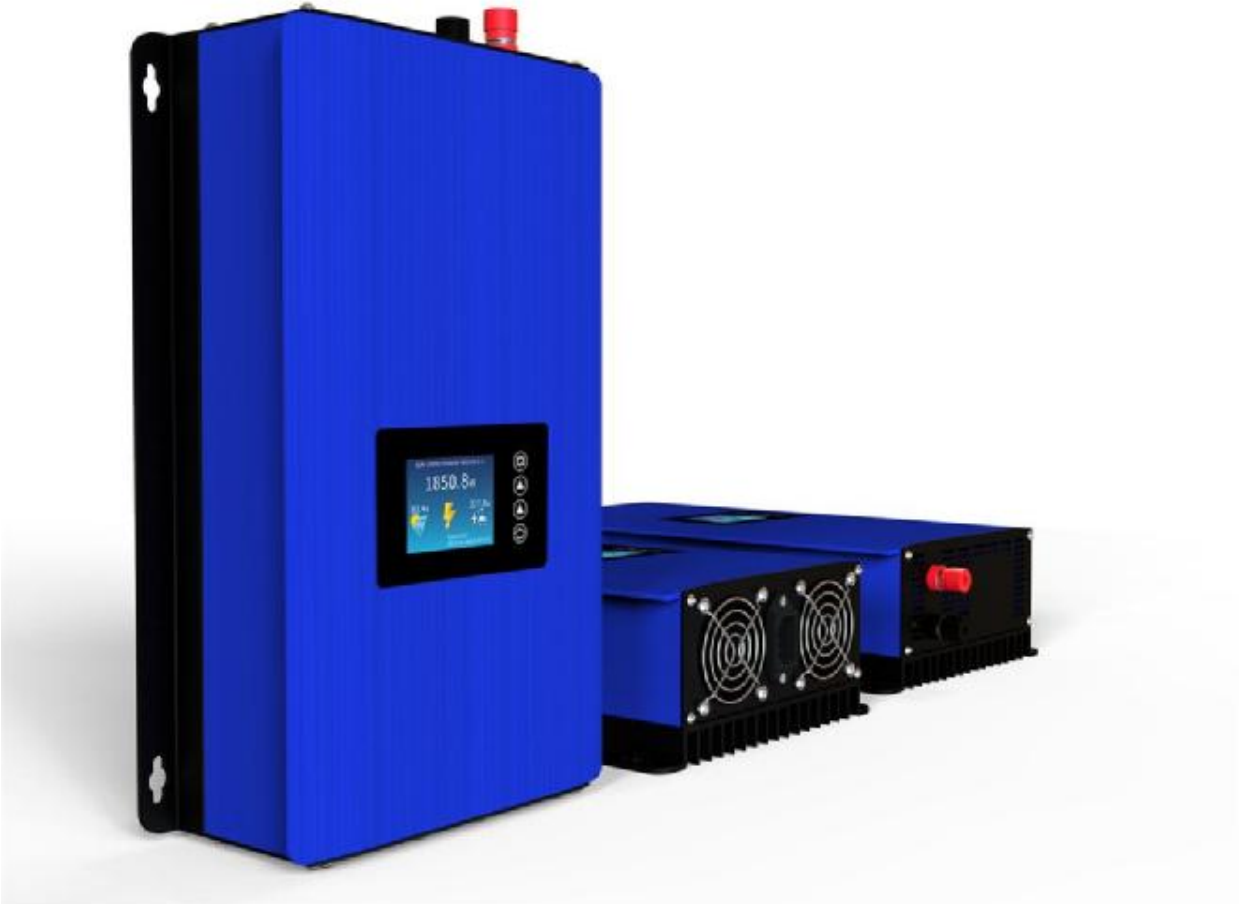

Grid Tie Inverter With Internal&External Limiter (GTIL)

2016-3-1 All rights reserved

Why we produced the GTI-L --- It is in response to the overwhelming clamor from our customers for a product that can control the amount of power that the grid tie inverters (GTI) can generate so that the amount of excess power produced by the solar panels are reduced to insignificant levels, if not eliminated --- because in some countries, the producer pays for the excess power it gives to the distribution grid. This is because the electric power meters (the one provided by the electricity provider in the area) are not aware of the direction of power flow. In other words it only adds even if power is exported to the grid, thus, the consumers will be charged for power even if it is given to the grid, and this is the problem

This is the 2nd generation GTIL of Masspower. The first generation GTIL must be used with an additional limiter module, we also add a switch button to enable the inverter either can work at limit mode or at normal grid tie mode. With the 2nd generation GTIL, we integrated the limit function inside the GTI. We call this internal limiter. In this way, no additional limiter module is needed, reduced customer's cost, more easier for installation. But in case customer install inverter far away from the main circuit breaker, we also enable the 2nd GTIL work with stand-alone limiter, we call this-external limiter. For sure, the inverter can work under normal Grid tie-no limit mode, just set on the nice LCD and save your setting.

1. On-Grid System Using Standard Grid Tie Inverter

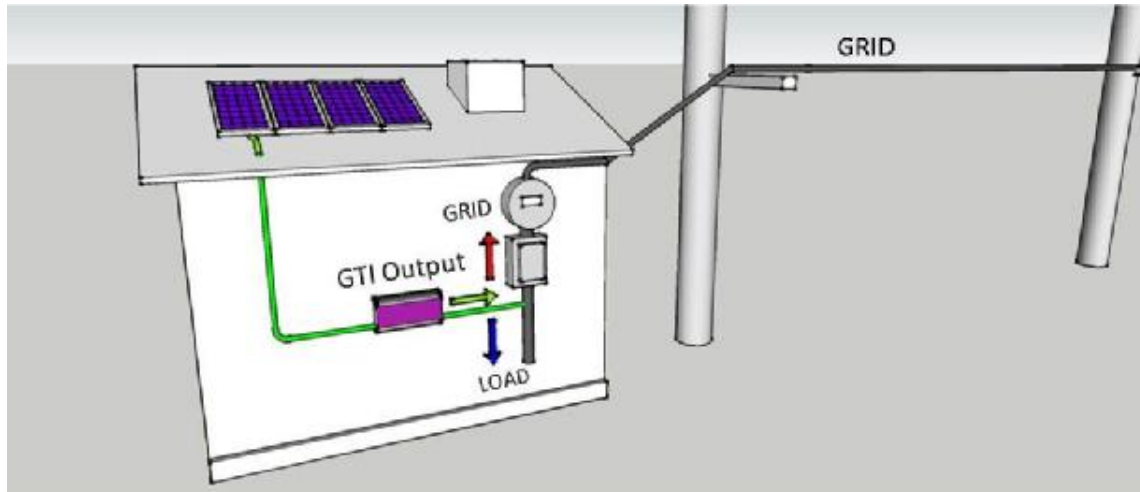

- 1.1. The Grid Tie inverter converts DC power produced by Solar Panels to AC, connects to the grid and feed all of the power available from the panels to the AC load.
- 1.2. All excess power that is not needed by the load is then exported to the Grid.
- 1.3. If the Grid fails, then the Grid Tie Inverter will turn off. When the Grid comes back on line. The Grid Tie Inverter will again supply power to the load and any excess power is exported to the Grid again.
- 1.4. If the Solar Panel is producing less power and the GTI cannot deliver all the power needed by the load, then power will be supplemented by the Grid.
- 1.5. Power Meters (Except smart meter) are not aware of the direction of Power flow. The user then pays for the power exported and delivered by the Grid.

2. On-Grid System Using Grid Tie Inverter With Limiter (GTIL)

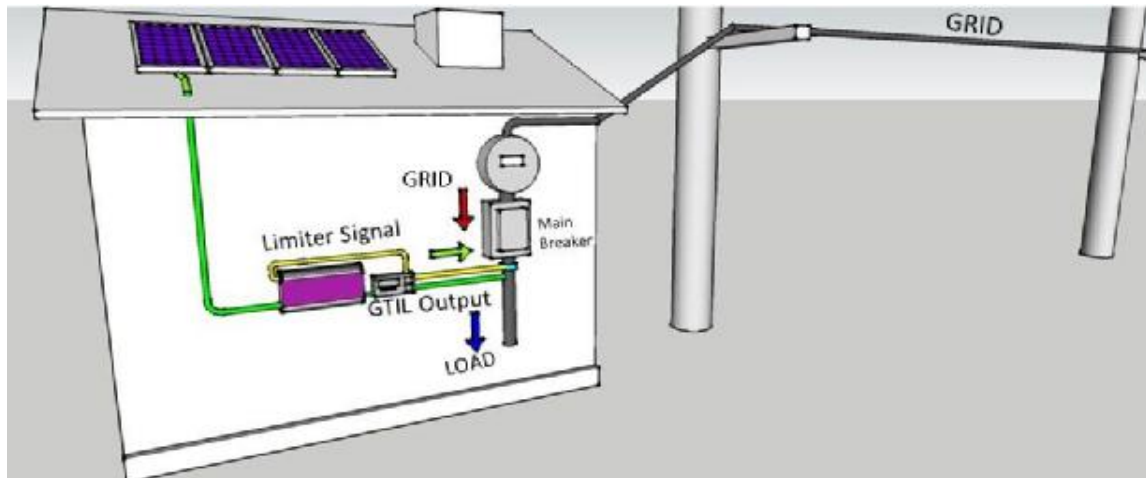

- 2.1 The Grid Tie Inverter with Limiter delivers only the power needed by the load and prevents delivering excess power hence avoids excess power in going back to the Grid.
- 2.2 The heart of the Grid Tie Inverter with Limiter is the Limiter Module (LM). The LM continuously sampled the power needed by the load through the current sensor connected after the Main Circuit Breaker. The LM then will process the signal. It then sends signal to Grid Tie Inverter how much power to deliver to the load in real time.
- 2.3 The user, after installing and connecting the GTIL correctly, need not do anything and the unit will do its work automatically.

3. The Limiter Module-Parts Description

GTIL LIMITER MODULE

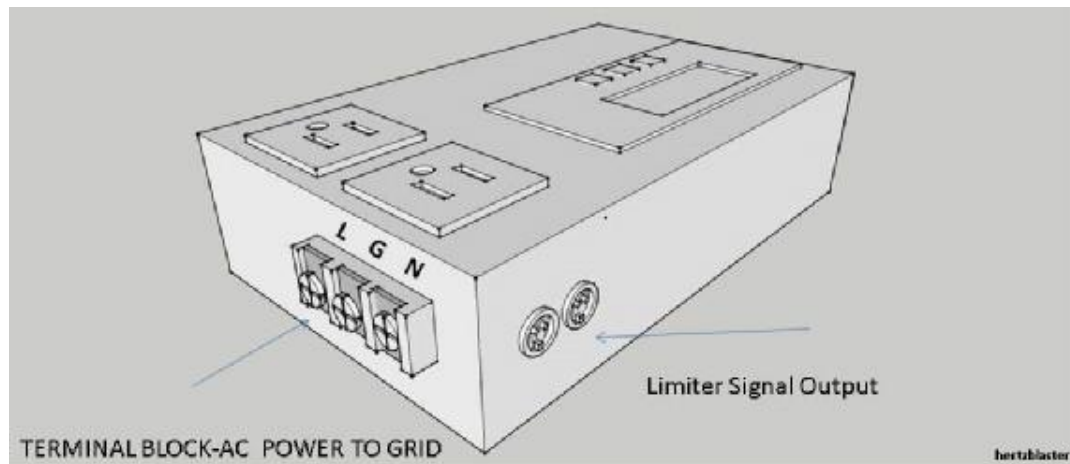
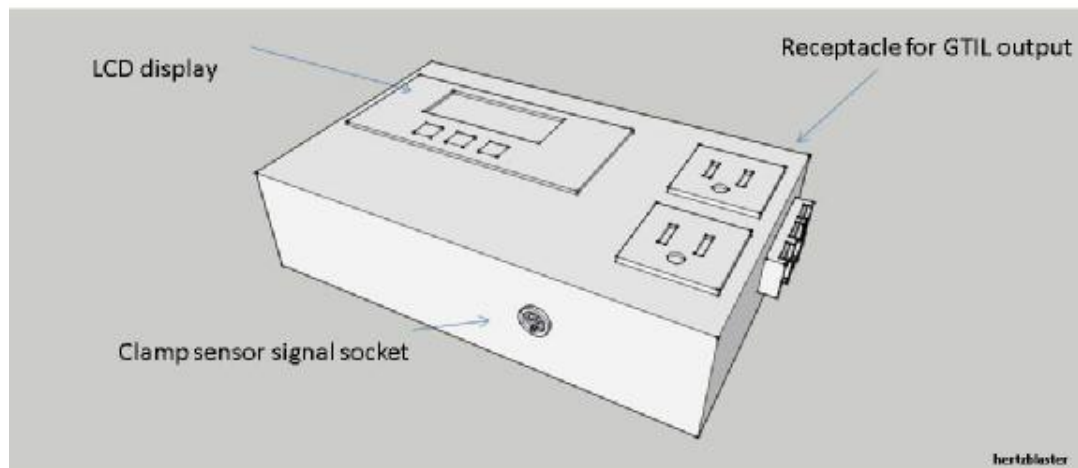

3.1. The LCD Display

Displays the Utility Power (grid power), Inverter Power (GTIL power), Utility KWH and Inverter KWH.

3.2. AC Receptacle For GTIL AC output

Two (2 pcs) - Connects the AC output of GTIL to LM. Can be plug in either receptacle. Maximum Power per receptacle is 2kw or a total of 4kw GTIL can be plugged in the two receptacles. The output of GTIL can also be directly connected to the grid or through the house convenient outlet. But the LCD will not display the Inverter Power.

3.3. Clamp Sensor

Connects/clamps to one hot wire after the Main Circuit Breaker. Converts the magnetic field created by the flow of current in the wire into small AC voltage and current which is proportional to the power that passes through the wire.

3.4. Clamp sensor AC signal socket– connects the clamp sensor AC signal to the LM module.

3.5. Terminal Block- AC power to Grid

The AC output of the GTIL is plugged to the LM receptacle in order for the LCD to display the GTIL output in watts and KWH. The GTIL output is connected to the Grid through the Terminal Block. Connecting the terminal block to AC grid also powers the wattmeter and limiter circuit.

3.6. Limiter DC Signal Output, 2 pcs– Connects the LM output signal to the GTIL signal input. User can connect to any of the signal output receptacle.

4. WIRING DIAGRAM WITH EXTERNAL LIMITER

**CONNECTION DIAGRAM 2- GTIL REMOTELY LOCATED
(External Limiter Required)**

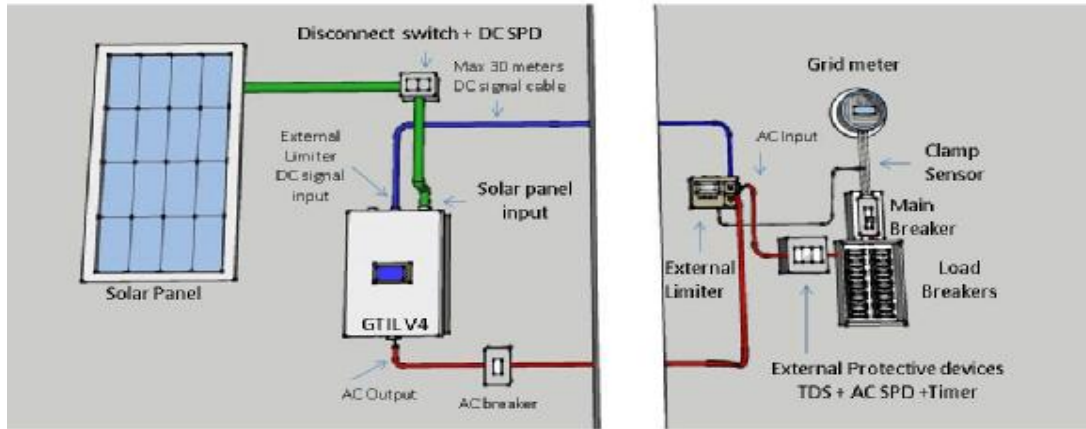

**CONNECTION DIAGRAM- GTIL REMOTELY LOCATED
(External Limiter Required)**

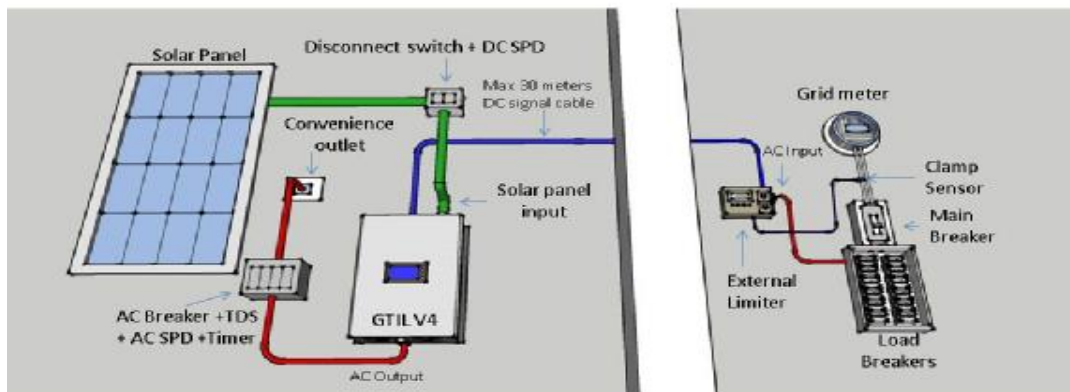

4.1. The installations of the GTIL system are shown above, The ac plug can either connect to the nearby AC socket or plug into the limiter socket, the dc signal cable can reach max 30 meters length so that you can able to install the inverter far away from the limiter module. The ideal installation is that the limiter install near the GTIL. The GTIL unit and the Limiter Module are placed close to each other. The signal wires will be short, as supplied with the unit.

4.2. Use a dedicated 20 A breaker for the GTIL in the Load Circuit breaker panel board

4.3. Wiring and Connection Procedure

4.3.1. After the GTIL and LM are properly installed. Shut off the main circuit breaker. Connect the clamp sensor to one hot wire after the main breaker. Connect the other end of clamp sensor signal cable to the LM. Neatly lay out the signal cable. You can now safely open the Main breaker.

Step 1 – Connecting the AC clamp sensor

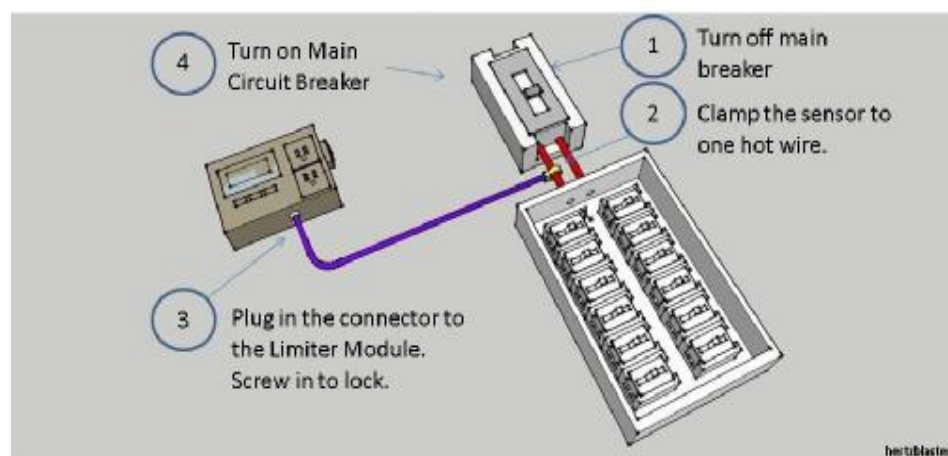

4.3.2 Connect the LM module to grid. Using the terminal block, use at least wire no.12 AWG (20A ampacity - wire not included in the package) and connect to 20A circuit

breaker dedicated for the GTIL. **Make sure the 20A breaker is off while wiring. Do not turn on the breaker!**

Step 2-Connecting Limiter Module to Grid

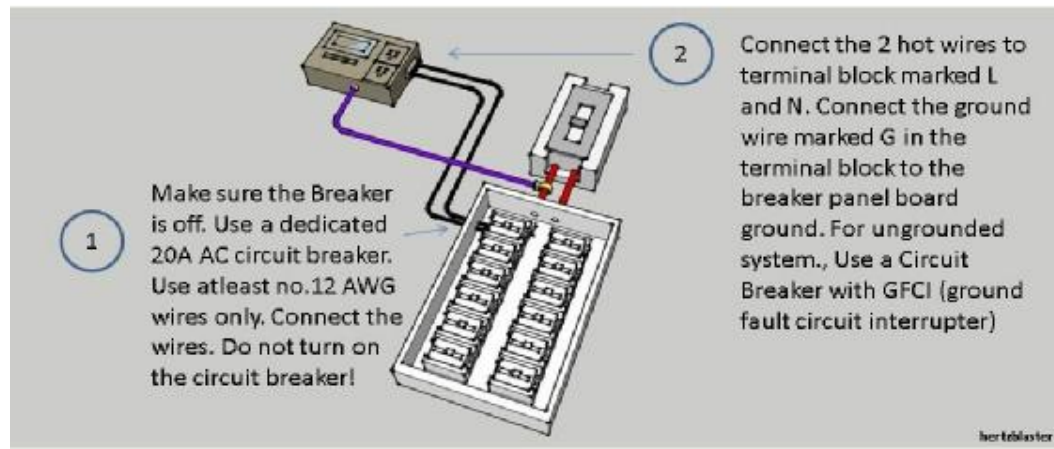

4.3.3 Connect the DC signal cable from LM to GTIL input. The connectors have threaded screw to securely fasten the connectors plug at both ends of the cable. Also the connector plugs have dent/slot in the plugs body so it can only be connected in one direction or position.

Step 3-Connecting Limiter module DC output signal to GTIL

Using the dc signal cable which provided by supplier to connect the external limiter connector of the GTIL to the limiter DC connector.DC output signal socket in the limiter module is marked A and B,you can connect the connector of the cable to either A or B.Plug in and screw in to lock.

Step4-Connect the solar panel cable to the GTIL DC input

4.3.5. Connect the Solar panel output to the DC power input of GTIL. Make sure the disconnect switch/breaker of solar panel is off.

Before connecting the solar panel cable, make sure that the solar panel disconnect switch or DC breaker is off and observe correct polarity when connecting the cable. Failure to follow will cause serious problem with the unit. Please read the manual booklet of the GTI included in the package for correct wire and circuit breaker/disconnect switch rating. Do not turn on the DC circuit breaker/disconnect switch.

4.3.6. Review all connections and make sure of the tightness of plugs and connections. Re-check DC polarity connections of solar panel.

4.3.7. Turn on the 20A circuit breaker to power the Limiter Module.

4.3.8. In the LM, Press SET button below the LCD for a few seconds. The LCD will light up and initialize.

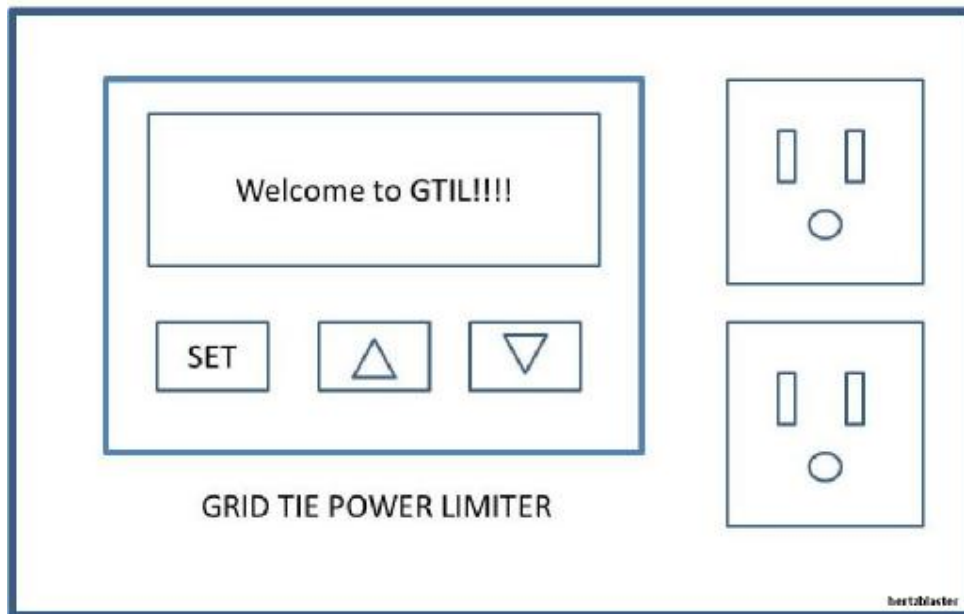

4.3.8. After initialization, LCD will display Utility Power, which is the actual power or total load in real time. Press the up and down buttons to display the Inverter Power, Utility power, Utility Total KWH and Inverter Total KWH. Inverter Power should read zero initially.

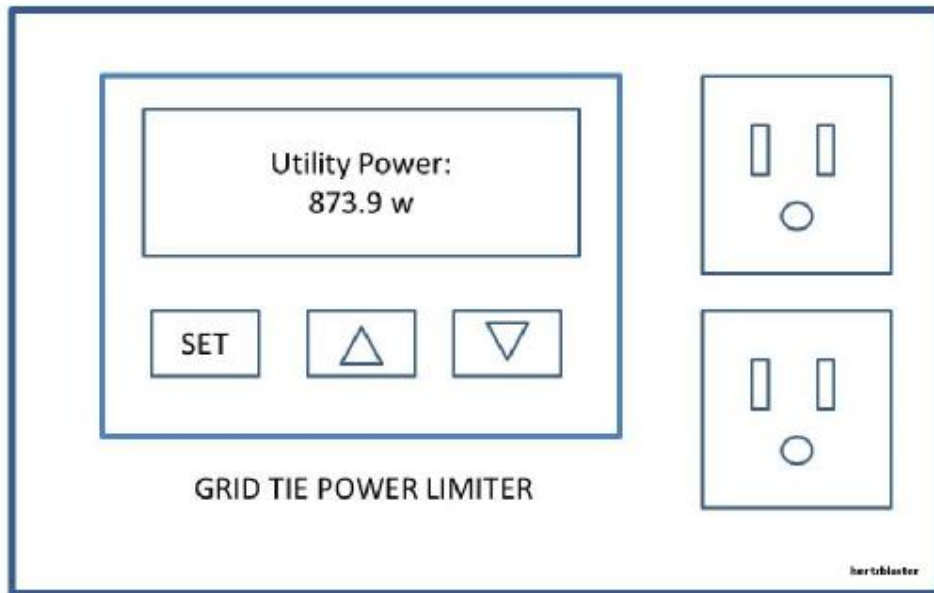

To reset the Utility Total, just press the up button for a few seconds and you will be prompted yes or no to reset. Press up or down button to select either yes or no, and then press SET to reset .

To reset Inverter Total, press the down button continuously and you will be prompted yes or no also to reset. Press up or down to select yes or no and Press SET to reset.

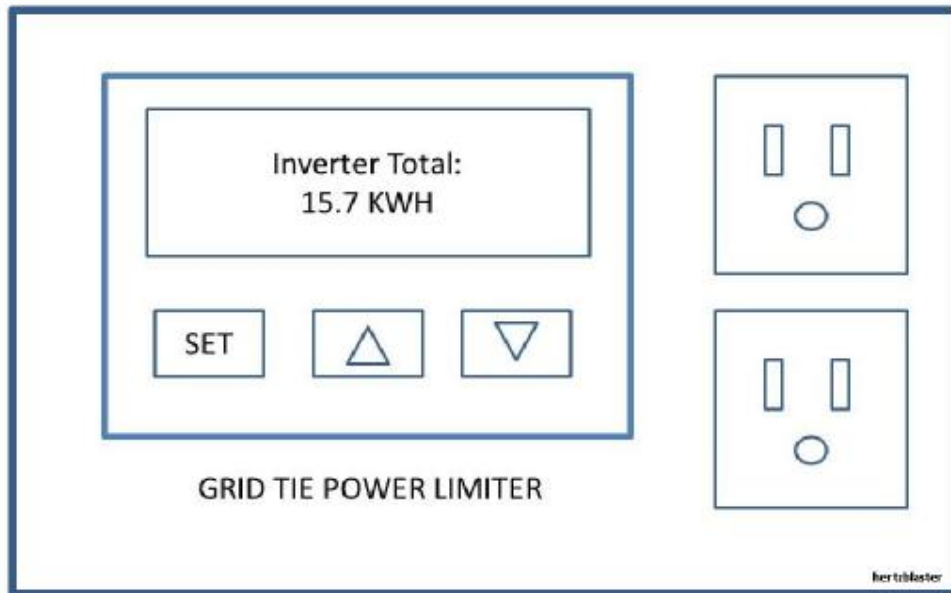

4.3.9. Connect the GTIL power output to the LM AC receptacle using the supplied cable. Turn on the disconnect switch/dc breaker of solar panel.

The wattmeter in the GTIL should power up and start producing power after a minute or two.

4.3.10 Check the LM display. The utility power should display 0-15w indicating the GTIL is already supplying power to the load. Check the inverter power display in the LCD.

4.3.11 To shutdown, turn-off or unplug first the GTIL before disconnecting the power to limiter module. Or shut off the breaker to LM module to cut power to whole set-up. Do not disconnect Solar panel connection to GTIL while the system is operating.

4.3.12 In normal operation, when the unit is started or the LM breaker is turned on, while all the cables are connected and DC breaker is on, there will be about 2 minutes and 20seconds time delay before the GTIL unit will run. Always

remember that for LM module to power-up, need to press Set buttons first in the LM module for the system to run.

5. Installation of GTIL With Internal Limiter

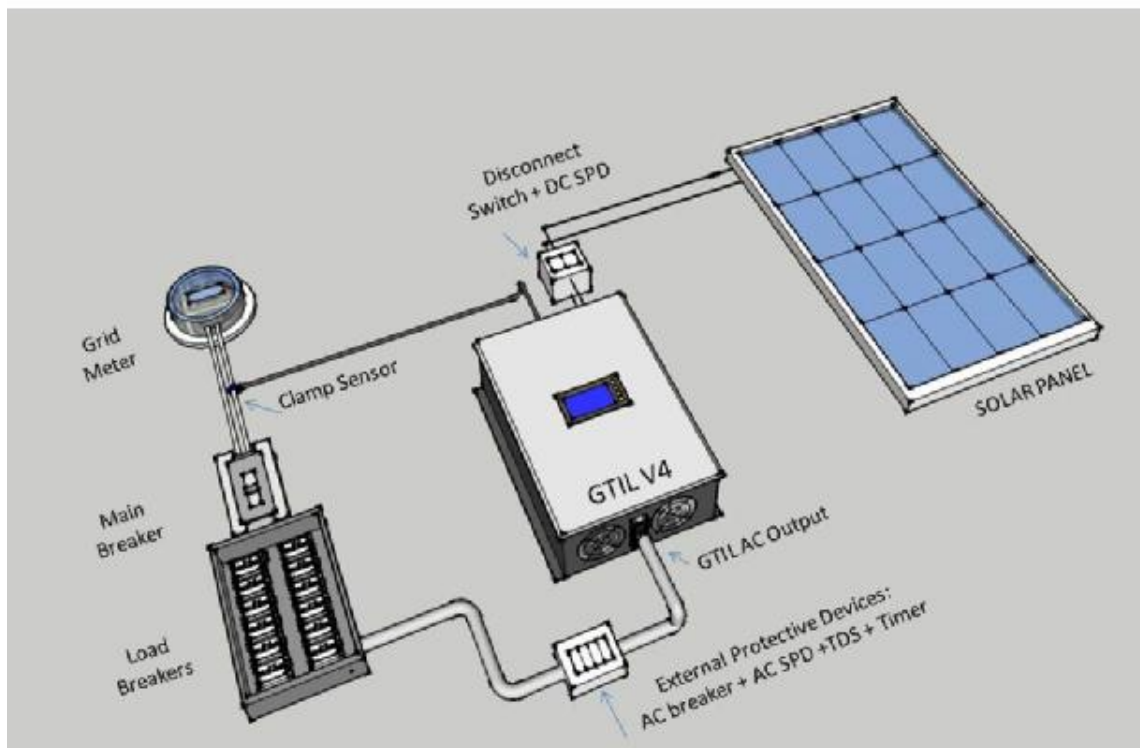

- 5.1. This installation is not require an additional limiter module,Installation is much easier.Clamp the current sensor cable to the hot wire to measure the current,the internal limiter will auto detect the load power and control the inverter output power,excess power will be well controlled.
- 5.2. External protective device including dc and ac SPD(Surge protection device),dc and ac breaker,etc is recommended to installed in the system.

Limiter Setting on the LCD of the inverter:

The GTIL include three working mode: Work as normal GTI without power limitation. Work under Internal limiter mode and Work under External limiter mode, Pls make your setting on the LCD and save it, details setting operation, pls read the GTI manual.

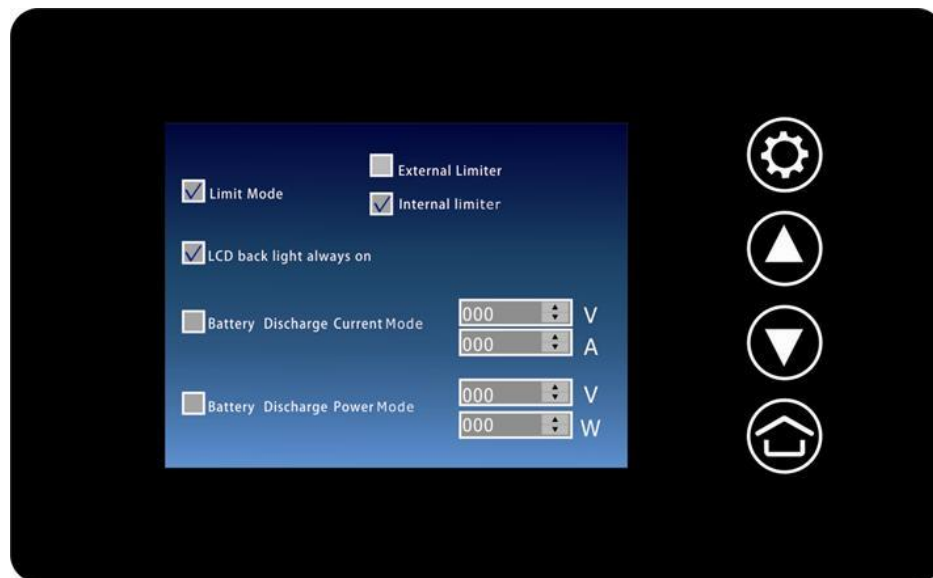

The connector of Internal&External Limiter:



Attention:For external limiter mode.Need to long press the SET button when initial power on the GTIL system after all connections are done.Due to grid failure or malfunction,GTIL system will able to auto restart after grid recover.

After sales service and technical support- For more information about installation and other concerns, or if you have more questions or clarification about the product.

6.0 Limiter Module Specification

1. Clamp sensor- Max 100A
2. Wattmeter- Max 9999w
3. Terminal Block-Max 20A
4. Receptacle- max 2000w
5. Clamp sensor signal- 5v AC max mA
6. DC signal Cable- 5v DC, _____ max mA

Available Masspower GTIL Model

1000W -Model SUN-1000GTIL2-LCD

22-60VDC/45-90VDC,120VAC/230VAC

2000W- Model SUN-2000GTIL2-LCD

45-90VDC/230VAC