

Installation Instructions

PHM3 SERIES

PACKAGE HEAT PUMPS

TABLE OF CONTENTS

SAFETY LABELING AND SIGNAL WORDS	2	CONTROL BOX CONFIGURATION AND WIRING	7
UNIT DIMENSIONS	3	WIRING DIAGRAMS	8
SAFE INSTALLATION REQUIREMENTS	3	RAIN SHIELD INSTALLATION	10
LOCATING THE UNIT	3	AIR DISTRIBUTION SYSTEM	10
CLEARANCES	4	DUCTWORK	10
INSTALLATION	4	FILTERS	10
INSTALLING DUCT COLLARS	4	UNIT ELECTRICAL WIRING	10
CONDENSATE DRAIN	5	START-UP PROCEDURES	11
UNIT ELECTRICAL WIRING	5	SPEED TAPS	11
LINE VOLTAGE	5	CHECK BEFORE STARTING	11
CONVERTING 230V TO 208V	6	DEFROST INTERVAL	12
LOW VOLTAGE WIRING	6	SEQUENCE OF OPERATION	13
THERMOSTAT CONNECTIONS	6	OPERATION	14
FINAL ELECTRICAL CHECK	6		



1. Safety Labeling and Signal Words

Danger, Warning and Caution

The signal words **DANGER**, **WARNING** and **CAUTION** are used to identify levels of hazard seriousness. The signal word **DANGER** is only used on product labels to signify an immediate hazard. The signal words **WARNING** and **CAUTION** will be used on product labels and throughout this manual and other manuals that may apply to the product.

Signal Words

DANGER - Immediate hazards which **WILL** result in severe personal injury or death.

WARNING - Hazards or unsafe practices which **COULD** result in severe personal injury or death.

CAUTION - Hazards or unsafe practices which **MAY** result in minor personal injury or product or property damage.

Signal Words in Manuals

The signal word **WARNING** is used throughout this manual in the following manner:

WARNING

The signal word **CAUTION** is used throughout this manual in the following manner:

CAUTION

Product Labeling

Signal words are used in combination with colors and/or pictures on product labels. Following are examples of product labels with explanations of the colors used.

Danger Label

White lettering on a black background except the word **DANGER** which is white with a red background.

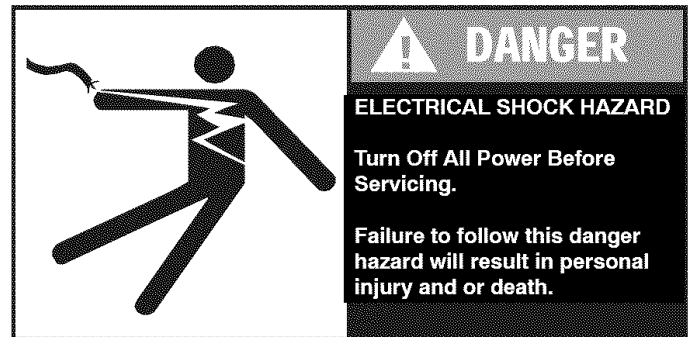

Warning Label

White lettering on a black background except the word **WARNING** which is black with an orange background.

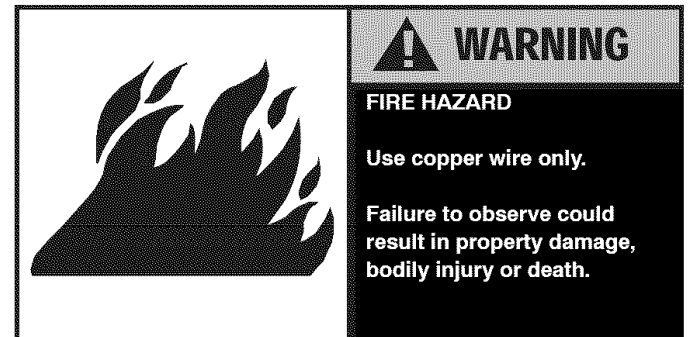

Caution Label

White lettering on a black background except the word **CAUTION** which is black with a yellow background.

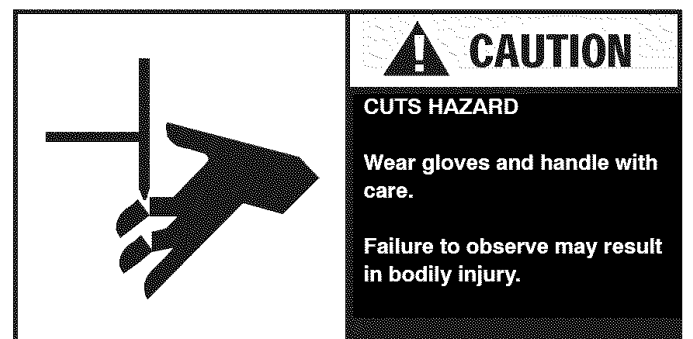

2. Dimensions

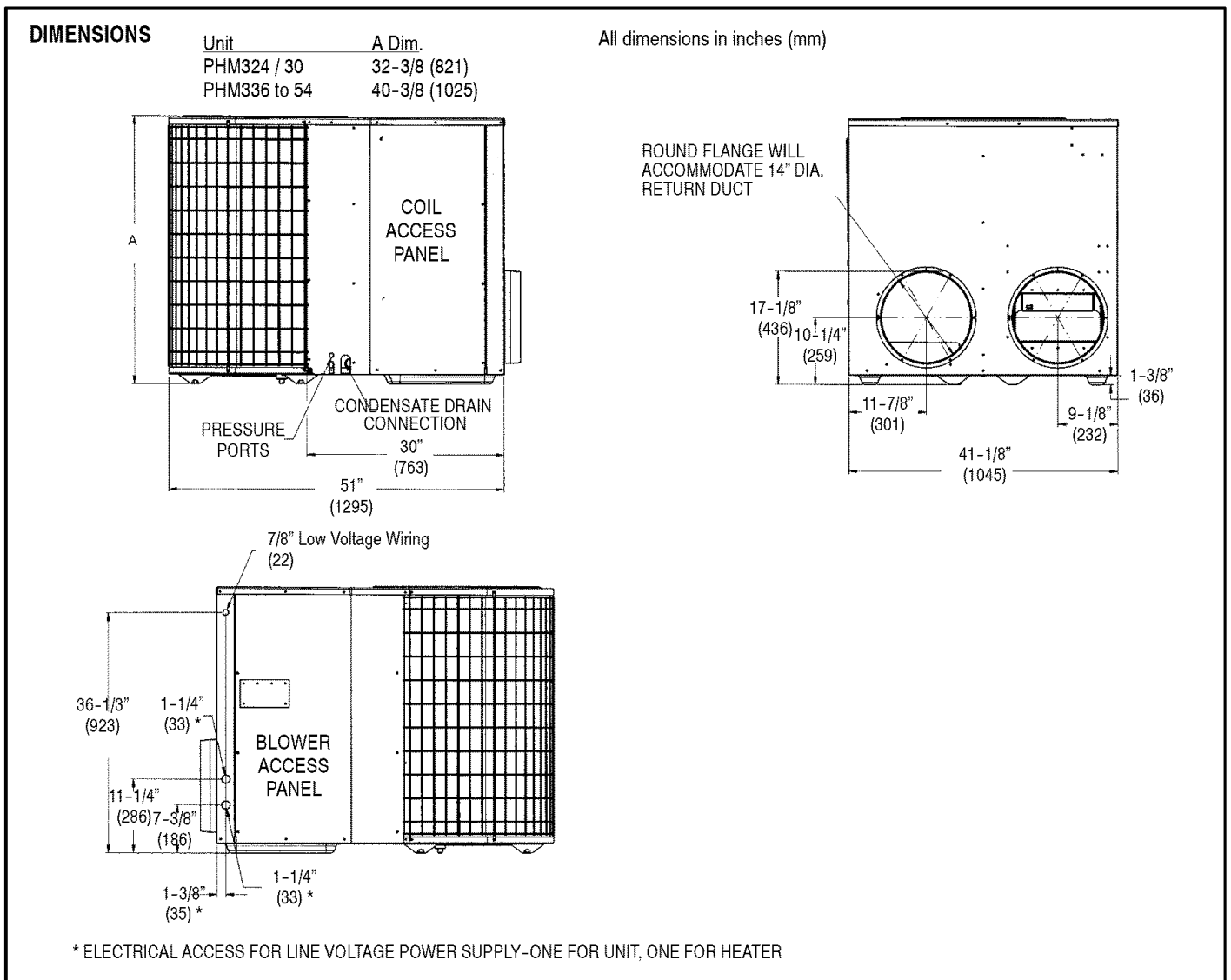

3. Safe Installation Requirements

⚠ WARNING

FIRE, EXPLOSION, ELECTRICAL SHOCK HAZARD

Installation or repairs made by unqualified persons can result in hazards to you and others. Installation **MUST** conform with local building codes or, in the absence of local codes, with the ANSI Z223.1 and the National Electrical Code NFPA70-current edition or in Canada the National Standard CAN/CGA B149-1 and CSA C.22.1 - Canadian Electrical Code Part 1.

Failure to carefully read and follow all instructions in this manual could result in furnace malfunction, property damage, personal injury and/or death.

The information contained in this manual is intended for use by a qualified service technician familiar with safety procedures and equipped with the proper tools and test instruments.

- Seal supply and return air ducts.

- Check to see that filters are installed correctly and are the proper type and size.

NOTE: It is the personal responsibility and obligation of the customer to contact a qualified installer to ensure that the installation is adequate and conforms to governing codes and ordinances.



CAUTION

REDUCED UNIT LIFE HAZARD

Failure to follow this caution may result in property damage

Do **NOT** operate unit in a corrosive atmosphere containing chlorine, fluorine, or any other corrosive chemicals.

4. Locating The Unit

The unit is designed for outdoor installation only. Place the unit on a platform at ground level. The unit may be installed on a concrete slab of 48" (1219mm) x 48" (1219mm) dimensions. Concrete blocks on a 3" sand footing will also work. The slab or blocks

SHOULD NOT be in contact with any part of the structure. Check local codes covering zoning, noise, platforms, etc..

Avoid locating next to fresh air intakes, vent or bedroom windows. Noise may carry into the openings and disturb people inside.

Avoid installations under roof overhangs without guttering. Water draining from the roof onto the unit could produce excessive noise, and may cause ice to build up on coil or fan.

Placement of the unit should be in a well drained area or the unit **MUST** be supported high enough so runoff will not enter the unit.

Do not locate unit where heat, lint or exhaust fumes will be discharged on unit (as from dryer vents.)

Clearances

Minimum clearances, as specified in **FIGURE 1**, **MUST** be maintained from adjacent structures to provide adequate air circulation and room for service personnel.

While minimum clearances are acceptable for safety reasons, they may not allow adequate air circulation around the unit for proper operation. Whenever possible, it is desirable to allow additional clearance, especially around the condenser inlet and discharge openings.

Do **NOT** install the unit in a recessed or confined area that will permit discharged air from the condenser to recirculate to the condenser inlet.

Minimum Clearances to Combustible Construction

SERVICE ACCESS CLEARANCES

Blower Access Panel Side 30" (762mm)
 Evaporator/Electrical Access Panel Side 30" (762mm)

OPERATIONAL CLEARANCES

Combustible Base
 (Wood or Class A, B or C
 roof covering material) 0"
 Supply and Return Air Ducts 0"
 Duct Connection Side
 0"
 Clearance between Overhang
 and Top of Unit 48" (1219mm)
 Clearance around Condenser Coil area to wall or shrubs . 10"

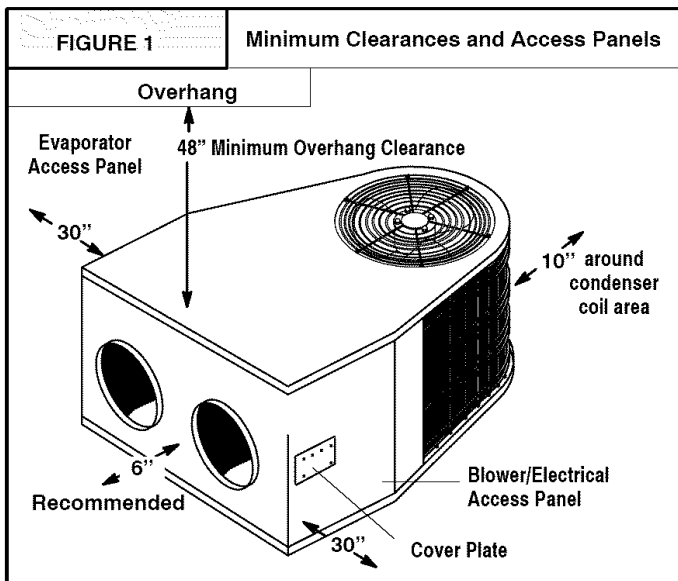

Installation

NOTE:

The unit must be installed with a slope no greater than 1/8" per foot (10mm per meter). For side to side leveling, the condensate drain side side MUST always be lower.

- The unit **MUST** be situated in such a way as to provide safe access for servicing.
- The platform may be made of either concrete or pressure treated wood and **MUST** be level and strong enough to support the unit's weight.
- Position platform separate from the building's foundation.
- Install in a well-drained area, with the top surface of the platform above grade level and above the average winter snow levels to prevent coil blockage.
- Platform **MUST** be high enough to allow for proper condensate drainage.

Installing Duct Collars

Duct collars are supplied with the unit but are not factory installed. The collars are shipped under the blower motor. See Figure 2.

1. Remove the collars from under the blower motor.
2. Position flange holes with existing screw holes on side wrapper.
3. Install screw in each collar so it goes through both of the holes in the collar and wrapper.

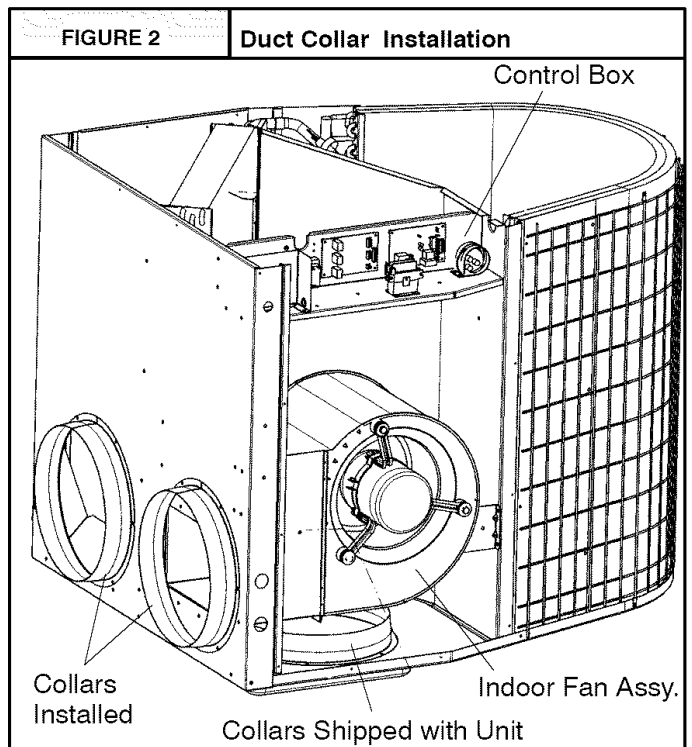

Converting 230V Units to 208V

To convert 230V units to 208V:

1. Turn electric power **OFF**.
2. Remove the blower/electrical access panel.
3. Locate the 24V control transformer.
4. Remove wire from the terminal labeled "240V" on the 24V control transformer and reconnect it to the 208V terminal of the 24V control transformer.
5. Replace the electrical/compressor access panel.

Low Voltage Wiring

For access, remove the electrical control/blower access panel.

Refer to the connection wiring diagram for the applicable model and to the instructions included with the thermostat.

Route low voltage wires through the port located on the rear panel and up to the control box.

NOTE: If an Electric Heat Accessory is installed, see the Electric Heat Accessory *Installation manual* for low voltage connections.

Thermostat Connections

The location of the thermostat has an important effect on the operation of the unit. See the thermostat instructions for proper connection. See **FIGURE 4** for Low Voltage Wire Harness Connections

Field Installed Equipment

Wiring to be done in the field between the unit and other devices, or between separate devices which are field installed and located, **MUST NOT** exceed the temperature limitations for type T wire and **MUST** be installed in accordance with manufacturer's instruction and applicable local codes.

Final Electrical Check

Make a final wiring check to be sure system is correctly wired. Inspect field installed wiring and the routing to ensure that rubbing or chafing due to vibration will not occur.

NOTE: Wiring **MUST** be installed so it is protected from possible mechanical damage.

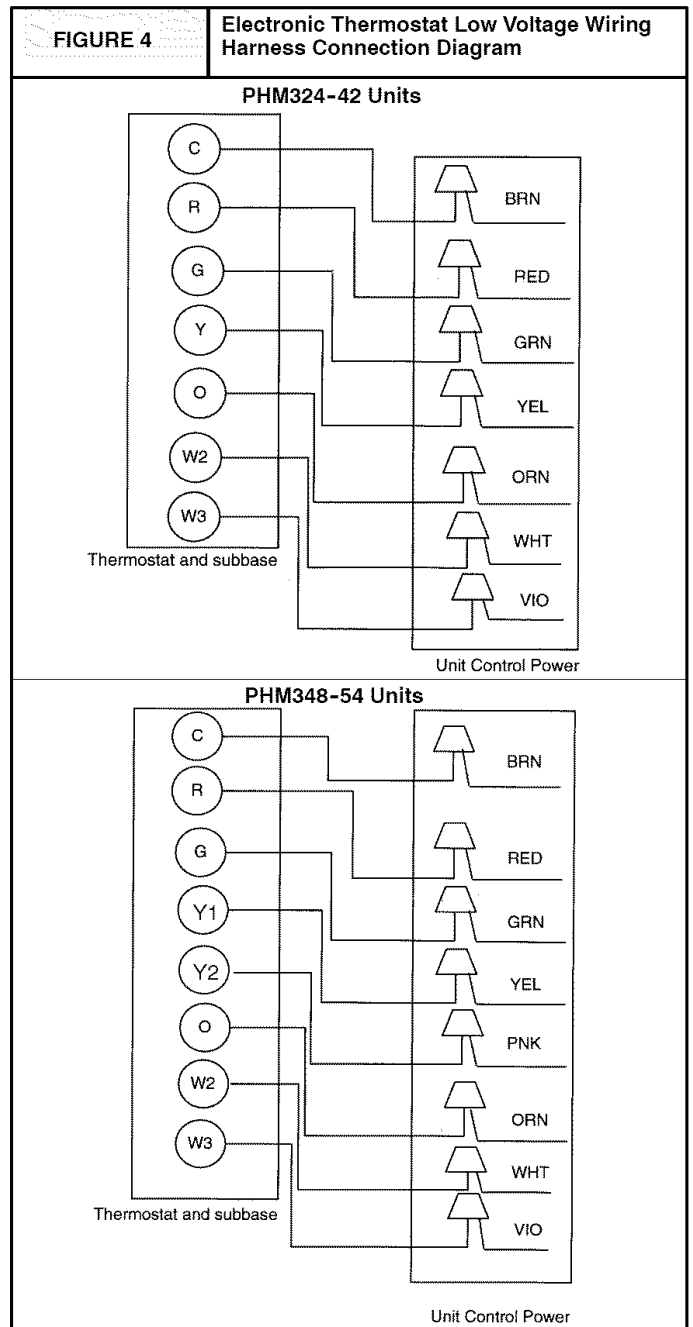
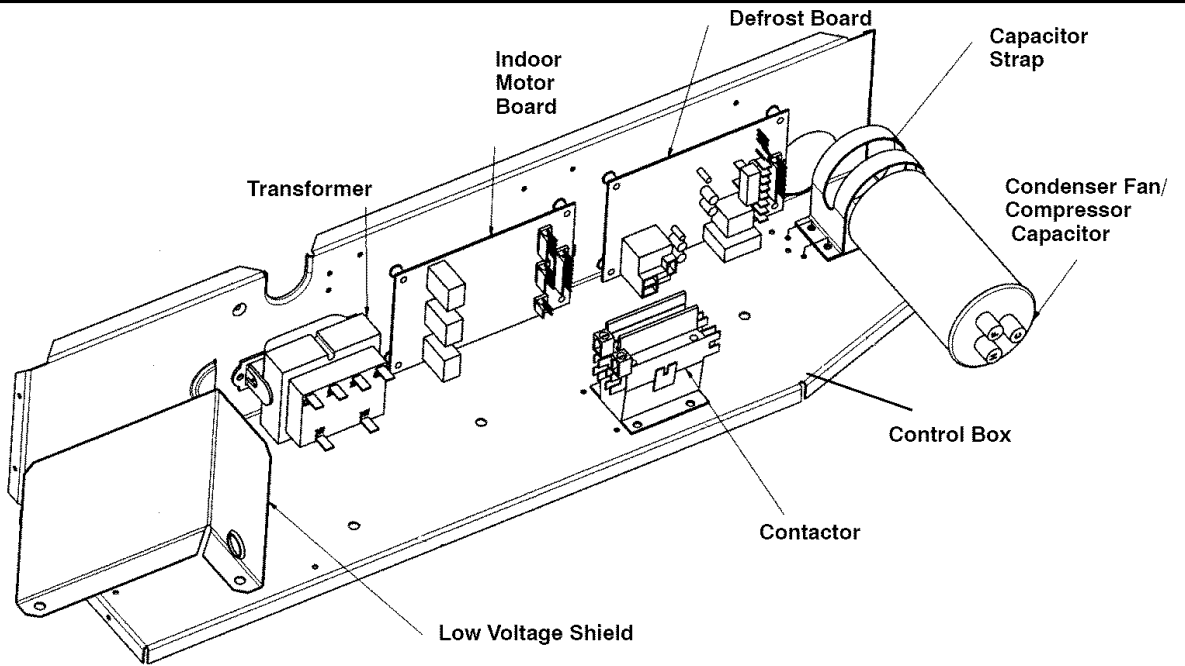
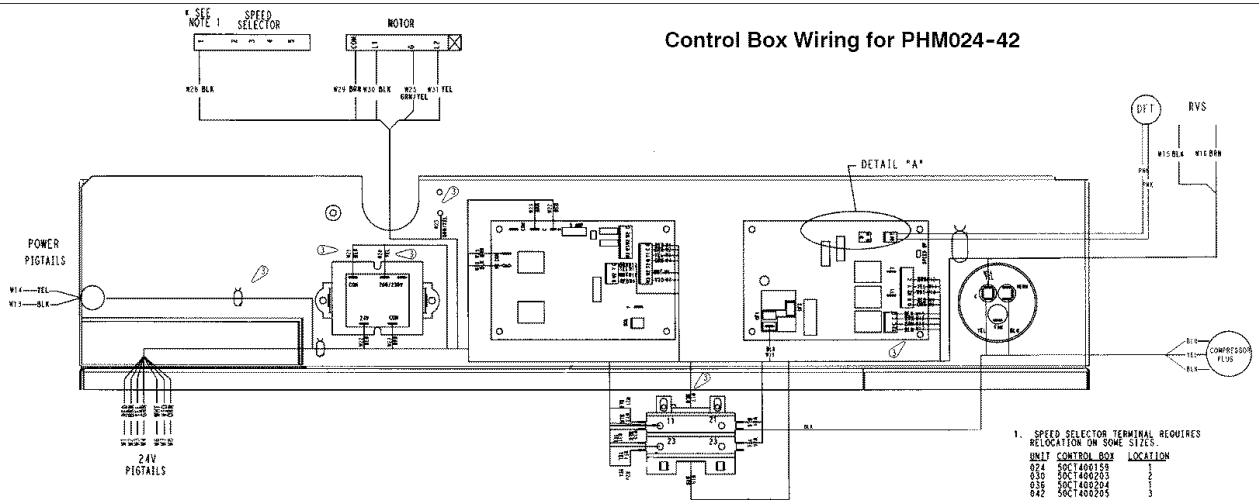

FIGURE 5

Control Box Configuration



Control Box Wiring for PHM024-42



SINGLE CAPACITY CONTROL BOX - 208/230/1

Control Box Wiring for PHM048-54

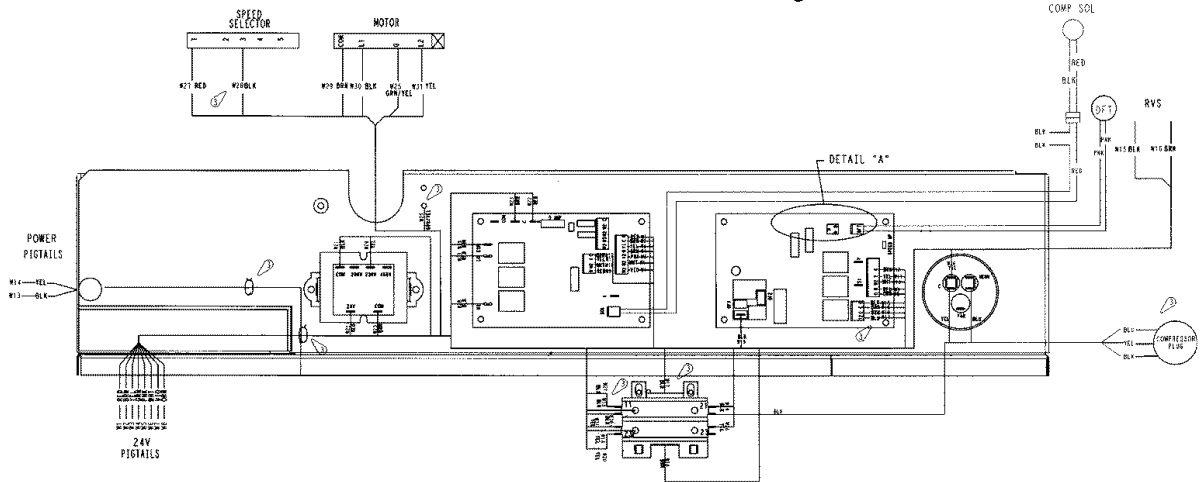

DUAL CAPACITY CONTROL BOX 208/230/1

DETAIL "A" DEFROST TIMER TO BE SET AT 60 MINUTES (DEFAULT POSITION)

2-3 1/2 Ton Models

SCHEMATIC
208/230-1-60

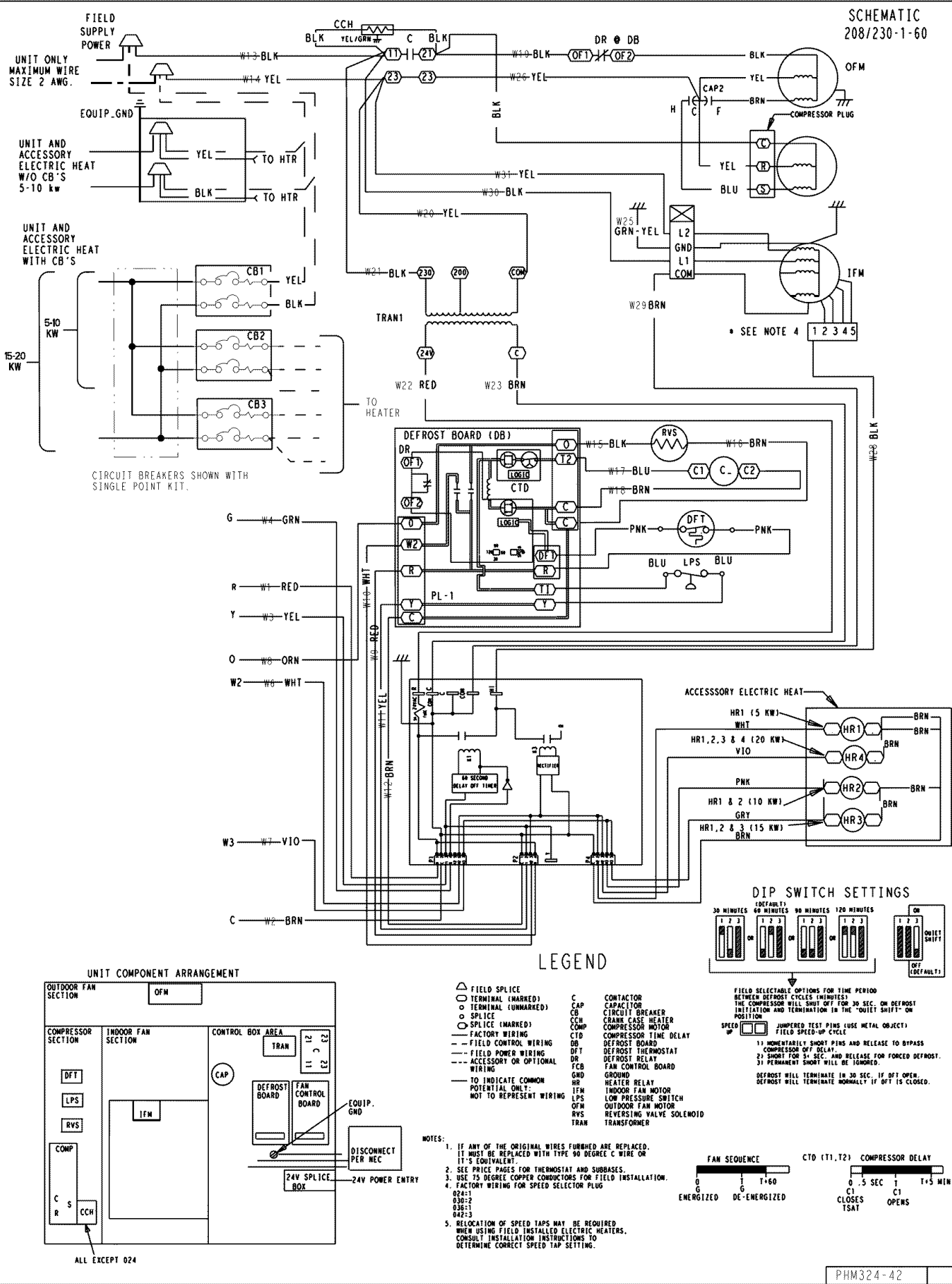

CIRCUIT BREAKERS SHOWN WITH SINGLE POINT KIT.

- G W4 GRN
- R W1 RED
- Y W3 YEL
- O W6 ORN
- W2 W6 WHT
- W3 W7 VIO
- C W2 BRN

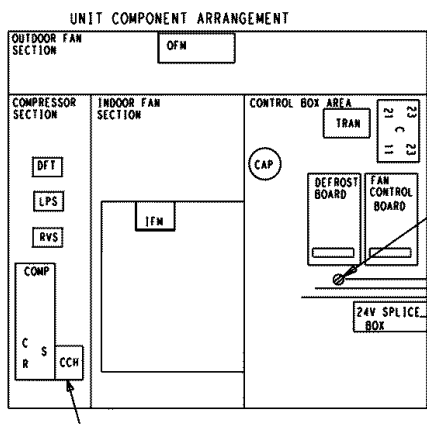

LEGEND

- △ FIELD SPLICE
- TERMINAL (MARKED)
- TERMINAL (UNMARKED)
- SPLICE
- SPLICE (MARKED)
- FACTORY WIRING
- - - FIELD CONTROL WIRING
- - - FIELD POWER WIRING
- - - ACCESSORY OR OPTIONAL WIRING
- - - TO INDICATE COMMON POTENTIAL ONLY; NOT TO REPRESENT WIRING
- C CONTACTOR
- CAP CAPACITOR
- CB CIRCUIT BREAKER
- CCH CRANK CASE HEATER
- COM COMPRESSOR MOTOR
- CTD COMPRESSOR TIME DELAY
- DB DEFROST BOARD
- DR DEFROST THERMOSTAT
- DR DEFROST RELAY
- FCB FAN CONTROL BOARD
- GND GROUND
- HR HEATER RELAY
- IFM INDOOR FAN MOTOR
- LPS LOW PRESSURE SWITCH
- OFN OUTDOOR FAN MOTOR
- RVS REVERSING VALVE SOLENOID
- TRAN TRANSFORMER

- NOTES:
- IF ANY OF THE ORIGINAL WIRES FURNISHED ARE REPLACED, IT MUST BE REPLACED WITH TYPE 90 DEGREE C WIRE OR IT'S EQUIVALENT.
 - SEE PRICE PAGES FOR THERMOSTAT AND SUBBASES.
 - USE 75 DEGREE COPPER CONDUCTORS FOR FIELD INSTALLATION.
 - FACTORY WIRING FOR SPEED SELECTOR PLUG:
024-1
030-2
036-1
042-3
 - RELOCATION OF SPEED TAPS MAY BE REQUIRED WHEN USING FIELD INSTALLED ELECTRIC HEATERS. CONSULT INSTALLATION INSTRUCTIONS TO DETERMINE CORRECT SPEED TAP SETTING.

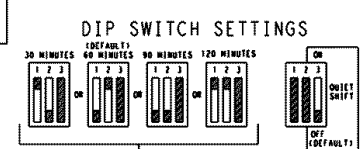
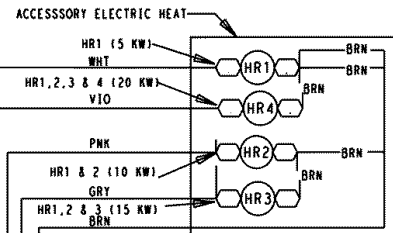

FIELD SELECTABLE OPTIONS FOR TIME PERIOD BETWEEN DEFROST CYCLES (MINUTES). THE COMPRESSOR WILL SHUT OFF FOR 30 SEC. ON DEFROST INITIATION AND TERMINATION IN THE "QUIET SHIFT" ON POSITION.

1) MOMENTARILY SHORT PINS AND RELEASE TO BYPASS COMPRESSOR OFF DELAY.
2) SHORT FOR 31 SEC. AND RELEASE FOR FORCED DEFROST.
3) PERMANENT SHORT WILL BE IGNORED.

DEFROST WILL TERMINATE IN 30 SEC. IF OFF OPEN. DEFROST WILL TERMINATE NORMALLY IF OFF IS CLOSED.

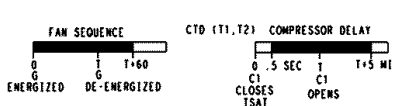

PHM324-42

4 & 5 Ton Model

SCHEMATIC
208/230-1-60

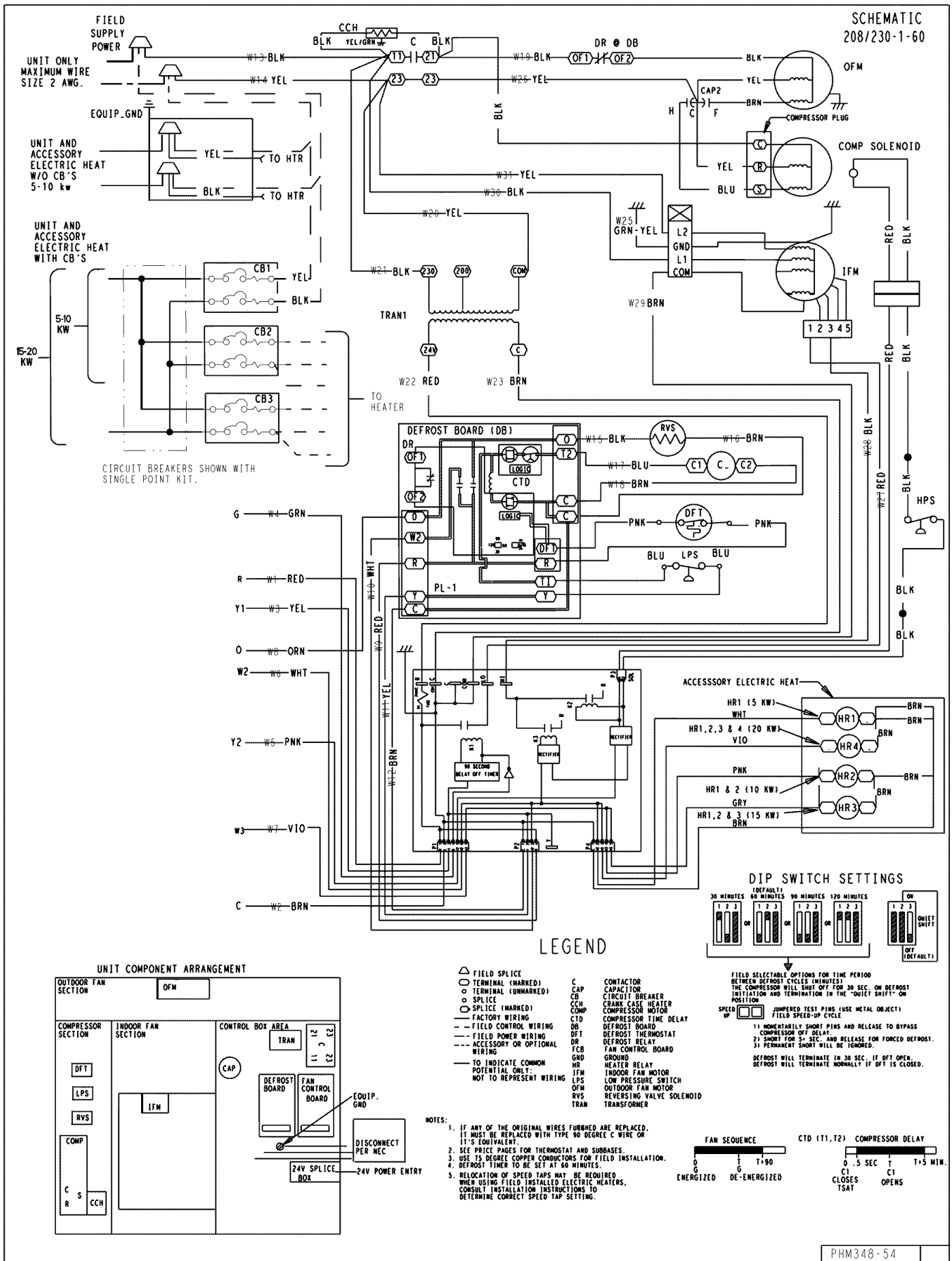

CIRCUIT BREAKERS SHOWN WITH SINGLE POINT KIT.

- G W4 GRN
- R W1 RED
- Y1 W3 YEL
- O W6 ORN
- W2 W6 WHT
- Y2 W5 PNK
- W3 W7 VIO
- C W2 BRN

LEGEND

- △ FIELD SPLICE
 - TERMINAL (MARKED)
 - TERMINAL (UNMARKED)
 - SPLICE
 - SPLICE (MARKED)
 - FACTORY WIRING
 - - - FIELD CONTROL WIRING
 - - - FIELD POWER WIRING
 - - - ACCESSORY OR OPTIONAL WIRING
 - TO INDICATE COMMON POTENTIAL ONLY; NOT TO REPRESENT WIRING
- C CAPACITOR
 - CB CIRCUIT BREAKER
 - CCH CRANK CASE HEATER
 - COMP COMPRESSOR MOTOR
 - CTD COMPRESSOR TIME DELAY
 - DB DEFROST BOARD
 - DFT DEFROST THERMOSTAT
 - DR DEFROST RELAY
 - FCB FAN CONTROL BOARD
 - GND GROUND
 - HR HEATER RELAY
 - IFM INDOOR FAN MOTOR
 - LPS LOW PRESSURE SWITCH
 - OFM OUTDOOR FAN MOTOR
 - RVS REVERSING VALVE SOLENOID
 - TRAN TRANSFORMER

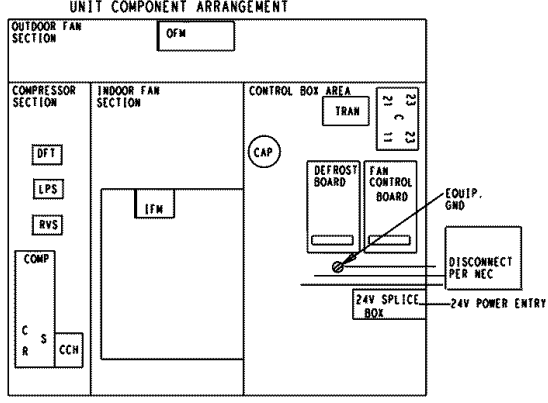
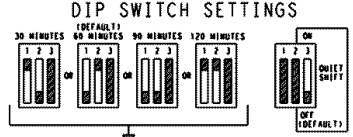

- NOTES:
- IF ANY OF THE ORIGINAL WIRES FURNISHED ARE REPLACED, IT MUST BE REPLACED WITH TYPE 90 DEGREE C WIRE OR IT'S EQUIVALENT.
 - SEE PRICE PAGES FOR THERMOSTAT AND SUBBASES.
 - USE 15 DEGREE COPPER CONDUCTORS FOR FIELD INSTALLATION.
 - DEFROST TIMER TO BE SET AT 60 MINUTES.
 - RELOCATION OF SPEED TAPS MAY BE REQUIRED WHEN USING FIELD INSTALLED ELECTRIC HEATERS. CONSULT INSTALLATION INSTRUCTIONS TO DETERMINE CORRECT SPEED TAP SETTING.

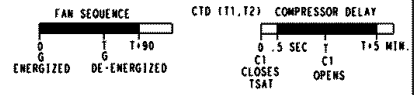

PHM348-54

6. Rain Shield Installation

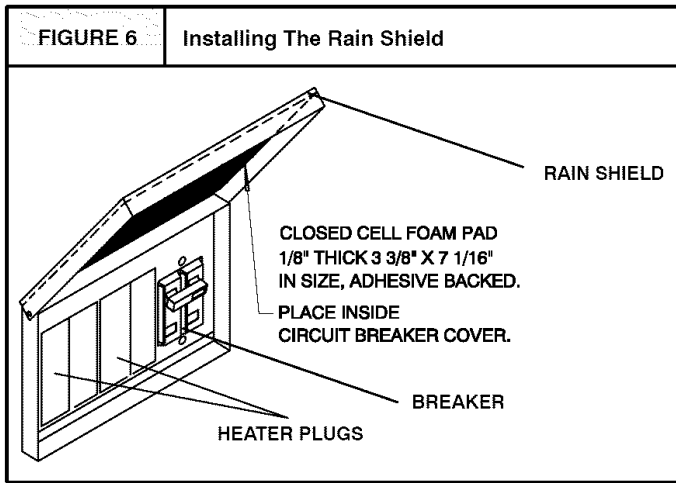

1. Remove all screws from the cover plate on Blower/Electrical Access Panel.
2. Install adhesive backed gasket on Blower/Electrical Access Panel.
3. Install lower frame of rain shield with 4 screws.
4. Install rain shield hinged cover with 4 screws.
5. Install circuit breaker filler plates (2 each per unused breaker slot.)
6. Re-install Blower/Electrical Access Panel.

NOTE: VERIFY ALL APPROPRIATE SEALS ARE IN PLACE. SEE FIGURE 6.

7. Air Distribution System

For airflow data (blower performance data, blower speed tap settings, etc.) see the *Technical Data Sheet* attached to the unit.

Ductwork

NOTE: The total heat gain of the structure to be conditioned as expressed in total Btu/hr should be calculated by manufacturer's method or in accordance with "A.S.H.R.A.E. Guide" or "Manual J - Load Calculations" published by the Air Conditioning Contractors of America. The total heat gain calculated should be equal to or less than the cooling capacity output based on D.O.E. test procedures, steady state efficiency times input.

Ductwork, supply registers, and return air grilles **MUST** be designed and sized to handle the unit's cooling air volume

requirements. If the unit is connected to an existing system, the ductwork **MUST** be checked to make sure it is adequate. Extra runs or larger duct sizes may have to be installed.

Maximum recommended velocity in trunk ducts is 1000 feet per minute (5.08m/s). Velocity in branches should not exceed 800 feet per minute (4.06m/s). Refer to the *Technical Data Label on the unit* for unit air volume requirements and system sizing recommendations.

NOTE: Ductwork sizing affects temperature rise and cooling temperature differential. Be sure to properly size ductwork to the capacity and airflow characteristics of your unit. Failure to do so can affect limit controls, compressors, motors, and other components and will lead to premature failure of components. This will also adversely affect day to day unit performance.

Flexible Duct Kits are available from your supplier to effect proper sizing and installation to **Mobile Homes and other standard construction.**

Refer to unit rating plate for proper Electric Heat Accessory sizing and see the *Temperature Rise Check* section in the Electric Heat Accessory *Installation* manual.

Ductwork Insulation

It is recommended that ductwork installed outdoors have a minimum of 2" (51mm) of fiberglass insulation and be covered by a weatherproof vapor barrier that is protected against damage. Caulking and flashings, or other means adequate to provide a permanent weather seal, must be used.

It is recommended that ductwork installed in attics or other areas exposed to outdoor temperatures have a minimum of 2" (51mm) fiberglass insulation and have an indoor type vapor barrier.

Ductwork Connections

The use of flexible, **non-combustible** connectors between main trunk ducts and supply and return air plenums is recommended to minimize vibration transmission .

NOTE: Connect supply and return air plenums to unit in a manner that will allow the top of the unit to be removed without removing plenums. Plenums **MUST** be individually sealed to unit casing. Ducts **MUST** be terminated inside structure.

Filters

All return air **MUST** pass through a field supplied filter before entering the unit. If used, an electronic air cleaner **MUST** be installed in the *return* air ductwork. Minimum recommended filter areas are listed in **FIGURE 7** and are based on a velocity of 300 ft./min. (1.2m/s) for disposable filters and 500 ft./min. (2.54m/s) for washable high velocity filters.

NOTE:

Do NOT operate the unit without all filters in place.

FIGURE 7		Recommended Filter Sizes	
NOTE: Some filters are marked with an arrow to indicate the proper direction of air flow through the filter. The air flow direction will be towards the blower motor. Make sure filter is installed correctly.			
Nominal Tons Air Conditioning	Nominal Air Flow Cubic Feet per Minute	Recommended Filter Sizes Sq. In. Surface Area/Nominal Size	
		Disposable Filters	Cleanable Filters
2	700 - 900	400 or 20 x 25	246 or 15 x 20
2 1/2	875 - 1125	487 or 20 x 30	301 or 14 x 25
3	1050 - 1350	576 or 14 x 25 (2Req.)	356 or 16 x 25
3 1/2	1225 - 1575	665 or 16 x 25 (2Req.)	411 or 20 x 25
4	1400 - 1800	753 or 20 x 25 (2 Req.)	466 or 20 x 25
5	1750 - 2000	960 or 20 x 30 (2 Req.)	575 or 24 x 25

8. Start-up Procedures

WARNING

ELECTRICAL SHOCK HAZARD.

Failure to follow this warning could result in personal injury, and/or death.

Use extreme care during all of the following checks and procedures.

Make sure electric power is turned OFF as instructed in appropriate steps.

Circulating Air Blower

Determining Blower Speed

1. Turn electric power OFF.

2. From the system design, determine the total external static pressure (ESP) for the supply ducts, return ducts and registers, diffusers, grilles, dampers, heaters and filters.

3. To your system ESP determined in **Step 2**, add 0.05 In. W.C. for a wet coil.

4. From the system design, determine the desired cooling airflow in cubic feet per minute (CFM).

5. Locate the unit's Blower Performance Data table in Figure 8. From the table, determine the speed tap required to achieve the desired airflow.

6. See next section, *Speed Taps*, to set the blower motor speed terminal block (speed taps) to the cooling speed determined in the previous steps.

Speed Taps

After determining the required CFM and speed tap data from the Figure 8, follow the steps below to change speeds if necessary.

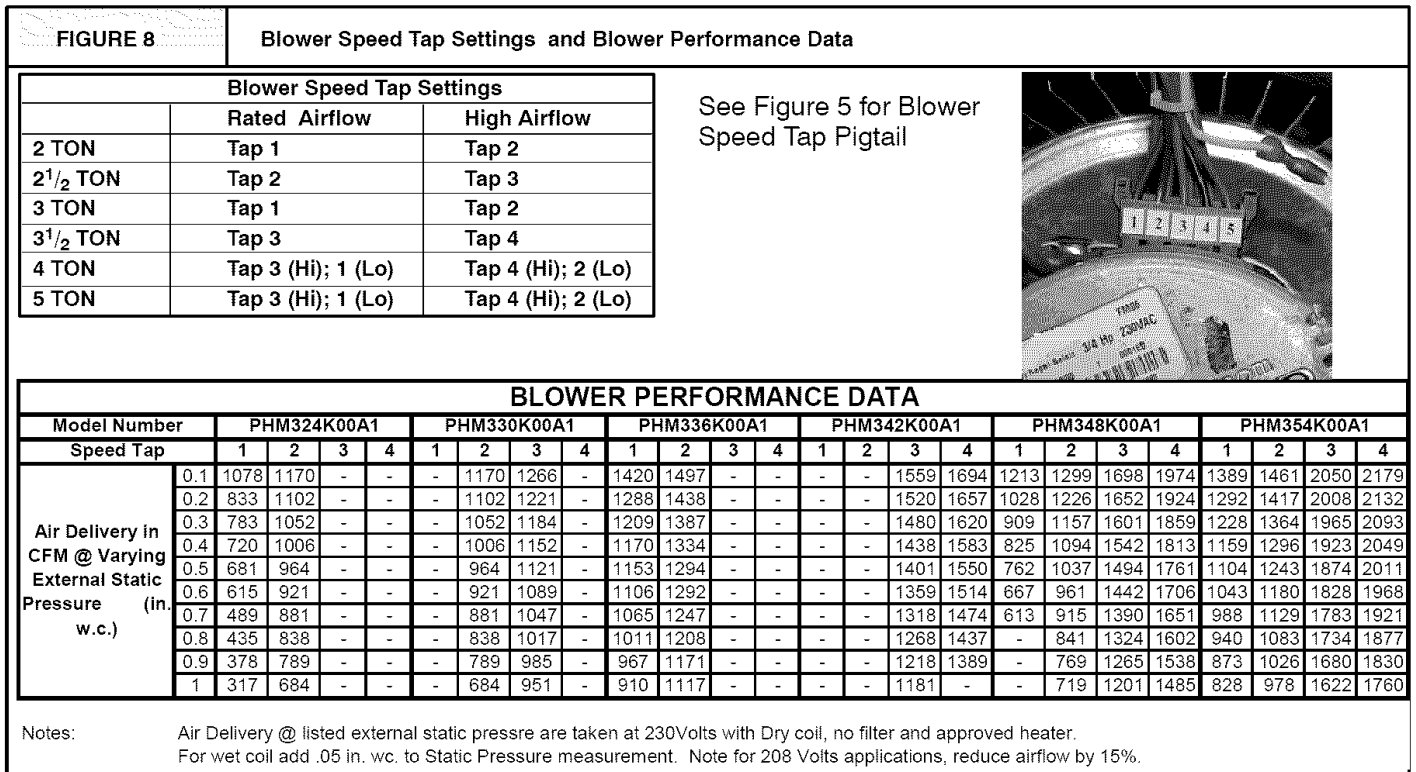

NOTE: On Heat Pumps Electric heater blower wire must be attached to the same speed tap required for cooling/heat pump operation. The **yellow** lead **MUST** always be connected to the speed tap block at the common quick connect terminal. The terminal is identified as **COM**.

Refer to Figures 5 and 8 and the appropriate unit wiring diagram included in this manual. Wire the black wire to the required speed tap terminal to achieve required airflow determined in **Step 5**.

Cooling, Heating (Heat Pump) and Auxiliary Electric Strip Heat

NOTE: The cooling, heat pump and strip heat airflows are all on the same speed tap. The refrigerant system requires the same specific CFM for proper operation in the cooling and the heat pump mode. For this reason, cooling and heating airflow must be the same. **DO NOT SPLIT OUT INTO A COOLING SPEED AND**

HEATING SPEED. If auxiliary electric heat is installed, the auxiliary electric heat blower speed wire must be connected to the black wire insulated quick connect terminal.

Check Before Starting

1. Check that the blower motor speed terminal block is set to the proper cooling speed. Refer to the unit wiring diagram and the various airflow tables in this manual.
2. Check to see that clean, properly sized field supplied air filters are installed in the return air duct.
3. Inspect the inside of the unit to be sure that all wires are in place and all tools, etc. are removed.
4. Replace all service access panels.

Check the unit's operation as outlined in the following instructions. If any unusual sparking, odors or noises are

encountered, shut **OFF** electric power immediately. Recheck for wiring errors, or obstructions in or near blower motors.

Circulating Air Blower

1. Be sure electric power is **OFF**.
2. Set thermostat Heat-Cool selector to **OFF**.
3. Set thermostat fan switch to **AUTO**
4. Turn electric power **ON**. Nothing should start running.
5. Set thermostat fan switch to **ON**. The circulating air blower should come **ON**.
6. Reset thermostat fan switch to **AUTO**. The circulating air blower should go **OFF** after a 60 second delay for models PHM324-42 and 90 second delay for PHM348-54. Nothing should be running.

Cooling

1. Be sure that electric power is **OFF**.
2. Set thermostat Heat-Cool select to **COOL**.
3. Adjust thermostat setting to below room temperature.
4. Turn electric power **ON**. During power application check the following:
 - a. Contactor - Contacts closing
 - b. Compressor - **ON**
 - c. Condenser fan motor - **ON**
 - d. Circulating air blower - **ON** (after delay)
5. Switch the thermostat to **OFF**, check the following:
 - a. Contactor contacts opening.
 - b. Compressor - **OFF**
 - c. Condenser fan motor - **OFF**
 - d. Circulating blower - **OFF** (after delay)
6. Turn electric power **OFF**

Defrost Control Time Interval Adjustment

WARNING

ELECTRICAL SHOCK HAZARD.

Failure to follow this warning could result in personal injury and/or death.

Turn **OFF** electric power supply at disconnect switch or service panel before removing any access or service panel from unit.

To adjust defrost interval:

1. Turn off all power to Heat Pump.
2. Remove control box cover.
3. Locate electronic defrost control board.
4. The Defrost Control Board has a dip switches that can be set at 30, 60, 90 or 120 minutes. Factory setting is 60 minutes. See Figure 10 for Defrost settings. For service test, refer to sequence of operation for defrost mode on next page.

Figure 10 Defrost Dip Switch Settings

DIP SWITCH SETTINGS

FIELD SELECTABLE OPTIONS FOR TIME PERIOD BETWEEN DEFROST CYCLES (MINUTES): THE COMPRESSOR WILL SHUT OFF FOR 30 SEC. ON DEFROST INITIATION AND TERMINATION IN THE "QUIET SHIFT" ON POSITION

SPEED UP JUMPED TEST PINS (USE METAL OBJECT) FIELD SPEED-UP CYCLE

- 1) MOMENTARILY SHORT PINS AND RELEASE TO BYPASS COMPRESSOR OFF DELAY.
- 2) SHORT FOR 5+ SEC. AND RELEASE FOR FORCED DEFROST.
- 3) PERMANENT SHORT WILL BE IGNORED.

DEFROST WILL TERMINATE IN 30 SEC. IF DFT OPEN. DEFROST WILL TERMINATE NORMALLY IF DFT IS CLOSED.

DEFROST BOARD

DIP SWITCHES

9. Sequence of Operation

Cooling Operation (PHM324-42)

(1) On a call for cooling (Y)

The indoor fan energizes immediately where as the contactor energizes after a 5 minute time delay (in case of an initial start up) starting the compressor and the outdoor fan motor.

(2) When the cooling setpoint has been satisfied

When the cooling demand is met, (Y) de-energizes, shutting off the compressor, indoor fan and the outdoor fan.

Cooling Operation (PHM348-54)

(1) On a call for cooling

These units utilize a 2 stage indoor thermostat. With a first stage call for cooling (Y1), the indoor fan (low stage) energizes immediately where as the contactor energizes after a 5 minute time delay (incase of an initial start up) starting the compressor (low stage) and the outdoor fan motor. If the low stage operation cannot satisfy the cooling demand, the second stage cooling (Y2) energizes switching the compressor into high stage cooling through energizing an internal solenoid valve inside the scroll compressor and switching the indoor fan into high stage.

(2) When the cooling setpoint has been satisfied

When second stage cooling is satisfied, Y2 de-energizes switching the compressor and the indoor fan into low stage cooling. When the low stage cooling demand is met, Y1 de-energizes shutting off the compressor, indoor fan and the outdoor fan.

Heating Operation (PHM324-42)

(1) On a call for heating.....:

With a call for heating (Y), the indoor fan (low stage) energizes immediately where as the contactor energizes after a 5 minute time delay (incase of an initial start up) starting the compressor and the outdoor fan motor. If (Y) cannot satisfy the heating demand, the auxiliary or back up heat (W2) energizes. Incase of staged heating, W3 is energized if the demand is not met. The highest airflow selected is run while the electric heat is in operation.

(2) When the heating setpoint has been satisfied

When heating demand is met, W3, W2 and Y sequentially de-energize shutting off the compressor, indoor fan and the outdoor fan.

Heating Operation (PHM348-54)

(1) On a call for heating.....:

With a first stage call for heating (Y1), the indoor fan (low stage) energizes immediately whereas the contactor energizes after a 5 minute time delay (in case of an initial start up) starting the compressor (low stage) and the outdoor fan motor. If the low stage operation cannot satisfy the heating demand, the second stage heating (Y2) energizes switching the compressor into high stage heating through energizing an internal solenoid valve inside the scroll compressor and switching the indoor fan into high stage. The auxiliary or back up heat is controlled by a third stage (W2). If the demand is not met, W3 is energized in case of staged heating.

(2) When the heating setpoint has been satisfied

When heating demand is satisfied, W3, W2 and Y2 sequentially de-energize switching the compressor and the indoor fan into low stage heating. When the low stage heating demand is met, Y1 de-energizes shutting off the compressor, indoor fan and the outdoor fan.

Continuous Fan

With the continuous Indoor fan option selected on the thermostat, G is continuously energized. On 024 - 042 units, the selected airflow setting is provided. On 048 and 054 units, the system runs low stage (Y1) airflow for continuous fan operation.

Defrost Mode:

(1) On a call for defrost.....

When the defrost sensor closes in the heating mode, there is a 30, 60, 90 or 120 minute delay before the defrost mode begins. This delay is selected by the position of the dipswitches on the defrost board. Defrost interval timing can be configured by selection switch 1 and 2. See Figure 10.

1. The backup defrost terminate time is fixed at 10 minutes.
2. The compressor recycle delay timer is 5 minutes.
3. The power interrupt response is minimum 17 msec. to maximum 35 msec.
4. Quite shift compressor recycle delay is 30 seconds.

In normal defrost mode, the following sequence will occur after the set delay:

1. Condenser fan off.
2. Reversing valve energized to cooling and auxiliary electric heat (W2) is energized.
3. After defrost sensor opens or a maximum of 10 minutes; the condenser fan is energized (after 20 seconds) and the reversing valve is de-energized to the heat mode. Electric strip heat is also de-energized (after 15 seconds) except as required by the thermostat.
4. Should the system indoor thermostat be satisfied during the defrost cycle, the control will de-energize the reversing valve and auxiliary heat outputs and "hold" the defrost timer until the next call for heat, at which time the defrost cycle will be completed.

Service testing: the pins marked "speed up" when momentarily shorted together (for 5 seconds) and released, will defeat the 5 minutes recycle delay timer and allow the compressor contactor to be immediately energized, thus forcing a defrost cycle. Termination of this forced mode will be by the defrost thermostat or the 10 minute backup timer, provided the defrost thermostat was closed when the defrost was "forced." If the defrost thermostat was not closed, at the time of the "forced defrost," the defrost mode will remain for 30 seconds and then terminate.

Adding Accessories

Low/High Pressure Controls

This unit is equipped with extra low and high pressure ports located inside the unit panel where the external high and low pressure ports are installed. This allows for installation of high and low pressure controls or low ambient controls.

10. Operation

Scroll Recycle Delay Timer

The defrost board is equipped with a recycle delay timer which will delay the start of the compressor for 5 minutes in the event of a power interruption. This sequence powers throughout the system and prevents possible reverse rotation of the scroll compressor. The output of the timer controls the compressor contactor via a normally open contact of K3 (T2). The timer starts the delay cycle when the compressor is turned off by removal of "Y." If application of "Y" occurs before the timer has expired, the compressor contactor will not be energized until the timer has expired.

 CAUTION
REDUCED EQUIPMENT LIFE HAZARD
Failure to follow this caution may result in premature component failure.
Do NOT operate unit on cooling when the outdoor temperature is below 45°F or PHM324 and 40°F for PHM330-54. This is necessary to prevent possible damage to the compressor.

Pressure Switch

Loss of Charge Pressure Switch: Units are equipped with a low pressure switch on the liquid line (high side) which has been installed to prevent system damage due to a loss of charge. The switch will open and de-energize the contactor if the high side pressure drops below the set point of the switch.

High Pressure Switch: The PHM348-54 are equipped with a high pressure switch to protect the compressor.