

Hisense

life reimagined

USER'S OPERATION MANUAL

Before operating this unit, please read this manual thoroughly, and retain for future reference

English

Contents

Brief introduction.....	2	Using your appliance.....	8
Important safety instructions.....	2	Helpful hints and tips.....	10
Installing your new appliance.....	4	Cleaning and care.....	11
Description of the appliance.....	6	Troubleshooting.....	12
Display controls.....	6	Disposal of the appliance.....	13

Brief introduction

Thank you for your choosing our products. We are sure you will find your new appliance a pleasure to use. Before you use the appliance, we recommend that you read through these instructions carefully, which provides details about its usage and functions.

● Please ensure that all people using this appliance are familiar with its operations and safety features. It is important that you install the appliance correctly and pay attention to the safety instructions carefully.

● We recommend that you keep this user's manual with the appliance for future reference and retain it to any future users

● This appliance is intended to be used in household and similar applications such as:

- Staff kitchen- areas in shops, offices and other working environments;
- Farmhouses by clients in hotels, motels and other residential types of environment;
- Bed and breakfast type of environments.

● If you feel that the appliance is not operating correctly, please check the Troubleshooting page for assistance. If still in doubt contact the customer service help line for assistance or to arrange a call out by an authorized service engineer.

Important safety instructions

General safety and daily use



It is important to use your appliance safely. We

recommend that you follow the guidelines below.

Store any food in accordance with the storage instructions from the manufacturer.

Don't use mechanical devices or any other means to speed up the defrosting process, unless they are approved by the manufacturer.

● Don't try to repair the appliance yourself. It is dangerous to alter the specifications or modify this product in any way. Any damage to the cord may cause short circuit, fire or electric shock.

● Pay attention not to damage the tubing of the refrigerant circuit.

● Don't place too much food directly against the air outlet on the rear wall of both the refrigerator and freezer compartment, as it affects sufficient air circulation.

- Don't place hot items near the plastic components of this appliance.
- Frozen food must not be refrozen once it has been thawed out.
- Don't store bottled or canned drinks (especially carbonated drinks) in the freezer compartment. Bottles and cans may explode.
- Do not consume ice popsicles or ice cubes straight from the freezer as this can cause freezer burn to the mouth and lips.
- To avoid items falling and causing injury or damage to the appliance, do not overload the door racks or put too much food in the crisper drawers.

Safety for children and infirm persons



This appliance is not intended for use by persons (including children) with reduced physical, sensory or mental capabilities, or a lack of experience and knowledge, unless they have been given supervision or instruction concerning the use of the appliance by a person responsible for their safety. Children should be supervised to ensure that they do not play with the appliance.

- Keep all packaging away from children to avoid risk of suffocation.
- Protect children from being scalded by touching the very hot compressor at the rear bottom of appliance
- Don't place items on top of the appliance as this could cause injury should they fall off.
- Never allow children to play with the appliance by hanging or standing over or on the doors, racks, shelves and drawers etc.

Safety about electricity



To avoid the risks that are always present when using an electric appliance, we recommend that you pay more attention to the instructions about electricity below.

- Unpack the appliance and check through the appliance. Should any damage be evident, don't plug in the appliance but contact the store immediately from which you purchased it. Keep all packing materials in this case.
- We recommend that you wait for 4 hours before connecting the appliance to allow the refrigerant to flow back into the compressor.
- The appliance must be applied with single phase alternating current of 115V/60Hz. If the voltage fluctuates exceeding the upper limit, A.C. automatic voltage regulator of more than 350W should be applied to the refrigerator for safety use.
- The mains plug must be accessible when the appliance is installed.
- This appliance must be earthed.
 - This appliance is fitted with a fused plug in accordance with local standard. The fused plug should be suitable for use in all houses fitted with sockets in accordance with current specifications.
 - If the fitted plug is not suitable for your socket outlets, please contact a qualified, registered electrician.
- Do not use extension cords or multiple sockets which could cause overloading of wiring circuits and could cause a fire. Always plug your appliance into its own individual electrical socket which has a voltage rating that matched the rating plate.
- Make sure that the plug is not squashed or damaged. Otherwise, it may cause short circuit, electric shock or overheat and even cause a fire.
- Do not insert the mains plug if the socket is loose, there is a risk of electric shock or fire.
- **Switch off the appliance and disconnect it from the mains power before you clean or move it.**

- Never unplug the appliance by pulling on the electrical cord. Always grip the plug firmly and pull straight out from the socket to prevent damaging the power cord.
- Do not operate the appliance without the light cover of interior lighting.
- Any electrical component must be replaced or repaired by a qualified electrician or authorized service engineer. Only genuine spares should be used.
- Do not use electrical appliances such as ice cream makers inside the food storage compartments of the appliance, unless they are approved by the manufacturer.
- Do not look direct into the LED light located in the refrigerator compartment with optical instruments to avoid eye injuries. If it is not functioning correctly, consult a qualified, registered electrician or replace it in accordance with the “cleaning and care” chapter.



Hazard of fire

The appliance contains a small quantity of refrigerant (R600a) which is environmentally friendly but **potentially** flammable in the refrigerant circuit.

- Pay attention not to damage tubing of the refrigerant circuit during transportation and installation to avoid risk of fire caused by leaking refrigerant.
- **Avoid** candles, lamps and other items with open flames and sources of ignition near the appliance, Ventilate the room thoroughly to avoid the risk of fire and eye injury should any leakage of refrigerant occur.
- Do not store products which contain flammable propellants (e.g. spray cans) or explosive substances in the appliance.
- The room space must be at least 1m³ per 8g of refrigerant. The amount of refrigerant in your appliance is indicated on the rating plate inside.

Installing your new appliance

Before using the appliance for the first time, you should be informed of the following tips.



Caution: risk of fire .

The refrigerant (R600a) is flammable. The refrigerant is contained within the refrigerant circuit of the appliance, a natural gas with a high level of environment compatibility, which is nevertheless potentially flammable. **WARNING**—Do not damage the refrigerant circuit during handling, moving, installing and use of the appliance. Follow the installing and using instructions. **WARNING**—Do not try to repair the appliance yourself. Contact a qualified service engineer or the store where you purchased the product.

CAUTION—Risk of fire or explosion due to puncture of refrigerant tubing; Follow handling instructions carefully.

Ventilation of appliance



In order to improve efficiency of the cooling system and save energy, it is necessary to maintain good ventilation around the appliance for the dissipation of heat. For this reason, sufficient clear space should be available around the refrigerator. It is advisable for there to be at least 75mm (3”) of space from the back to the wall, at least 100mm (4”) from its top, at least 100mm (4”) from its side to the wall and a clear space in front to allow the doors to open 132°. As shown in following diagrams.

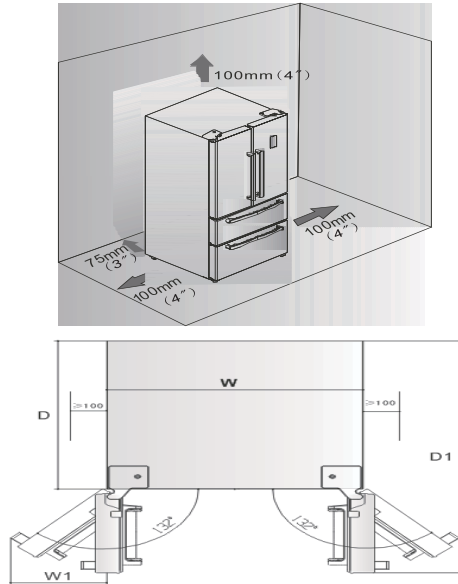

Relevant information

Model \ Constant /mm	W	W ₁	D	D ₁
RF15N1BSD	700	287.5	625	992.5

Model \ Constant /in	W	W ₁	D	D ₁
RF15N1BSD	27.5	11.3	24.6	39

Note:

This appliance performs well from 12.8°C to 43.3°C. The Appliance may not work properly if it is left for a longer period at a temperature above or below the indicated range.

- Stand your appliance in a dry place to avoid high moisture.

- Keep the appliance out of direct sunlight, rain or frost. Stand the appliance away from heat sources such as stoves, fires or heaters.

Leveling of appliance

The appliance should be level in order to eliminate vibration. We recommend that you level the appliance by the following steps.

1. Roll the refrigerator into place.
2. Turn the adjustable feet (with your fingers or a suitable spanner) until it touches the floor.

3. To allow the doors to self-close, tilt back the top backwards for about 10mm(4") or 0.5° by turning the adjustable feet.

4. Whenever you want to move the appliance, remember to turn the feet back up so that the appliance can roll freely. Reinstall the appliance when relocating.

Caution! The rollers, which are not castors, should be only used for forward or backward movement. Moving the refrigerator sideways may damage your floor and the rollers.

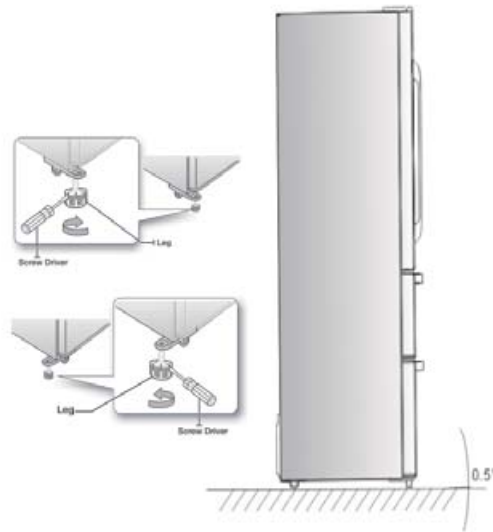

After the installation

- After you have successfully installed the appliance, you should clean it thoroughly before using. Cleaning

Installing the door handles

Before you use the appliance, please check the handle. If the handle is loose you should fix it with a hexangular screwdriver in the clockwise direction until handles are securely in place.

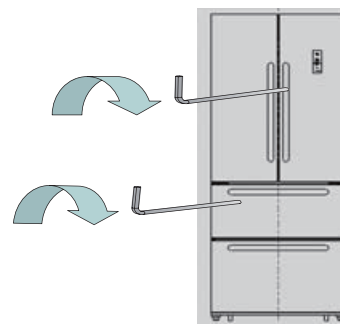

Description of the appliance

1. Covered upper rack
2. Upper rack
3. Wind channel cover in fresh
4. Second rack
5. Glass shelf
6. Flexible-shelf
7. LED light(inside)
8. Bottle rack
9. Middle rack
10. Crisper cover
11. Door seal
12. Flipper clapboard
13. Wind channel cover in fresh
14. Upper freezer
15. Upper freezer drawer
16. Upper freezer basket
17. Lower freezer
18. Lower freezer
19. Lower freezer drawer
20. Lower freezer basket
21. Adjustable feet

View of the appliance

RF15N1BSD

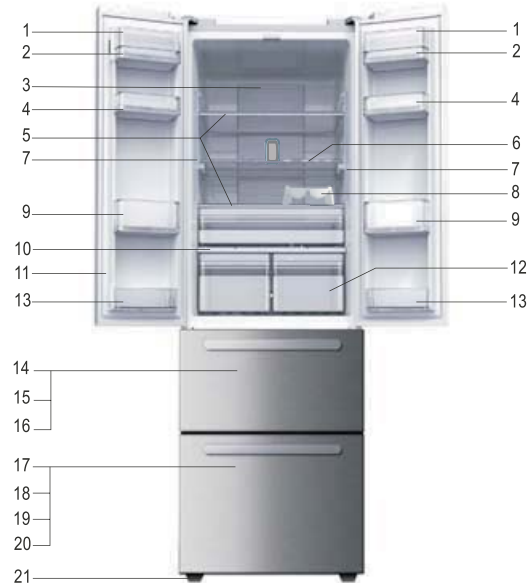

Note: Due to unceasing modification of our products, your refrigerator may be slightly different from this Instruction Manual, but its functions and using methods remain the same.

Note: Shelves and drawers are arranged for optimum energy efficiency on delivery.

Display controls



The control panel consists of two areas indicating temperatures, six icons representing different modes and 3 touch buttons. When the appliance is powered on for the first time, the backlighting of the icons on display panel starts working. If no buttons have been pressed and the doors are closed, the backlighting will turn off automatically after 60 seconds.

Adjusting the temperature

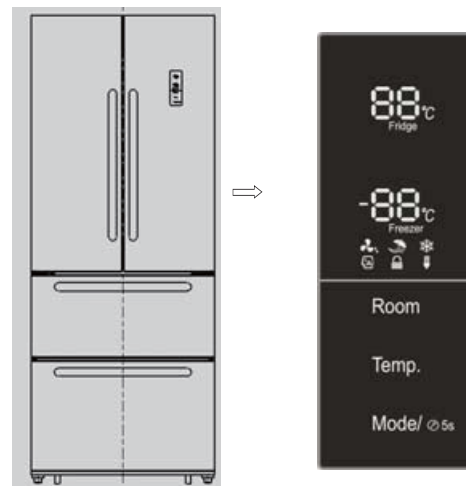
We recommend that when you start your refrigerator for the first time, the temperature for the refrigerator is set to 3°C and the freezer to -18°C. If you want to change the temperature, follow the instructions below.



Caution! When you set a temperature, you set an average temperature for the whole refrigerator cabinet. Temperatures inside each compartment may vary from the temperature values displayed on the panel, depending on how much food you store and where you place them. Ambient temperature may also affect the actual temperature inside the appliance.

All the buttons are locked if the icon “” is illuminated, press the “Mode/5s” button for 5 seconds to unlock them.

1. Room.

You can activate Fridge OR Freezer compartment temperature setting by pressing “room” button.

2. Temp.

After fridge temperature setting is activated, press “Temp.” button to set fridge temperature between 8°C and 2°C as needed. And the control panel will display corresponding value according to the following sequence.



After freezer temperature setting is activated, press “Temp.” button to set fridge temperature between -15°C and -21°C as needed. And the control panel will display corresponding value according to the following sequence.

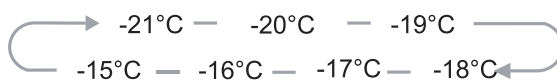

3. Mode/5s

You can select different modes by pressing the “Mode/5s” button. When certain mode is selected, wait for the corresponding icon to flash for 10 seconds. Buzzer will sound two times

afterwards and the icon will be illuminated, which means the setting is completed.

4. Super cool

Super Cool can refrigerate your food much faster, keeping food fresh for a longer period



● When the super cool function is activated, the “” light will be illuminated.

● Super cool automatically switches off after 6 hours and the refrigerator temperature setting displays 2°C.

5. Super Freeze

Super Freeze can quickly lower frozen temperature and freeze your food faster than usual. This can lock the vitamins and nutrition of fresh food and keep your food longer.



● In case of the maximum amount of food to be frozen, please wait for about 24 h.

● Super freeze automatically switches off after 26 hours and the freezer temperature setting displays -24°C.

6. Energy saving

When the function is activated, the temperature of refrigerator is automatically switched to 8°C and the temperature of freezer is automatically switched to -15°C.

7. Smart

When the function is activated, the temperature of refrigerator is automatically adjusted

Note: If you want to switch off the mode you have selected, simply press the “Room” button and set the temperature of corresponding compartment as you need.

8. Holiday



If you are going to be away for a long period of time such as a long holiday or business trip, you can activate this function by pressing “Holiday” button for 3 seconds until the light will be illuminated.

● When the holiday function is activated, the temperature of the fridge is automatically switched to 15°C to minimize the energy consumption.

Important! Do not store any food in the fridge during this time, or they will soon go off.

9. Door Alarm

● When door of fridge or freezer is open for over 2 minutes, door alarm will sound and the fridge or freezer will display “dA” on the control panel. In case of door alarm, buzzer will sound 3 times per minute and stop alarm 10 minutes later.

● To save energy, please avoid keeping doors open for a long time when using refrigerator. In case of door alarm, you can clear door alarm by closing the doors.

10. Temperature alarm

● If freezer temperature is too high due to power failure or other reasons, it will give temperature alarm and the freezer temperature setting displays “--”.

● In case of temperature alarm, buzzer will sound constantly for 10 times.

● In case of temperature alarm, press “Alarm” button for 3 seconds to check the highest freezer temperature. The temperature value and “Alarm” icon will simultaneously flash for 5 seconds.

Caution! When power is restored, it is normal to appear temperature alarm and you can press “Alarm” button to clear it.

Using your appliance

1. Using your refrigerator compartment

The refrigerator compartment is suitable for storage of vegetables and fruit. Food inside shall be packed to store in order to avoid losing moisture or flavor permeating into other foods.

Caution! Never close the refrigerator door while the shelves, crisper and/or telescopic slides are extended. It may damage both them and the refrigerator.

Door rack

- It is suitable for the storage of eggs, canned liquid, bottled drinks and packed food, etc. Do not place too many heavy things in the racks
- The middle door shelf can be placed at different heights according to your requirements. Please take food out of the shelf before lifting vertically to reposition.

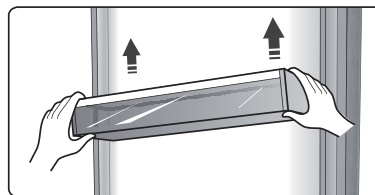

Bottle holder operation

● The bottle holder can be used to fix the bottle. You can place it on the middle or lower door rack and slide to

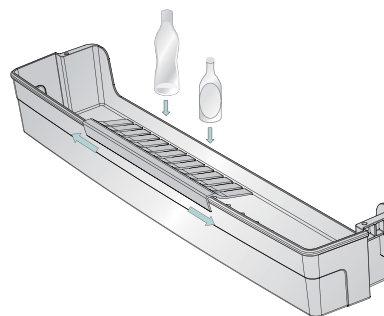

Shelf in refrigerator chamber

- There are three glass shelves in refrigerator chamber. They can be adjusted to various heights as needed.
- When you remove the shelves, gently pull them forward until the shelf comes clear of the shelf guides.
- When you re-install the shelves, make sure there is no obstacle behind and gently push the shelf back into the position.
- All the door racks and covers are completely removable for cleaning.

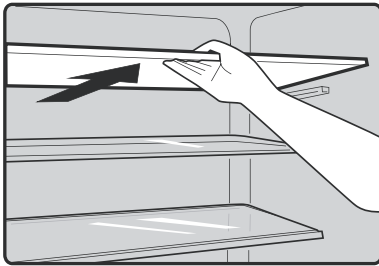

Bottle rack

- It is for storing bottled wine or drinks.

Crispers

- The crisper, mounted on telescopic extension slides, is for storing vegetables and fruits.
- When you remove the crispers, pull them forward, then separate the crisper from the slides. Remember to empty food in the crisper first. Once you have removed the drawers, ensure the slides are pushed back fully.

Crisper cover

- It is for controlling the temperature of the crisper and avoiding the vegetable losing moisture. You can adjust the humidity inside the crisper by using the sliding block.

2. Using your freezer drawer

- The freezer drawers are suitable for storage of foods required to be frozen, such as meat, ice cream and others.

The drawers

- The drawers are mounted on telescopic extension slides and can be removed in the same way as removing the crispers in the

removing the crispers in the refrigerator compartment.

Caution! Ensure that bottles are not stored in the freezer as freezing may cause the bottle to explode.

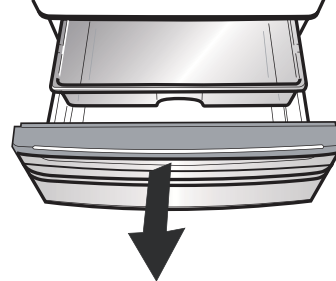

The way to pull out the crisper.

Twistable ice maker

It is used to make and deposit ice cubes. You should use it as follows.

1. Pull out the twistable ice maker from the installation bracket in the freezer drawer.
2. Place the ice maker on level.
3. Pour water into the ice trays and the water line shall not exceed the top line of ice tray.
4. Place the filled ice maker back to the bracket.
5. When ice cubes form, twist the knobs clockwise and the ice will drop into the ice box below.
6. Ice cubes can be stored in the ice box, if you need them, you can pull out the ice box and take them out.

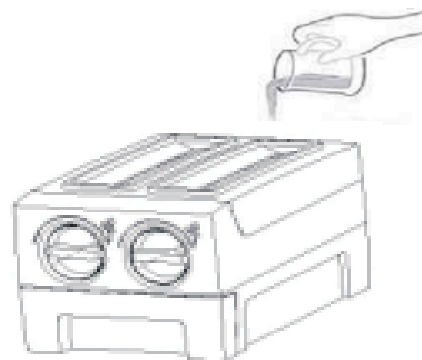

Note: If the ice tray is used for the first time or has not been used for a long time, please clean it before using.

Helpful hints and tips

Energy saving tips

We recommend that you follow the tips below to save energy.

- Try to avoid keeping the door open for long periods in order to conserve energy.
- Ensure the appliance is away from any sources of heat (direct sunlight, electric oven or cooker etc)
- Don't set the temperature colder than necessary.
- Don't store warm food or evaporating liquid in the appliance.
- Place the appliance in a well ventilated, humidity free room. Please refer to Installing your new appliance chapter.
- If the diagram shows the correct combination for the drawers, crisper and shelves, do not adjust the combination as this is designed to be the most energy efficient configuration.

Hints for fresh food refrigeration

- Do not place hot food directly into the refrigerator or freezer. The internal temperature will increase resulting in the compressor having to work harder and consuming more energy.
- Do cover or wrap the food, particularly if it has a strong flavor.
- Place food properly so that air can circulate freely around it.

Hints for refrigeration

- Meat (all types) wrapped in polythene food should be wrapped and placed on the glass shelf above the vegetable drawer. Always follow food storage times and use by dates suggested by food manufacturers.
- Cooked food, cold dishes, etc should be covered and may be placed on any shelf.
- Fruit and vegetables should be stored in the vegetable crisper.
- Butter and cheese should be wrapped in airtight foil or plastic film wrap.

film wrap.

- Milk bottles should have a lid and be stored in the door racks.

Hints for freezing

- When first starting-up or after a period out of use, let the appliance run at least 2 hours on the higher settings before putting food in the compartment.
- Prepare food in small portions to enable it to be rapidly and completely frozen and thawed.
- Wrap up the food in aluminum foil or polyethylene food wraps which are airtight.
- Do not allow fresh, unfrozen food to touch the food which is already frozen to avoid temperature rise of the latter.
- Iced products, if consumed immediately after removal from the freezer compartment, will probably cause frost burns to the skin.
- It is recommended to label and date each frozen package in order to keep track of the storage time.

Hints for the storage of frozen food

- Ensure that frozen food has been stored correctly by the food retailer.
- Once defrosted, food will deteriorate rapidly and should not be re-frozen. Do not exceed the storage period indicated by the food manufacturer.

Switching off your appliance

If the appliance needs to be switched off for an extended period, the following steps should be taken to prevent mould on the appliance.

1. Remove all food.
2. Remove the power plug from the mains socket.
3. Clean and dry the interior thoroughly.
4. Ensure that all the doors are wedged open slightly to allow air to circulate.

Cleaning and care

For hygienic reasons the appliance (including exterior and interior accessories) should be cleaned regularly at least every two months.

Caution! The appliance must not be connected to the mains during cleaning to avoid potential electrical shock. Before cleaning, please switch off the appliance off and remove the plug from the mains socket.

Exterior cleaning

To maintain good appearance of your appliance, you should clean it regularly.

-Wipe the digital panel and display panel with a clean, soft cloth.

-Spray water onto the cleaning cloth instead of spraying directly on the surface of the appliance. This helps ensure an even distribution of moisture to the surface.

-Clean the doors, handles and cabinet surfaces with a mild detergent and then wipe dry with a soft cloth.

Caution!

-Don't use sharp objects as they are likely to scratch the surface.

-Don't use Thinner, Car detergent, Clorox, ethereal oil, abrasive cleansers or organic solvent such as Benzene for cleaning. They may damage the surface of the appliance and may cause fire.

Interior cleaning

You should clean the appliance interior regularly. It will be easier to clean when food stocks are low. Wipe the inside of the fridge freezer with a weak solution of bicarbonate of soda, and then rinse with warm water using a wrung-out sponge or cloth. Wipe completely dry before putting the shelves and baskets back.

Thoroughly dry all surfaces and removable parts.

Although this appliance automatically defrosts, a layer of frost may occur on

the freezer compartment's interior walls if the freezer door is opened frequently or kept open too long. If the frost is too thick, choose a time when the supply of food stocks are low and proceed as follows:

1. Remove existing food and accessories baskets, unplug the appliance from the mains power and leave the doors open. Ventilate the room thoroughly to accelerate the thawing process.

2. When defrosting is completed, clean your freezer as described above.

Caution! Don't use sharp objects to remove frost from the freezer compartment. Only after the interior is completely dry should the appliance be switched back on and plugged back into the mains socket.

Door seals cleaning

Take care to keep door seals clean. Sticky food and drinks can cause seals to stick to the cabinet and tear when you open the door. Wash seal with a mild detergent and warm water. Rinse and dry it thoroughly after cleaning.

Caution! Only after the door seals are completely dry should the appliance be powered on.

Replacing the LED light:

Warning! The LED light must not be replaced by the user! If the LED light is damaged, contact the customer helpline for assistance. To replace the LED light, the below steps can be followed:

1. Unplug your appliance.
2. Remove light cover by pushing up and out.
3. Hold the LED cover with one hand and pull it with the other hand while pressing the connector latch.
4. Replace LED light and snap it correctly in place.

Troubleshooting

If you experience a problem with your appliance or are concerned that the appliance is not functioning correctly, you can carry out some easy checks before calling for service, please see below.

Warning! Don't try to repair the appliance yourself. If the problem persists after you have made the checks mentioned below, contact a qualified electrician, authorized service engineer or the shop where you purchased the product.

Problem	Possible cause & Solution
Appliance is not working correctly	Check whether the power cord is plugged into the power outlet properly.
	Check the fuse or circuit of your power supply. Replace if necessary.
	The ambient temperature is too low. Try setting the chamber temperature to a colder level to solve this problem.
	It is normal that the freezer is not operating during the automatic defrost cycle, or for a short time after the appliance is switched on to protect the compressor.
Odours from the compartments	The interior may need to be cleaned
	Some food, containers or wrapping cause odours.
Noise from the appliance	The sounds below are quite normal: <ul style="list-style-type: none"> ● Compressor running noises. ● Air movement noise from the small fan motor in the freezer compartment or other compartments. ● Gurgling sound similar to water boiling. ● Popping noise during automatic defrosting. ● Clicking noise before the compressor starts.
	Other unusual noises are due to the reasons below and may need you to check and take action: <ul style="list-style-type: none"> ● The cabinet is not level. ● The back of appliance touches the wall. ● Bottles or containers fallen or rolling.
The motor runs continuously	It is normal to frequently hear the sound of the motor, it will need to run more when in following circumstances: <ul style="list-style-type: none"> ● Temperature setting is set colder than necessary. ● Large quantity of warm food has recently been stored in the appliance. ● The temperature outside the appliance is too high. ● Doors are kept open too long or too often. ● After your installing the appliance or it has been switched off for a long time.
A layer of frost occurs in the compartment	Check that the air outlets are not blocked by food and ensure food is placed within the appliance to allow sufficient ventilation. Ensure that door is fully closed. To remove the frost, please refer to cleaning and care chapter.

Temperature inside is too warm	You may have left the doors open too long or too frequently; or the doors are kept open by some obstacle; or the appliance is located with insufficient clearance at the sides, back and top
Temperature inside is too cold	Increase the temperature by following the "Display controls" chapter.
Doors cant be closed easily	Check whether the top of the refrigerator is tilted back by 10-15mm to allow the doors to self close, or if something inside is preventing the doors from closing.
Water drips on the floor	The water pan (located at the rear bottom of the cabinet) may not be properly leveled, or the draining spout (located underneath the top of the compressor depot) may not be properly positioned to direct water into this pan, or the water spout is blocked. You may need to pull the refrigerator away from the wall to check the pan and spout.
The light is not working	<ul style="list-style-type: none"> ●The LED light may be damaged. Refer to replace LED lights in cleaning and care chapter. ●The control system has disabled the lights due to the door being kept open too long, close and reopens the door to reactivate the lights.

Disposal of the appliance

It is prohibited to dispose of this appliance as household waste.

Packaging materials

Packaging materials with the recycle symbol are recyclable. Dispose of the packaging into a suitable waste collection container to recycle it.

Before disposal of the appliance

1. Pull out the mains plug from the mains socket.
2. Cut off the power cord and discard with the mains plug

Warning! Refrigerators contain refrigerant and gases in the insulation. Refrigerant and gases must be disposed of professionally as they may cause eye injuries or ignition.

Ensure that tubing of the refrigerant circuit is not damaged prior to proper disposal.

Correct Disposal of this product	
	<p>This symbol on the product or in its packing indicates that this product may not be treated as household waste. Instead, it should be taken to the appropriate waste collection point for the recycling of electrical and electronic equipment. By ensuring this product is disposed of correctly, you will help prevent potential negative consequences for the environment and human health, which could otherwise be caused by the inappropriate waste handling of this product. For more detailed information about the recycling of this product, please contact your local council your household waste disposal service, or the shop where you purchased the product.</p>