

Fingerprint Access Control System User Manual

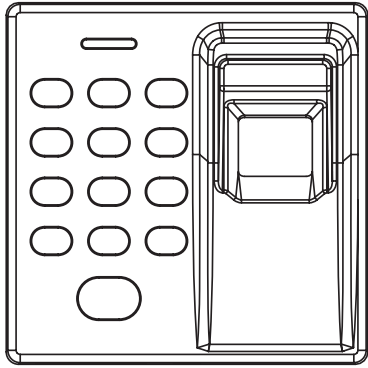

☺ Due to continuous update of our products

I. Product Overview and Installation Instruction

Applicable Models

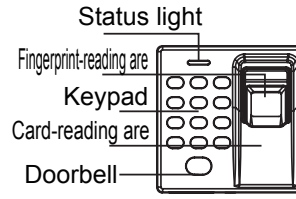

S.N.	Functions
1	Dark-background fingerprint reader
2	Built-in card reader
3	User verification with fingerprint or card
4	Numeric keys
5	Tamper alarm
6	Reading head for data output
7	86mm box-type panel for installation

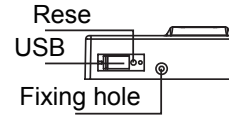

Operating Environment:
Room temperature: -20°C ~ $+50^{\circ}\text{C}$
Relative humidity: 95%
Operating Voltage & Current:
Input DC: +12V
Standby current: $\leq 60\text{mA}$
Operating current: $\leq 120\text{mA}$

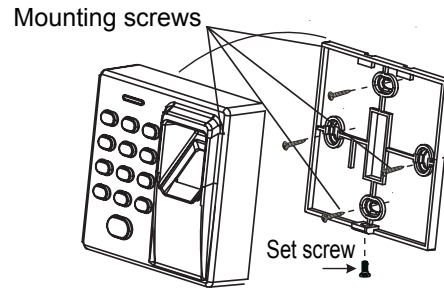

- 1 -

II. Inputting Fingerprint

Suggested finger: index finger, middle finger or ring finger instead of thumb or little finger

1) Correct method

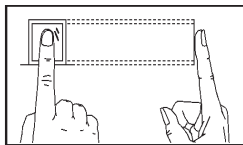

Use the finger to evenly press the center of fingerprint are

2) Wrong methods

Incomplete touch

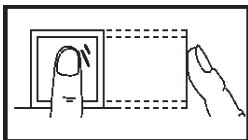

Off cente

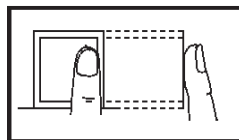

Turn sideway

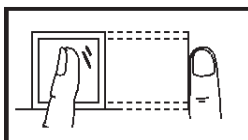

Low position

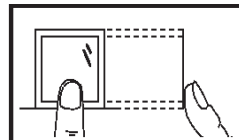

☺ Please input fingerprint correctly for verification, and improper operation might result in poor performance of this device

- 2 -

III. Ports & Wiring Diagram

Connect this device and breaker via NO, COM and NC output to separate from internal circuit of this device. Once relay gets closed, electric lock is released.

Contact output current: 3A;
connection diagram:
please refer to right diagram.

Relay Output Connection Diagram

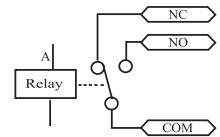

High level output in case of alar

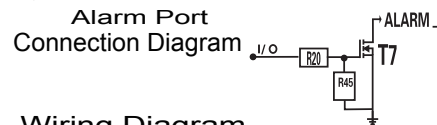

Wiring Diagram

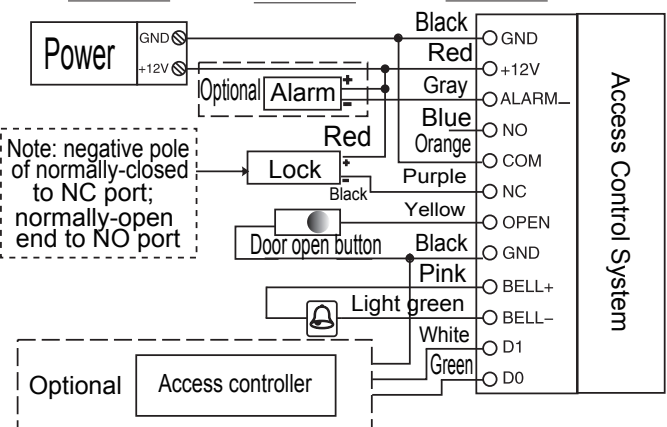

- 3 -

IV. Administrator Operation

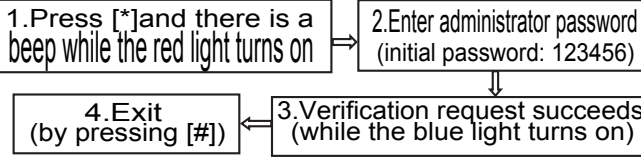

Remarks: once verification request succeeds, it is allowed to register administrator and the initial password will be out of use.

4.1 Registering Administrator

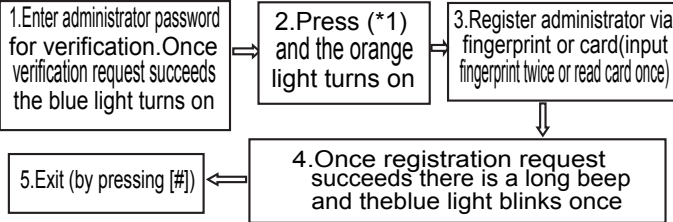

Remarks:

1. It is allowed to register at most 5 administrators via fingerprint or card
2. In case administrator quantity reaches the maximum value, they will be cleared according to serial number.

4.2 Missing Administrator Password

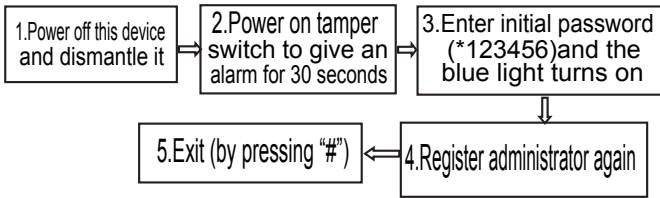

- 4 -

V: Registering User

5.1 Register Users Automatically

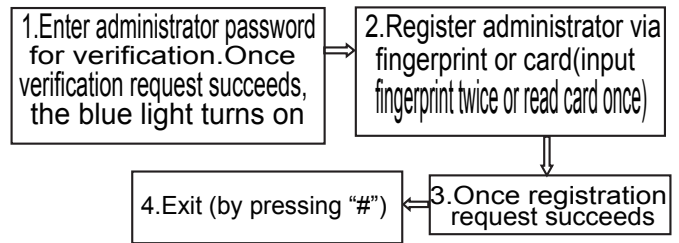

5.2 Register Users by Adding Employee ID

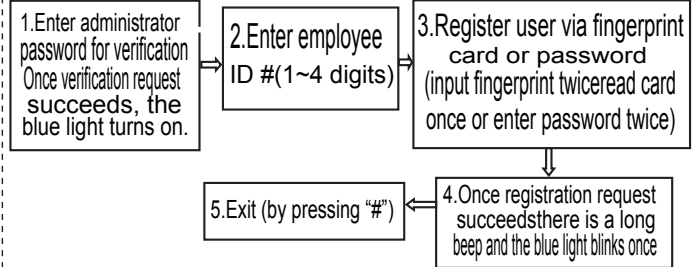

VI: User Operation

6.1 User Verification via Fingerprint or Card

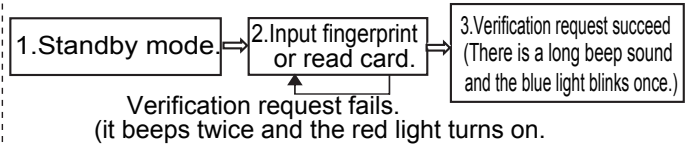

- 5 -

6.2 User Verification via Password

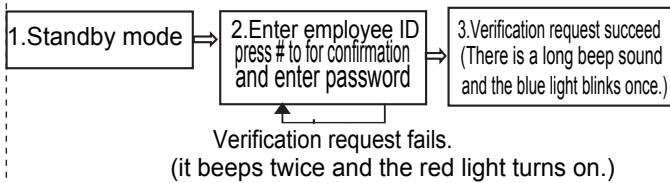

VII: Deleting Users

7.1 Delete a User

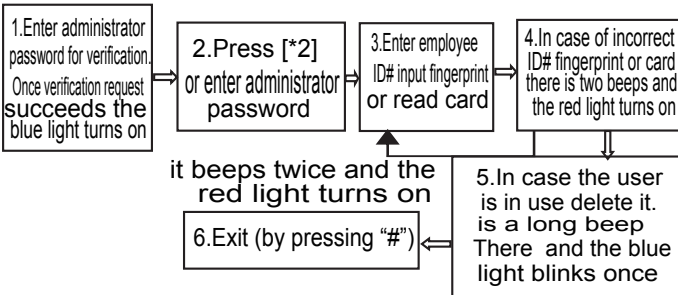

7.2 Delete All Users

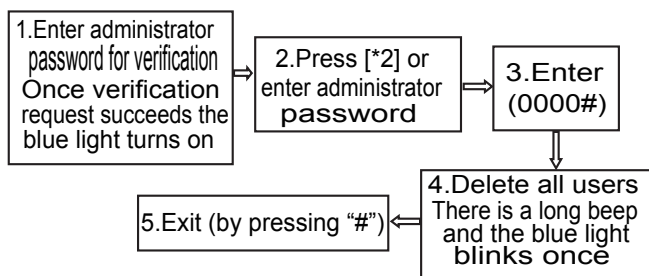

- 6 -

VIII: Access Control System Management

8.1 System Settings

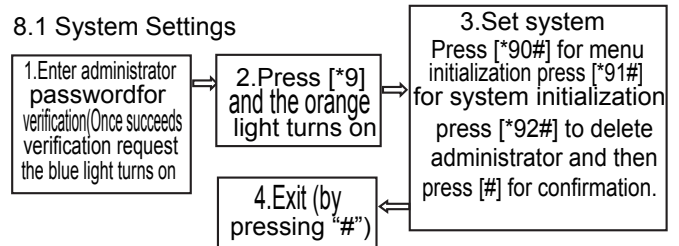

8.2 Setting Unlocking Time

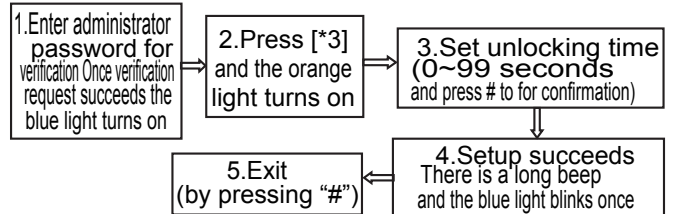

Note: 5 seconds have been set as factory default.

IX: Unpacking

Description	Specifications	Quantity	Remarks
Device		1	
Packaging box		1	
Plastic plugs	4mm X28mm	4	For mounting and fixing
Self-tapping screws	4mm X28mm	4	For mounting and fixing
Screwdriver	Rocket screwdriver	1	

7