

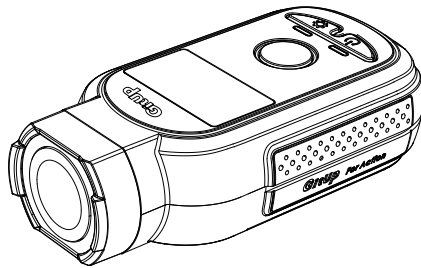

Action Camera **F1**

User Manual



GitUp Ltd

Table of Contents

Getting Started	1
The Basics	
Preparation	
Powering On/Off	
Camera Status Screen	
Camera Modes	4
Video Mode	5
Capturing Video	
Video Settings	
Photo Mode	9
Capturing Photo	
Photo Settings	
Setup Mode	12
Connecting to GitUp App	14
Transferring Files to a Computer	14
Playback on TV	15
Battery	16
Charging the battery	
Battery Storage and Handling	
Package Included	17
Optional Accessories	17
Customer Support	18

Getting Started

■ The Basics

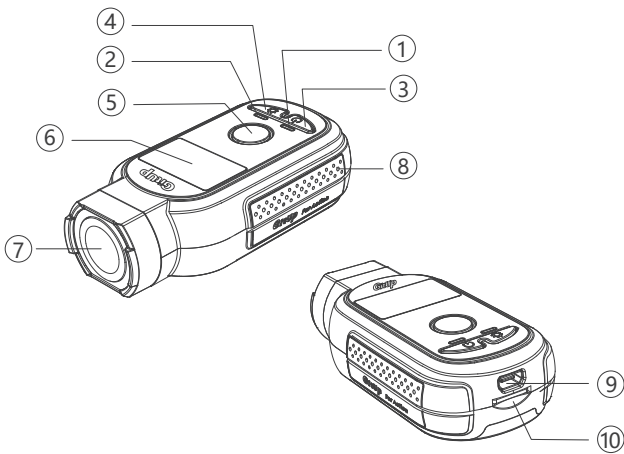

- ① Charger light / Mode light
- ② Charger light / Wi-Fi Status Light
- ③ Power / Mode Button
- ④ Menu Button
- ⑤ Shutter / Select Button
- ⑥ OLED Screen
- ⑦ Lens
- ⑧ Cooling Hole
- ⑨ Micro USB Port (supports composite A / V cable)
- ⑩ MicroSD Card Slot (microSD Card not included)

■ Preparation

1. Take the camera out of its package.
2. Insert a microSD card (microSD card is sold separately) with the label facing the battery.

Note: To remove the card, press it into the slot with your fingernail and it will pop out. The microSD card must have a Class-10 or UHS-I rating. For 4K recording, we highly recommend UHS-3 rating card, better to choose SanDisk, Transcend, Samsung brand card, the capacity is up to 128GB.

3. Charge the battery by connecting the camera to a computer or other USB charging adapter using the included USB cable. Both LED will be red during charging and turn blue when charging complete.

■ Using the Mount

The mount is specialized for bike and motorcycle sports, also it protects the camera. Follow the picture below to install the mount.

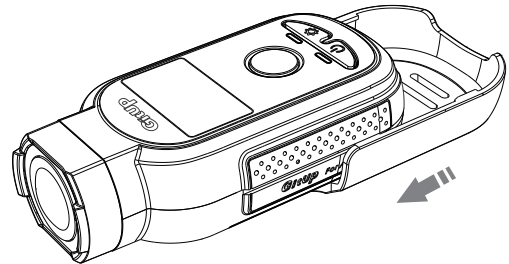

Powering On/Off

To Power On: Press and hold the Power/Mode button [] for four seconds.

To Power Off: Press and hold the Power/Mode button [] for three seconds.

PRO TIP: When the camera is off and Quik Rec is enabled, you can turn the camera on and immediately begin capturing video or Time Lapse photos just by pressing the Shutter/Select button []. Press once for video, press and hold for Time Lapse photos. Press again to stop recording and power off the camera. For details, see Quik Rec in Setup Mode.

Camera Status Screen

F1 features a status screen that displays the following information about modes and settings:







- 1 Camera Modes
- 2 Resolution/fps (frames per second)
- 3 Number of Files Captured
- 4 Left recording time
- 5 Meter
- 6 Loop Recording Interval
- 7 Battery Life

Note: The icons that appear on the camera status screen vary by mode.



Camera Modes

The F1 features several camera modes. To cycle through the modes, press the Power/Mode button [] repeatedly.



	Video	Record video or time lapse video.
	Photo	Capture a single photo or a series of photos.
	Playback	Playback videos and photos. (Playback mode appears only if the camera is connected to a TV).
	SetUp	Adjust general camera settings.

Video Mode





▪ Capturing Video

1. Press the Power/Mode button [] repeatedly until get to Video mode.
2. Press the shutter button [] to start/stop recording.

▪ Video Settings

When in the video mode, press the Menu button [] to enter video setting. Press the Shutter/Select button [] to cycle through the options within a setting. Use the Power/Mode button [] to cycle through the settings.

Mode: Video mode contains four capture modes: Looping, Normal, Time Lapse, Slow motion and Vid+Photo. Each Video mode has its own settings menu.

 Normal	Captures video.
 Time Lapse	Creates video from frames captured at specific intervals.
 SLOMO (Slow Motion)	Creates Slow Motion video, only available in 1080P@100fps, 1080P@120fps and 720P @ 200fps, 720p@240fps mode.
 Vid+Photo	Simultaneously captures both video and photos.
 Looping	Lets you continuously record and save only the best moments, which helps to conserve space on your microSD card.

Note: The video mode icon will appear in the upper left on your camera status screen.

Res (Resolution): Set the resolution of the video, resolution refers to the number of horizontal lines in the video. The F1 includes the video resolutions listed below:

Video Resolution	FPS NTSC / PAL	Screen Resolution
4K	30, 25	3840 x 2160, 16:9
2160P	30, 25	2880 x 2160 4:3
1440P	60, 50, 30, 25	1920 x 1440, 4:3
1080P	120, 100, 60, 50, 30, 25	1920 x 1080, 16:9
720P	240, 200	1280 x 720, 16:9

Interval: The Interval setting applies to Time Lapse Video, Video + Photo and Looping.

- Time Lapse Video: The intervals determines the amount of time that passes between each captured frame.
- Video + Photo: Simultaneously captures both video and photos. You can set the camera to capture a photo at selected intervals while you record. The intervals determines the time that passes between 2 photos captured during recording.
- Looping: Lets you continuously record and save only the best moments, which helps to conserve space on your microSD card. The intervals determines the time length of each video segment. When the microSD card is full, the previous video will be overwritten.

Mode	Available Interval
Time Lapse	1s, 2s, 5s, 10s, 30s, 60s
Vid+Photo	5s, 10s, 30s, 60s
Looping	1 Min, 3Min, 5Min, Max

Rate (Only available in SLOMO): Slow-motion effects are created by recording hundreds of frames per second and then playing the same frames back at a slower rate.

Quality: Normal, Fine, Super Fine for different bitrate video compression.

Stamp: Add a date stamp to your video.

Zoom: It zooms in on the center of the shot, good for capturing content at a distance, change the zoom value according to the distance between the camera and object.

Meter: The metering mode refers to the way in which the camera determines the exposure. Various metering modes (Average, Spot, and Center) are provided for a variety of lighting conditions.

WB (White Balance): White balance adjusts the overall color tone of videos. The camera can automatically adjust the white balance, or you can manually adjust the white balance.

Color: Color allows you to adjust the color profile of your video footage.

Sharpness: Sharpness controls the sharpness of your video footage. You can use High option for an ultra-sharp look, the Medium option for moderate sharpness, or the Low option for a softer look.

EV (Exposure value): Exposure value affects the level of brightness of your video. Adjusting this setting can improve image quality when shooting in environments with contrasting lighting conditions.

EIS (Electronic Image Stabilization): EIS helps the footage stay clear and stable in situations where the camera is subject to knocks and bumps. The options for this setting are On and Off (Default).



Note: Only available in 1080P@ 60fps, 1080P@ 50fps, 1080P@ 30fps, 1080P@25fps.

Audio: Turn On/Off the audio.



Calib(Calibration): It applies software correction to the lens distortion before it saves the footage file to the memory card.

Photo Mode





▪ Capturing Photo

1. Press the Power/Mode button [] repeatedly until you get to photo mode.
2. Press the shutter button [] to take a photo.

▪ Photo settings

When in the photo mode, press the Menu button [] to enter photo setting. Press the Shutter/Select button [] to cycle through the options within a setting. Use the Power/Mode button [] to cycle through the settings.

Mode: Photo mode contains four capture modes: Normal, Bust, Timer, Time Lapse capture.

 Normal	Captures a single photo.
 Burst	Enables you to take multiple images over a set number of seconds. Perfect for capturing the definitive moment in fast-action sports.
 Timer	Press the Shutter/Select button, camera begins count down and capture a picture within setting time.
 Time Lapse	Captures a series of photos at specific intervals.

Note: The Photo mode icon will appear in the upper left on your camera status screen.

Rate (only available in Bust mode): Set the number of photos taken every second, the available options are 3, 5, and 8 photos every second.

Timer (only available in Timer mode): Set the time of the timer, the options are 3s, 5s, 10s and 15s.

Interval (only available in Time Lapse mode): Time Lapse Photo lets your camera take photos at set time intervals, creating a video with stitched photos.

Res (Resolution): The maximum photo resolution is 8MP.

Shutter (Shutter Speed): Shutter speed lets you determine the amount of time that the shutter is open. The default option is Auto (Not support in burst mode).

Stamp: Add a date stamp to your photo.

Zoom: It zooms in on the center of the shot, good for capturing content at a distance, change the zoom value according to the distance between the camera and object.

Meter: The metering mode refers to the way in which the camera determines the exposure. Various metering modes are provided to allow the user to select the most appropriate one for use in a variety of lighting conditions.

WB (White Balance): White balance adjusts the overall color tone of photos. The camera can automatically adjust the white balance, or you can manually adjust the white balance.

Color: Color allows you to adjust the color profile of your photos.

ISO: ISO Limit adjusts the camera's sensitivity in low-light environments, and creates a balance between brightness and resulting image noise.





Sharpness: Sharpness controls the sharpness of your photos. You can use High option for an ultra-sharp look, the Medium option for moderate sharpness, or the Low option for a softer look.

EV: Exposure value (EV) affects the level of brightness of your photo. Adjusting this setting can improve image quality when shooting in environments with contrasting lighting conditions.

Calib(Calibration): It applies software correction to the lens distortion before it saves the image file to the memory card.

Setup Mode

Press the Power/Mode Button [] repeatedly until the Setup screen appears.

Press the Menu Button [] or Shutter/Select Button [] to enter the Settings Menu. Use the Power/Mode Button [] to cycle through the settings. To select an option, leave the option highlighted, press Shutter/Select Button [] to open the setting menu. To exit setting mode, press Menu Button [].

Quick Rec: With Quick Recording, you can quickly turn your camera on and begin capturing video or Time Lapse photos.

Wi-Fi: Turns On / Off Wi-Fi.

Wi-Fi: Set Wi-Fi working frequency. F1 supports 802.11a/b/g/n 2.4G/5GHz, which significantly improved anti-interference technology.

Bluetooth: Turns On / Off bluetooth.

System: Video format setting is mainly for watching the video on TV/HDTV to control the video frame rate of the recording.

Setting	Description
NTSC	Watch the video on the area of North America.
PAL	Watch the video on the PAL/HDTV (apply to the most of TV except the area of North America).

Def Mode(Default Mode): You can select the default capture mode that appears when the camera powers on. The options are Video and Photo mode.

OSD: The OSD (on-screen display) setting determine whether to display camera settings when displaying on other screens. The options for this setting are On (default) and Off.

LED: Set the status of the LED. The options are On and Off.

Flip: If you mount your camera upside down, you might have to rotate the files during editing. This setting eliminates the need to flip your video or photos after recording. The options for this setting are On and Off (Default).

Beeps: Turn On / Off the beeps.

Auto Off: Your camera can be configured to automatically power off after a specific period of time in which no videos or photos are captured and no buttons are pressed, you can also configure the camera to never automatically power off.

Time Setup: Setup the camera date and time manually.

Date: Select the date format.

Model Stamp: Display the camera model on your video. The options for this setting are On(default) and Off.

Ext Pwr:(External Power): Set the camera to go to the charging battery, power on or recording mode while the external charger connected.

Frequency: Set the camera's frequency to match the electrical frequency of your environment to reduce flicker.

Format: Format the SD card.

Default Setting: Reset camera to factory defaults.

Firmware Version: Display the current camera firmware version.

Connecting to the GitUp App

The GitUp App lets you control your camera remotely using a smartphone or tablet. Features include full camera control, live preview, playback and sharing of content.

To connect your F1 to the GitUp App:

1. Download the GitUp App to your smartphone / tablet from the Apple App Store or Google Play.
2. Follow the on-screen instructions to connect your camera to the App.

Note: the Wi-Fi SSID is GitUp_F1_XXXXXX and the default password for your camera is 1234567890.

Transferring Files to a Computer





To play back contents on your computer, copy the files to your computer first.

Note: Connect the camera to your computer using the USB cable. You can also transfer files to a computer using a card reader (sold separately). Connect the card reader to your computer and insert the microSD card into the reader. You can then transfer files to your computer or delete selected files on your card.

Playback on TV

Playing back videos and photos on your TV / HDTV requires a A/V out cable (sold separately).

To Play Back Content on a TV:

1. Plug the camera into a TV / HDTV with a A/V out cable, composite cable or combo cable.
2. Select the input on your TV that corresponds to the port into which you plugged the cable.
3. Power on the camera.
4. Press the Power/Mode button [] to cycle to Playback mode, and then press the Shutter/Select button [] to enter it.
5. Use the Power/Mode button [] to navigate file.
6. Use the Shutter/Select button [] to select file.
7. Use the menu button to open the file setting. The options for this setting are Video play on/all, Delete file, Return.
8. Use Power/Mode button [] to navigate backward and forward to see more media files on your memory card.

Battery

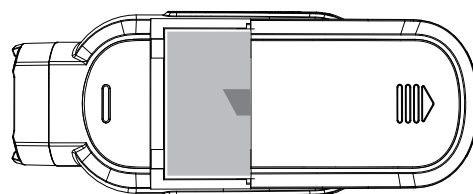

■ Charging the battery

Charging the battery by connecting the camera to a computer or other USB charging adapter using the included USB cable. The camera status light turns on during charging.

Note: Using wall chargers marked: output 5V 1A. If you don't know the voltage and current of your charger, use the included USB cable to charge the camera from your computer or a power bank.

■ Battery Storage and Handling

- Avoid exposing your camera and battery to very cold or very hot temperatures.
- Avoid dramatic changes in temperature or humidity when using the camera
- Do not dry the camera or battery with an external heat source such as a microwave oven or hair dryer when camera get wet.
- Do not store your battery with metal objects, such as coins, keys or necklaces

Package Included

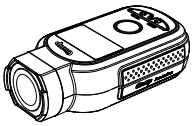

Action Camera F1

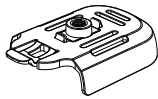

Mount



FPV Cable

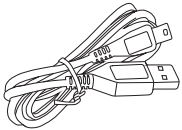

USB Data/Charging Cable

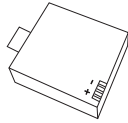

Battery

Optional Accessories

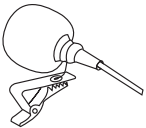

External Microphone

Customer Support

GitUp is dedicated to providing the best possible service. To reach GitUp Customer Support, please visit gitup.com.

Join GitUp Community



[Facebook.com/gitup.ltd](https://www.facebook.com/gitup.ltd)



[Youtube.com/gitup_com](https://www.youtube.com/gitup_com)



[Twitter.com/gitup_com](https://twitter.com/gitup_com)



[Instagram.com/gitup.world](https://www.instagram.com/gitup.world)