

AIR CONDITIONER

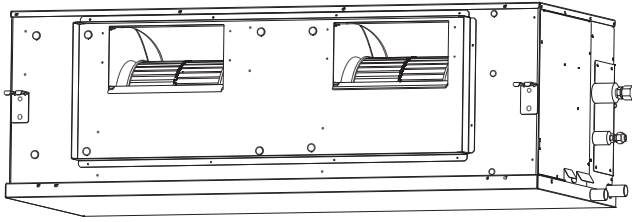

INSTALLATION MANUAL

INDOOR UNIT (Duct Type)
For authorized service personnel only.

English

INSTALLATIONSANLEITUNG

INNENGERÄT (Für Luftkanalsysteme)
Nur für autorisiertes Personal.

Deutsch

MANUEL D'INSTALLATION

UNITÉ INTÉRIEURE (Type conduit)
Pour le personnel agréé uniquement.

Français

MANUAL DE INSTALACIÓN

UNIDAD INTERIOR (Con conductos)
Solo para personal autorizado.

Español

MANUALE D'INSTALLAZIONE

UNITÀ INTERNA (Tipo di condotto)
Ad uso esclusivo del personale autorizzato.

Italiano

ΕΓΧΕΙΡΙΔΙΟ ΕΓΚΑΤΑΣΤΑΣΗΣ

ΕΣΩΤΕΡΙΚΗ ΜΟΝΑΔΑ (Τύπος αγωγού)
Για εξουσιοδοτημένο προσωπικό σέρβις.

Ελληνικά

MANUAL DE INSTALAÇÃO

UNIDADE INTERIOR (Tipo conduta)
Apenas para técnicos autorizados.

Português

РУКОВОДСТВО ПО УСТАНОВКЕ

ВНУТРЕННИЙ МОДУЛЬ (Канального типа)
Для уполномоченного персонала.

Русский

KURULUM KILAVUZU

İÇ ÜNİTE (Oluk tipi)
Yetkili servis personeli içindir.

Türkçe

Contents

1. SAFETY PRECAUTIONS	1
2. ABOUT THE UNIT	1
2.1. Precautions for using R410A refrigerant	1
2.2. Special tool for R410A	1
2.3. Accessories	2
2.4. Optional parts	2
3. INSTALLATION WORK	2
3.1. Selecting an installation location	2
3.2. Installation dimension	2
3.3. Installation the unit	3
4. PIPE INSTALLATION	4
4.1. Selecting the pipe material	4
4.2. Pipe requirement	4
4.3. Flare connection (pipe connection)	4
4.4. Installing heat insulation	5
5. INSTALLING DRAIN PIPES	5
6. ELECTRICAL WIRING	6
6.1. Electrical requirement	6
6.2. Wiring method	6
7. REMOTE CONTROLLER SETTING	7
7.1. Installing the remote controller	8
7.2. Setting the dip switches	8
8. FUNCTION SETTING	8
8.1. Turning on the power	8
8.2. Setting method	8
8.3. Function setting	9
8.4. Setting the room temperature detection location	10
9. TEST RUN	10
10. CHECK LIST	10
11. SPECIAL INSTALLATION METHODS	10
11.1. Group control system	10
11.2. Fan delay setting	11
11.3. Dual remote controllers	11
12. OPTIONAL PARTS	11
12.1. External input and external output	11
12.2. I.R. receiver unit / Remote sensor	12
13. CUSTOMER GUIDANCE	12
14. ERROR CODES	13

1. SAFETY PRECAUTIONS

- Be sure to read this Manual thoroughly before installation.
- The warnings and precautions indicated in this Manual contain important information pertaining to your safety. Be sure to observe them.
- Hand this Manual, together with the Operating Manual, to the customer. Request the customer to keep them on hand for future use, such as for relocating or repairing the unit.

 WARNING	This mark indicates procedures which, if improperly performed, might lead to the death or serious injury of the user.
Request your dealer or a professional installer to install the indoor unit in accordance with this Installation Manual. An improperly installed unit can cause serious accidents such as water leakage, electric shock, or fire. If the indoor unit is installed in disregard of the instructions in the Installation Manual, it will void the manufacturer's warranty.	
Do not turn ON the power until all work has been completed. Turning ON the power before the work is completed can cause serious accidents such as electric shock or fire.	
If refrigerant leaks while work is being carried out, ventilate the area. If the refrigerant comes in contact with a flame, it produces a toxic gas.	
Installation work must be performed in accordance with national wiring standards by authorized personnel only.	
Do not touch the fins of the heat exchanger. Touching the heat exchanger fins could result in damage to the fins or personal injury such as skin rupture.	

 CAUTION	This mark indicates procedures which, if improperly performed, might possibly result in personal harm to the user, or damage to property.
Read carefully all security information before use or install the air conditioner.	
Do not attempt to install the air conditioner or a part of the air conditioner by yourself.	
This unit must be installed by qualified personnel with a capacity certificate for handling refrigerant fluids. Refer to regulation and laws in use on installation place.	
The installation must be carried out in compliance with regulations in force in the place of installation and the installation instructions of the manufacturer.	
This unit is part of a set constituting an air conditioner. It must not be installed alone or with non-authorized by the manufacturer.	
Always use a separate power supply line protected by a circuit breaker operating on all wires with a distance between contact of 3 mm for this unit.	
The unit must be correctly grounded and the supply line must be equipped with a differential breaker in order to protect the persons.	

The units are not explosion proof and therefore should not be installed in explosive atmosphere.
Never touch electrical components immediately after the power supply has been turned off. Electric shock may occur. After turning off the power, always wait 5 minutes before touching electrical components.
This unit contains no user-serviceable parts. Always consult authorized service personnel to repairs.
When moving, consult authorized service personnel for disconnection and installation of the unit.
This appliance is not intended for use by persons (including children) with reduced physical, sensory or mental capabilities, or lack of experience and knowledge, unless they have been given supervision or instruction concerning use of the appliance by a person responsible for their safety. Children should be supervised to ensure that they do not play with the appliance.

2. ABOUT THE UNIT

2.1. Precautions for using R410A refrigerant

 WARNING
Do not introduce any substance other than the prescribed refrigerant into the refrigeration cycle. If air enters the refrigeration cycle, the pressure in the refrigeration cycle will become abnormally high and cause the piping to rupture.
If there is a refrigerant leak, make sure that it does not exceed the concentration limit. If a refrigerant leak exceeds the concentration limit, it can lead to accidents such as oxygen starvation.
Do not touch refrigerant that has leaked from the refrigerant pipe connections or other area. Touching the refrigerant directly can cause frostbite.
If a refrigerant leak occurs during operation, immediately vacate the premises and thoroughly ventilate the area. If the refrigerant comes in contact with a flame, it produces a toxic gas.

2.2. Special tool for R410A

 WARNING
To install a unit that uses R410A refrigerant, use dedicated tools and piping materials that have been manufactured specifically for R410A use. Because the pressure of R410A refrigerant is approximately 1.6 times higher than the R22, failure to use dedicated piping material or improper installation can cause rupture or injury. Furthermore, it can cause serious accidents such as water leakage, electric shock, or fire.

Tool name	Changes
Gauge manifold	The pressure in the refrigerant system is extremely high and cannot be measured with a conventional gauge. To prevent erroneous mixing of other refrigerants, the diameter of each port has been changed. It is recommended to use a gauge manifold with a high pressure display range of -0.1 to 5.3 MPa and a low pressure display range of -0.1 to 3.8 MPa.
Charging hose	To increase pressure resistance, the hose material and base size were changed. (The charging port thread diameter for R410A is 1/2 UNF 20 threads per inch.)
Vacuum pump	A conventional vacuum pump can be used by installing a vacuum pump adapter. Be sure that the pump oil does not backflow into the system. Use one capable for vacuum suction of -100.7 kPa (5 Torr, -755 mmHg).
Gas leakage detector	Special gas leakage detector for R410A refrigerant.

2.3. Accessories

⚠ WARNING

For installation purposes, be sure to use the parts supplied by the manufacturer or other prescribed parts.
The use of non-prescribed parts can cause serious accidents such as the unit falling, water leakage, electric shock, or fire.

- The following installation parts are furnished. Use them as required.
- Keep the Installation Manual in a safe place and do not discard any other accessories until the installation work has been completed.

Name and Shape	Q'ty	Description
Special nut A (Large flange)	4	For suspending the indoor unit from ceiling
Special nut A (small flange)	4	
Coupler heat insulation (Large)	1	For indoor side pipe joint (Gas pipe)
Coupler heat insulation (Small)	1	For indoor side pipe joint (Liquid pipe)
Cable tie (Large)	4	For fixing the heat insulation
Cable tie (Medium)	4	For fixing the remote controller cable and connection cable
Cable tie (Small)	1	For fixing the remote controller cable
Remote controller	1	For Air conditioner operation
Screw (Flush heads)	2	For installing indoor unit remote controller
Remote controller cable	1	For connecting the remote controller

2.4. Optional parts

Parts name	Model No.	Summary
Wired remote controller	UTY-RVN*M	For Air conditioner operation
Wired remote controller	UTY-RNN*M	For Air conditioner operation
Simple remote controller	UTY-RSN*M	For Air conditioner operation
Remote sensor	UTY-XSZX	New amenity space can be offered by installing the Remote sensor in the remote controller
External control set	UTD-ECS5A	Use to connect various peripheral devices and air conditioner PC board

3. INSTALLATION WORK

Especially, the installation place is very important for the split type air conditioner because it is very difficult to move from place to place after the first installation.

3.1. Selecting an installation location

Decide the mounting position together with the customer as follows.

⚠ WARNING

Select installation locations that can properly support the weight of the indoor unit. Install the units securely so that they do not topple or fall.

⚠ CAUTION

Do not install the indoor unit in the following areas:

- Area with high salt content, such as at the seaside.
It will deteriorate metal parts, causing the parts to fall or the unit to leak water.
- Area filled with mineral oil or containing a large amount of splashed oil or steam, such as a kitchen.
It will deteriorate plastic parts, causing the parts to fall or the unit to leak water.
- Area that generates substances that adversely affect the equipment, such as sulfuric gas, chlorine gas, acid, or alkali. It will cause the copper pipes and brazed joints to corrode, which can cause refrigerant leakage.
- Area that can cause combustible gas to leak, contains suspended carbon fibers or flammable dust, or volatile inflammables such as paint thinner or gasoline. If gas leaks and settles around the unit, it can cause a fire.
- Area where animals may urinate on the unit or ammonia may be generated.

Do not use the unit for special purposes, such as storing food, raising animals, growing plants, or preserving precision devices or art objects. It can degrade the quality of the preserved or stored objects.

Do not install where there is the danger of combustible gas leakage.

Do not install the unit near a source of heat, steam, or flammable gas.

Install the unit where drainage does not cause any trouble.

Install the indoor unit, outdoor unit, power supply cable, transmission cable, and remote control cable at least 1 m away from a television or radio receivers. The purpose of this is to prevent TV reception interference or radio noise.
(Even if they are installed more than 1 m apart, you could still receive noise under some signal conditions.)

Install the unit where ambient temperature does not reach 60°C or more.

Take a measure such as ventilation for an environment in which heat is retained.

If children under 10 years old may approach the unit, take preventive measures so that they cannot reach the unit.

Take precautions to prevent the unit from falling.

- Install the indoor unit on a place having a sufficient strength so that it withstands against the weight of the indoor unit.
- The inlet and outlet ports should not be obstructed; the air should be able to blow all over the room.
- Leave the space required to service the air conditioner.
- Install the unit where connection to the outdoor unit is easy.
- Install the unit where the connection pipe can be easily installed.
- Install the unit where the drain pipe can be easily installed.
- Install the unit where noise and vibrations are not amplified.
- Take servicing, etc., into consideration and leave the spaces. Also install the unit where the filter can be removed.
- Do not install the unit where it will be exposed to direct sunlight.

3.2. Installation dimension

3.2.1. Installation by which service space is made on top of the unit (recommended)

Install the unit away from the ceiling by 350 mm or more.

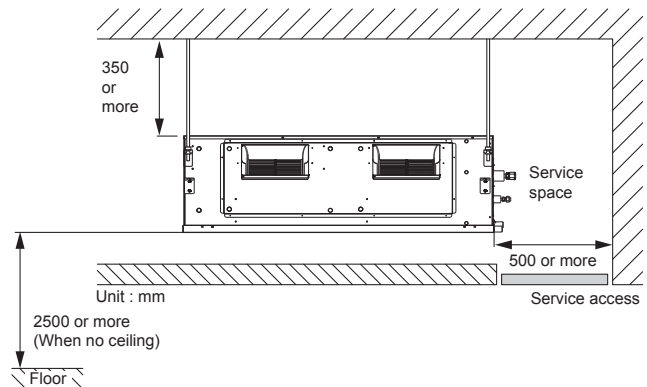

3.2.2. Installation by which service is carried out from the bottom of the unit

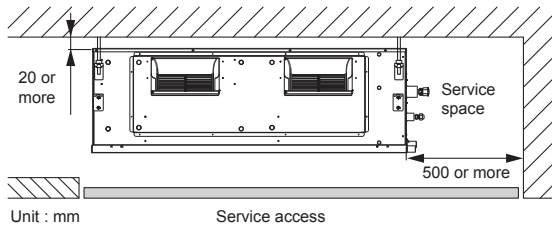

3.2.3. (For maintenance)

- (1) Maintenance work of the control box is possible with the Service access of the measurement shown in the figure.
- (2) If maintenance work is to be done from the bottom side, the Service access needs to be larger than the outside dimension of the indoor unit.
- (3) If maintenance work is to be done from the top, keep the space of the more than 450 mm between the indoor unit and ceiling.

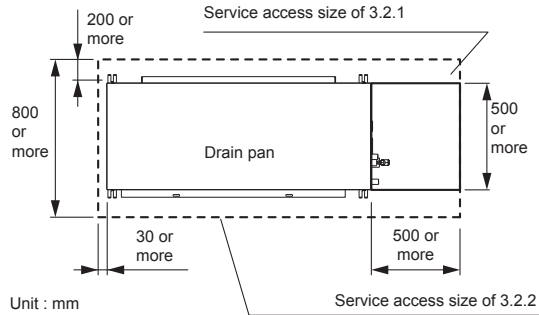

3.3. Installation the unit

⚠ WARNING

Install the air conditioner in a location which can withstand a load of at least 5 times the weight of the main unit and which will not amplify sound or vibration. If the installation location is not strong enough, the indoor unit may fall and cause injuries.

If the job is done with the panel frame only, there is a risk that the unit will come loose. Please take care.

Carrying in and installation of the unit should be performed by a sufficient number of people and with sufficient equipment that is adequate for the weight of the unit. Performing such work by an insufficient number of people or with inadequate equipment could result in dropping of the unit or personal injury.

⚠ CAUTION

Confirm the directions of the air intake and outlet before installing the unit. The unit takes in air from the evaporator side, and expels it from the fan side.

For installation, refer to the technical data.

3.3.1. Conveyance method

- Leave the packing materials on until the unit is at the installation site.
 - Remove the packing hardware and dispose of it.
 - Be careful not to dispose the accessories.
- Unit is packed upside down.

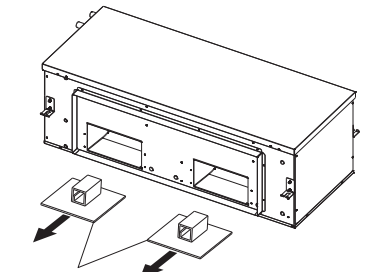

Fan holder (2 locations) Pull them out towards you.

3.3.2. Installing hangers

Suspend the indoor unit by referring to the following figures.

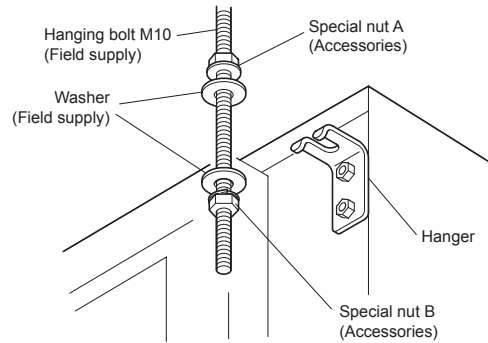
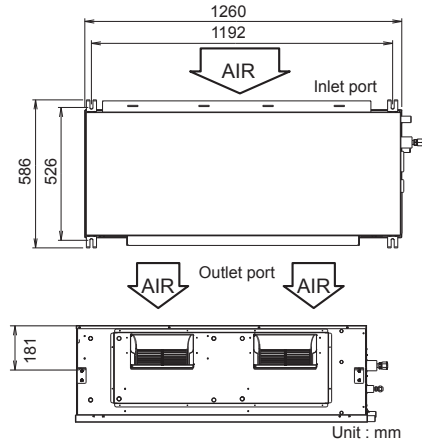

⚠ CAUTION

Fasten the unit securely with special nuts A and B.

3.3.3. Leveling

Use the procedure in the following figure to adjust the levelness.

(Front)

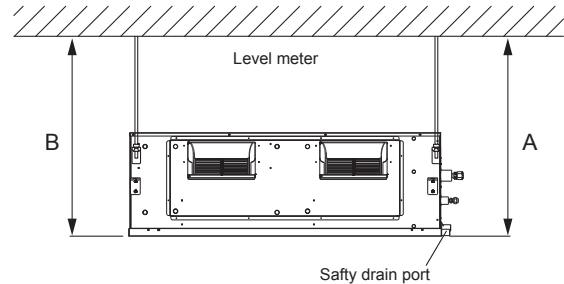

The side of the unit that holds the drain port A should be slightly lower than the opposite side of the unit B. The slant should allow from 0 to 20 mm of difference between A and B.

(Side)

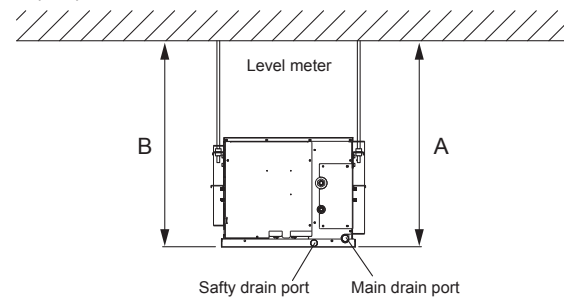

The side of the unit that holds the drain port A should be slightly lower than the opposite side of the unit B. The slant should allow from 0 to 10 mm of difference between A and B.

3.3.4. Mounting the duct

Follow the procedure in the following figure to install the ducts.

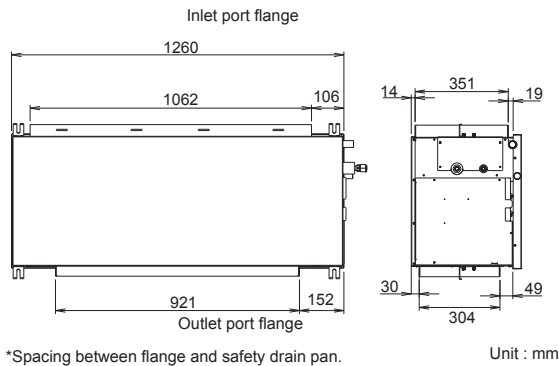

*Spacing between flange and safety drain pan.

Unit : mm

CAUTION

To prevent people from touching the parts inside the unit, be sure to install grilles on the inlet and outlet ports. The grilles must be designed in such a way that cannot be removed without tools.

Set the external static pressure between 60 and 260Pa and set the appropriate static pressure mode. (Refer to 8.3 Function setting)

If an intake duct is installed, take care not to damage the temperature sensor (the temperature sensor is attached to the intake port flange).

Install the air inlet grille for air circulation. The correct temperature can not be detected.

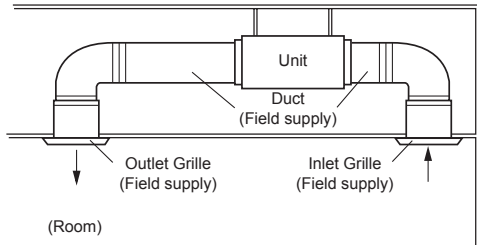

When connecting the duct, perform duct-insulation that is appropriate for the installing environment. Inappropriate insulation work may cause condensation on the surface of the insulating material, and may lead condensation drip.

4. PIPE INSTALLATION

CAUTION

Be more careful that foreign matter (oil, water, etc.) does not enter the piping than with refrigerant R410A models. Also, when storing the piping, securely seal the openings by pinching, taping, etc.

While welding the pipes, be sure to blow dry nitrogen gas through them.

4.1. Selecting the pipe material

CAUTION

Do not use existing pipes.

Use pipes that have clean external and internal sides without any contamination which may cause trouble during use, such as sulfur, oxide, dust, cutting waste, oil, or water.

It is necessary to use seamless copper pipes.
Material : Phosphor deoxidized seamless copper pipes
It is desirable that the amount of residual oil is less than 40 mg/10 m.

Do not use copper pipes that have a collapsed, deformed, or discolored portion (especially on the interior surface). Otherwise, the expansion valve or capillary tube may become blocked with contaminants.

Improper pipe selection will degrade performance. As an air conditioner using R410A incurs pressure higher than when using conventional refrigerant, it is necessary to choose adequate materials.

- Thicknesses of copper pipes used with R410A are as shown in the table.
- Never use copper pipes thinner than those indicated in the table even if they are available on the market.

Pipe outside diameter [mm (in.)]	Thickness [mm]
6.35 (1/4)	0.8
9.52 (3/8)	0.8
12.70 (1/2)	0.8
15.88 (5/8)	1.0
19.05 (3/4)	1.2

4.2. Pipe requirement

CAUTION

Refer to the Installation Manual of the outdoor unit for description of the length of connecting pipe or for difference of its elevation.

Diameter [mm (in.)]	Liquid	9.52 (3/8)
	Gas	15.88 (5/8)

- Use pipe with water-resistant heat insulation.

CAUTION

Install heat insulation around both the gas and liquid pipes. Failure to do so may cause water leaks.
Use heat insulation with heat resistance above 120 °C. (Reverse cycle model only)
In addition, if the humidity level at the installation location of the refrigerant piping is expected to exceed 70 %, install heat insulation around the refrigerant piping.
If the expected humidity level is 70-80 %, use heat insulation that is 15 mm or thicker and if the expected humidity exceeds 80 %, use heat insulation that is 20 mm or thicker. If heat insulation is used that is not as thick as specified, condensation may form on the surface of the insulation.
In addition, use heat insulation with heat conductivity of 0.045 W/(m·K) or less (at 20 °C).

4.3. Flare connection (pipe connection)

4.3.1. Flaring

- Use special pipe cutter and flare tool exclusive for R410A.
- (1) Cut the connection pipe to the necessary length with a pipe cutter.
 - (2) Hold the pipe downward so that cuttings will not enter the pipe and remove any burrs.
 - (3) Insert the flare nut (always use the flare nut attached to the indoor and outdoor units respectively) onto the pipe and perform the flare processing with a flare tool. Use the special R410A flare tool, or the conventional flare tool. Leakage of refrigerant may result if other flare nuts are used.
 - (4) Protect the pipes by pinching them or with tape to prevent dust, dirt, or water from entering the pipes.

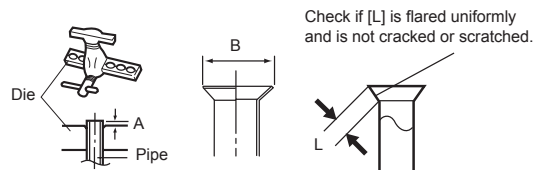

Pipe outside diameter [mm (in.)]	Dimension A [mm]	Dimension B _{±0.4} [mm]
	Flare tool for R410A, clutch type	
6.35 (1/4)	0 to 0.5	9.1
9.52 (3/8)		13.2
12.70 (1/2)		16.6
15.88 (5/8)		19.7
19.05 (3/4)		24.0

When using conventional flare tools to flare R410A pipes, the dimension A should be approximately 0.5 mm more than indicated in the table (for flaring with R410A flare tools) to achieve the specified flaring. Use a thickness gauge to measure the dimension A.

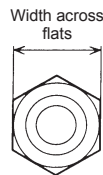

Pipe outside diameter [mm (in.)]	Width across flats of Flare nut [mm]
6.35 (1/4)	17
9.52 (3/8)	22
12.70 (1/2)	26
15.88 (5/8)	29
19.05 (3/4)	36

4.3.2. Bending pipes

- If pipes are shaped by hand, be careful not to collapse them.
- Do not bend the pipes in an angle more than 90°.
- When pipes are repeatedly bend or stretched, the material will harden, making it difficult to bend or stretch them any more.
- Do not bend or stretch the pipes more than 3 times.

⚠ CAUTION
To prevent breaking of the pipe, avoid sharp bends.
If the pipe is bent repeatedly at the same place, it will break.

4.3.3. Pipe connection

⚠ CAUTION
Be sure to apply the pipe against the port on the indoor unit correctly. If the centering is improper, the flare nut cannot be tightened smoothly. If the flare nut is forced to turn, the threads will be damaged.
Do not remove the flare nut from the indoor unit pipe until immediately before connecting the connection pipe.
Do not use mineral oil on flared part. Prevent mineral oil from getting into the system as this would reduce the lifetime of the units.

- (1) Detach the caps and plugs from the pipes.
- (2) Centering the pipe against port on the indoor unit, turn the flare nut with your hand.

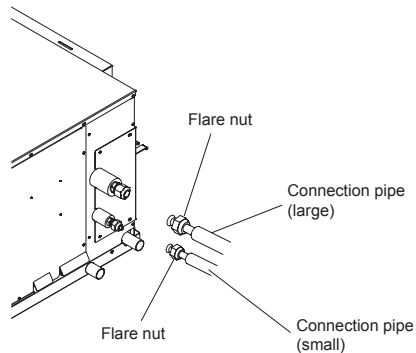

- (3) When the flare nut is tightened properly by your hand, hold the body side coupling with a separate spanner, then tighten with a torque wrench. (See the table below for the flare nut tightening torques.)

⚠ CAUTION
Hold the torque wrench at its grip, keeping it in the right angle with the pipe, in order to tighten the flare nut correctly.
Tighten the flare nuts with a torque wrench using the specified tightening method. Otherwise, the flare nuts could break after a prolonged period, causing refrigerant to leak and generate a hazardous gas if the refrigerant comes into contact with a flame.

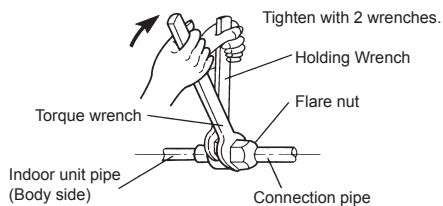

Flare nut [mm (in.)]	Tightening torque [N·m (kgf·cm)]
6.35 (1/4) dia.	16 to 18 (160 to 180)
9.52 (3/8) dia.	32 to 42 (320 to 420)
12.70 (1/2) dia.	49 to 61 (490 to 610)
15.88 (5/8) dia.	63 to 75 (630 to 750)
19.05 (3/4) dia.	90 to 110 (900 to 1,100)

4.4. Installing heat insulation

Install the heat insulation material after performing a refrigerant leak check (see the Installation Manual for the outdoor unit for details).

4.4.1. COUPLER HEAT INSULATION

- Insulate with the coupler heat insulation (Accessories) around the gas pipe and liquid pipe at indoor unit.
- After installing the coupler heat insulation, wrap both ends with vinyl tape so that there is no gap.
- After affixing the coupler heat insulation, secure it with 2 cable tie (large), one on each end of the insulation.
- Make sure that the cable tie overlap the heat insulation pipe.

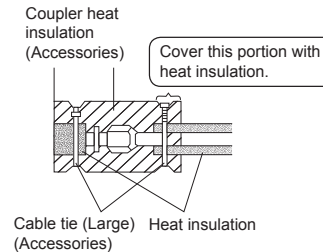

⚠ CAUTION
After checking for gas leaks (refer to the Installation Manual of the outdoor unit), perform this section.
Install heat insulation around both the large (gas) and small (liquid) pipes. Failure to do so may cause water leaks.

5. INSTALLING DRAIN PIPES

⚠ CAUTION
Install the drain pipe in accordance with the instructions in this Installation Manual and keep the area warm enough to prevent condensation. Problems with the piping may lead to water leaks.
This UNIT has drain ports in 2 locations. Follow the procedure in the figure to connect drain pipes to each of them.
Be sure to properly insulate the drain pipes.
The position of the installed drain pipe should have a downward gradient of 1/100 or more.
Do not connect the drain pipe in which ammonia or other types of gas affecting the unit is generated.

Install the drain pipes according to the measurements given in the following figure. Flange positions for connecting the drain pipes

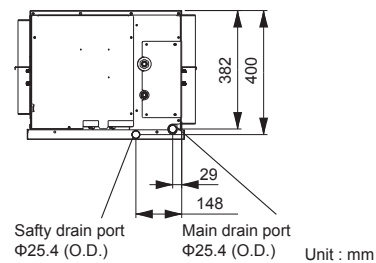

• INSTALL THE DRAIN PIPE

Use general hard polyvinyl chloride pipe (VP25) and connect it with adhesive (polyvinyl chloride) so that there is no leakage. Do not perform air bleeding.

- (1) Main drain pipe
Provide one trap on the main drain pipe near the indoor unit.

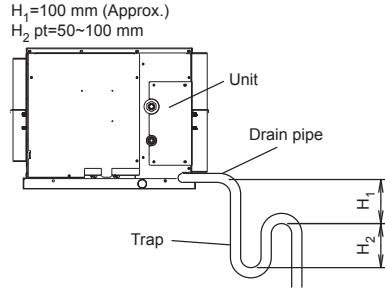

- (2) Safety drain
There is no need to provide a trap for the safety drain pipe. If the safety drain pipe is connected to the main drain pipe, make the connection below the trap on the main drain pipe

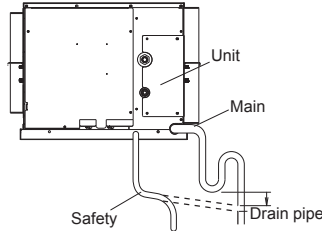

- Make sure that drain pipe is installed without rises.
- Do not perform air bleeding.

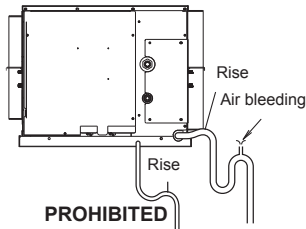

CAUTION
Make sure the drain water is properly drained.

6. ELECTRICAL WIRING

WARNING
Electrical work must be performed in accordance with this Manual by a person certified under the national or regional regulations. Be sure to use a dedicated circuit for the unit. An insufficient power supply circuit or improperly performed electrical work can cause serious accidents such as electric shock or fire.
Before starting work, check that power is not being supplied to the indoor unit and outdoor unit.
Use the included connection cables and power cables or ones specified by the manufacturer. Improper connections, insufficient insulation, or exceeding the allowable current can cause electric shock or fire.
For wiring, use the prescribed type of cables, connect them securely, making sure that there are no external forces of the cables applied to the terminal connections. Improperly connected or secured cables can cause serious accidents such as overheating the terminals, electric shock, or fire.
Do not modify the power cables, use extension cables, or use any branches in the wiring. Improper connections, insufficient insulation, or exceeding the allowable current can cause electric shock or fire.
Match the terminal board numbers and connection cable colors with those of the outdoor unit. Erroneous wiring may cause burning of the electric parts.
Securely connect the connection cables to the terminal board. In addition, secure the cables with wiring holders. Improper connections, either in the wiring or at the ends of the wiring, can cause a malfunction, electric shock, or fire.
Always fasten the outside covering of the connection cable with the cable clamp. (If the insulator is chafed, electric leakage may occur.)
Securely install the electrical box cover on the unit. An improperly installed electrical box cover can cause serious accidents such as electric shock or fire through exposure to dust or water.
Install sleeves into any holes made in the walls for wiring. Otherwise, a short circuit could result.
Install a ground leakage breaker. In addition, install the ground leakage breaker so that the entire AC main power supply is cut off at the same time. Otherwise, electric shock or fire could result.
Install a ground leakage breaker. If a ground leakage breaker is not installed, it may cause electric shock or fire.
Always connect the earth (ground) cable. Improper earthing (grounding) work can cause electric shocks.
Install the remote control cables so as not to be direct touched with your hand.

WARNING
Perform wiring work in accordance with standards so that the air conditioner can be operated safely and positively.
Connect the connection cable firmly to the terminal board. Imperfect installation may cause a fire.

CAUTION
Ground the unit.
Do not connect the earth (ground) cable to a gas pipe, water pipe, lightning rod, or a telephone earth (ground) cable.
Improper earthing (grounding) may cause electric shock.
Do not connect power supply cables to the transmission or remote control terminals, as this will damage the product.
Never bundle the power supply cable and transmission cable together. Bundling these cables together will cause miss operation.
When handling PCB, static electricity charged in the body may cause malfunction of the PCB. Follow the cautions below:
• Establish a ground for the indoor and outdoor units and peripheral devices.
• Cut power (breaker) off.
• Touch metal part of the indoor and outdoor units for more than 10 seconds to discharge static electricity charged in the body.
• Do not touch terminals of parts and patterns implemented on PCB.

6. 1. Electrical requirement

Cable	Cable size (mm ²)	Type	Remarks
Connection cable	1.5 (MIN.)	Type 60245 IEC57	3Cable+Earth (Ground), 1φ230V

- Max. Cable Length: Limit voltage drop to less than 2%. Increase cable gauge if voltage drop is 2% or more.
• Perform all electrical work according to the standard.
• Install circuit breakers, which have the terminal spacing of more than 3 mm, in a place of near the indoor unit and outdoor unit.

CAUTION
Be sure to execute the electrical work according to the Laws of each country and the Installation Instructions. In addition, be sure to set as exclusive line and use the rated voltage and circuit breaker.

6. 2. Wiring method

6. 2. 1. Connection diagrams

- Connection cable (to outdoor unit)

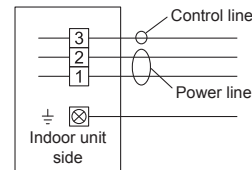

- Wired remote controller cable

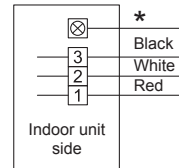

*Ground the remote controller if it has a earth (ground) wire.

6.2.2. Connection cable preparation

Keep the earth (ground) wire longer than the other wires.

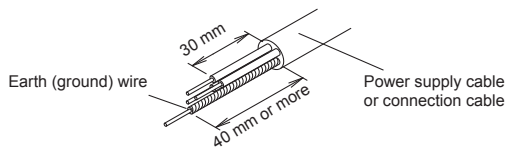

• Use a 4-core wire cable.

How to connect wiring to the terminals. (For strand wiring)

- Use crimp-type terminals with insulating sleeves as shown in the figure below to connect to the terminal block.
- Securely crimp the crimp-type terminals to the wires using an appropriate tool so that the wires do not come loose.

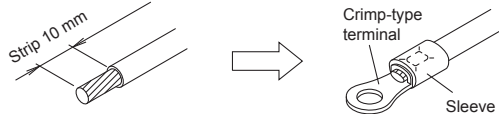

- Use the specified wires, connect them securely, and fasten them so that there is no stress placed on the terminals.
- Use an appropriate screwdriver to tighten the terminal screws. Do not use a screwdriver that is too small, otherwise, the screw heads may be damaged and prevent the screws from being properly tightened.
- Do not tighten the terminal screws too much, otherwise, the screws may break.
- See the table below for the terminal screw tightening torques.

WARNING

Use crimp-type terminals and tighten the terminal screws to the specified torques, otherwise, abnormal overheating may be produced and possibly cause serious damage inside the unit.

Tightening torque [N·m (kgf·cm)]

M4 screw	1.2 to 1.8 (12 to 18)
M5 screw	2.0 to 3.0 (20 to 30)

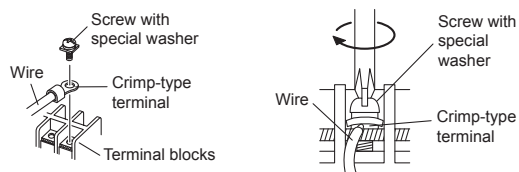

6.2.3. Connection wiring

CAUTION

Use care not to mistake the power supply cable and connection wires when installing.
Install so that the wires for the remote controller will not come in contact with other connection wires.

- Remove the control box cover and install each connection wire.

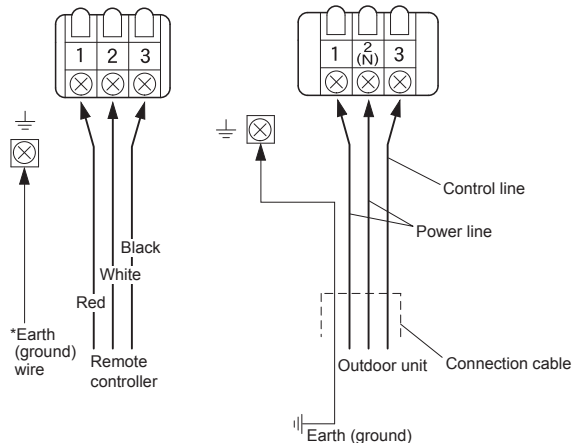
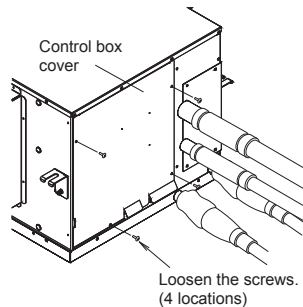

*Ground the remote controller if it has a earth (ground) wire.

- After wiring is complete, secure the remote controller cable, connection cable, and power supply cable with the cable clamps.

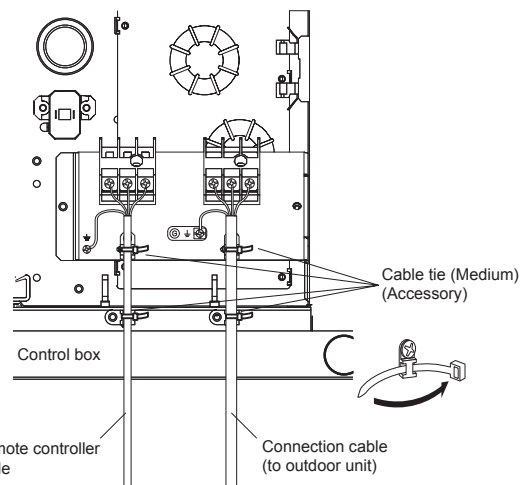

- Seal the cable outlet or other gaps with putty to prevent dew condensation or insect from entering the electric control box.
- Install the control box cover.

CAUTION

Do not bundle the remote controller cable, or wire the remote controller cable in parallel, with the indoor unit connection wire (to the outdoor unit) and the power supply cable. It may cause erroneous operation.

7. REMOTE CONTROLLER SETTING

CAUTION

When using the temperature sensor of remote controller, be sure to meet the following location requirements for installation of the remote controller in order to detect the room temperature correctly. If the remote controller is installed in an improper location, troubles such as "the room does not become cool or warm" may occur even though there is no problem in the air conditioner.

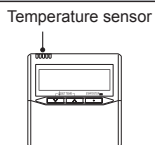

- A location where the average room temperature can be detected.
- A location that is not directly exposed to the air blown out of the indoor unit.
- A location that is not exposed to direct sunlight.
- A location that is not affected by any heat source.

Do not touch the remote controller PC board and PC board parts directly with your hands.

Install the remote controller wires so as not to be direct touched with your hand.

Do not wire the remote controller cable and the bus wire together with or parallel to the connection cables, transmission cables, and power supply cables of the indoor and outdoor units. It may cause erroneous operation.

When installing the bus wire near a source of electromagnetic waves, use shielded wire.

Do not set the DIP switches, either on the air conditioner or the remote controller, in any way other than indicated in this manual or the manual that is supplied with the air conditioner. Doing so may result in an accident.

7.1. Installing the remote controller

Open the operation panel on the front of the remote controller, remove the 2 screws indicated in the following figure, and then remove the front case of the remote controller. When installing the remote controller, remove the connector from the front case. The wires may break if the connector is not removed and the front case hangs down. When installing the front case, connect the connector to the front case.

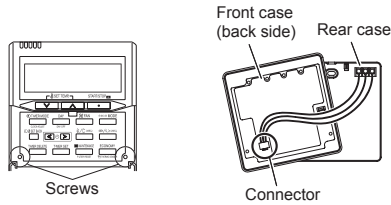

- When remote controller cable is embedded
- (1) Embed the remote controller cable and box.
 - (2) Pass the remote controller cable through the hole in the rear case and connect the remote controller cable to the remote controller terminal blocks specified in figure.
 - (3) Clamp the remote controller cable sheath with the cable tie as shown in figure.
 - (4) Cut off the excess cable tie.
 - (5) Install the rear case to the wall, box, etc., with 2 screws figure.

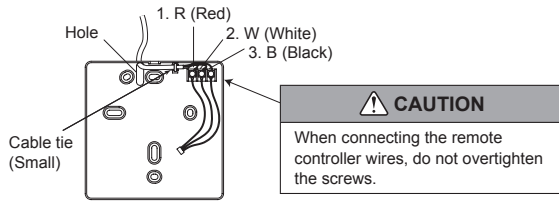

Seal the cable outlet with putty to prevent dew condensation or insect from entering the box.

• [Example]

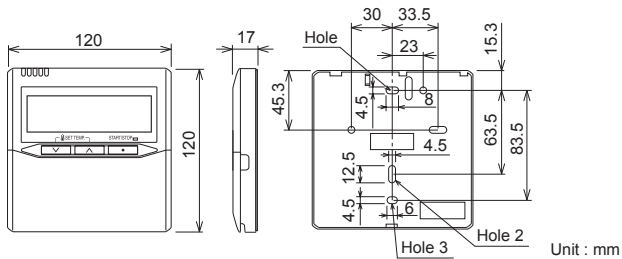
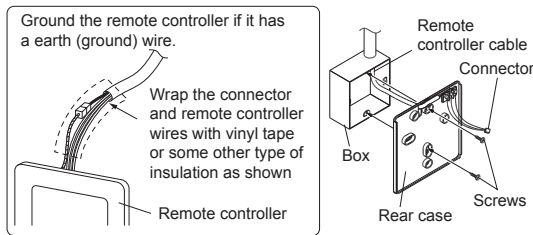

7.2. Setting the dip switches

Set the remote controller DIP switches.

[Example]

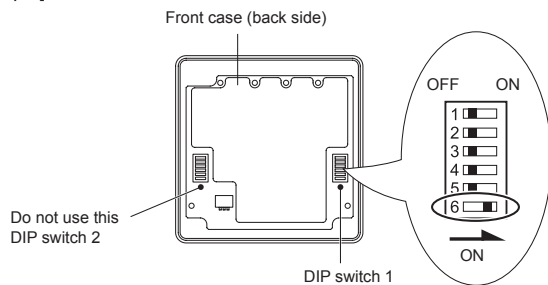

No.	SW state		Detail
	OFF	ON	
1	◆		Cannot be used. (Do not change)
2	◆		Dual remote controller setting *Refer to 11.3. Dual remote controllers
3	◆		Cannot be used. (Do not change)
4	◆		Cannot be used. (Do not change)
5	◆		Cannot be used. (Do not change)
6	◆	Validity	Memory backup setting *Set to ON to use batteries for the memory backup. If batteries are not used, all of the settings stored in memory will be deleted if there is a power failure.

(◆ : Factory setting)

8. FUNCTION SETTING

CAUTION

Confirm whether the wiring work for outdoor unit has been finished.

Confirm whether the cover for electric control box on the outdoor unit is close.

8.1. Turning on the power

- (1) Check the remote controller wiring and DIP switch settings.
 - (2) Install the front case. When installing the front case, connect the connector to the front case.
 - (3) Check the indoor and outdoor unit wiring and circuit board switch settings, and then turn on the indoor and outdoor units. After "9C" has flashed on the set temperature display for several seconds, the clock display will appear in the center of the remote controller display.
- The clock display will appear in the center of the remote controller display.



8.2. Setting method

- This procedure changes to the function settings used to control the indoor unit according to the installation conditions.
 - Incorrect settings can cause the indoor unit malfunction.
 - After the power is turned on, perform the "FUNCTION SETTING" according to the installation conditions using the remote controller.
 - The settings may be selected between the following two:
 - Function Number or Setting Value.
 - Settings will not be changed if invalid numbers or setting values are selected.
- (1) Press the set temperature buttons (▽) (△) and fan control button simultaneously for more than 5 seconds to enter the function setting mode.

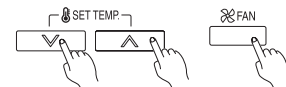

Press the SET BACK button to select the indoor R.C. address.



R.C. address of INDOOR UNIT

- (2) Press the set time buttons to select the function number.

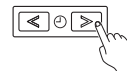

Function number

- (3) Press the set temperature buttons (▼) (▲) to select the setting value.
The display flashes as shown to the right during setting value selection.

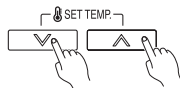

- (4) Press the TIMER SET button to confirm the setting. Press the TIMER SET button for a few seconds until the setting value stops flashing.
If the setting value display changes or if "- -" is displayed when the flashing stops, the setting value has not been set correctly. (An invalid setting value may have been selected for the indoor unit.)



Setting value

- (5) Repeat steps 2 to 5 to perform additional settings. Press the set temperature buttons (▼) (▲) and fan control button simultaneously again for more than 5 seconds to cancel the function setting mode. In addition, the function setting mode will be automatically canceled after 1 minute if no operation is performed.
(6) After completing the FUNCTION SETTING, be sure to turn off the power and turn it on again.

CAUTION

After turning off the power, wait 30 seconds or more before turning it on again. The FUNCTION SETTING doesn't become effective if it doesn't do so.

8.3. Function setting

Filter Sign

- The indoor unit has a sign to inform the user that it is time to clean the filter. Select the time setting for the filter sign display interval in the table below according to the amount of dust or debris in the room. If you do not wish the filter sign to be displayed, select the setting value for "No indication".
(The unit is factory-set to "03".)

Setting Description	Function Number	Setting Value
Standard (2500 hours)	11	00
Long interval (5000 hours)		01
Short interval (1250 hours)		02
No indication		03

Setting the Static Pressure

- Select appropriate static pressure according to the installation conditions.
(The unit is factory-set to "00".)
- Refer to the technical manual for details or follow the instructions of the duct designer.

Setting Description	Function Number	Setting Value
Normal (60Pa)	21	00
static pressure 1 (100Pa)		02
static pressure 2 (150Pa)		03
static pressure 3 (200Pa)		04
static pressure 4 (250Pa)		05

Setting the Cooler Room Temperature Correction

- Depending on the installed environment, the room temperature sensor may require a correction. The settings may be selected as shown in the table below.
(The unit is factory-set to "00".)

Setting Description	Function Number	Setting Value
Standard (No correction)	30	00
Low control (-1.0°C)		01
Slightly lower control (-0.5°C)		02
Slightly warmer control (+0.5°C)		03
Warmer control (+1.0°C)		04

Setting the Heater Room Temperature Correction

- Depending on the installed environment, the room temperature sensor may require a correction. The settings may be selected as shown in the table below.
(The unit is factory-set to "00".)

Setting Description	Function Number	Setting Value
Standard (No correction)	31	00
Low control (-1.0°C)		01
Slightly lower control (-0.5°C)		02
Slightly warmer control (+0.5°C)		03
Warmer control (+1.0°C)		04

Auto Restart

(The setting value is factory-set to "00".)

Setting Description	Function Number	Setting Value
Yes	40	00
No		01

Indoor Room Temperature Sensor Switching Function

(Wired remote controller only)

(The setting value is factory-set to "00".)

Setting Description	Function Number	Setting Value
Only the sensor of the indoor unit is used	42	00
The sensor of the wired remote controller is used		01

Cool Air Prevention

- This setting is used to set the fan speed when the compressor stops once the room temperature has reached the set temperature during heating operation.
(The unit is factory-set to "00".)

Setting Description	Function Number	Setting Value
Super low	43	00
Follow the setting on the remote controller (corresponding to ventilation)		01

External input control

- "Operation/Stop" mode or "Forced stop" mode can be selected.
(The unit is factory-set to "00".)

Setting Description	Function Number	Setting Value
Operation/Stop mode	46	00
(Setting forbidden)		01
Forced stop mode		02

Room Temperature Control Switching

- This setting is used to set the room temperature control method when the wired remote controller is selected by the Indoor Room Temperature Sensor Switching Function.
(The unit is factory-set to "00".)

Setting Description	Function Number	Setting Value
Control by the sensors of both the indoor unit and the wired remote controller.	48	00
Control only by the sensor of the wired remote controller.		01

Setting record

Record any changes to the settings in the following table.

Jumper wire	Setting Value
Filter Sign	
Static Pressure	
Cooler Room Temperature Correction	
Heater Room Temperature Correction	
Auto Restart	
Room Temperature Sensor Switching	
Cool Air Prevention	
External input control	
Room Temperature Control Switching	

- After completing the FUNCTION SETTING, be sure to turn off the power and turn it on again.

8.4. Setting the room temperature detection location

- The detection location of the room temperature can be selected from the following two examples. Choose the detection location that is best for the installation location.

A. Indoor unit setting (factory setting)

- The room temperature is detected by the indoor unit temperature sensor.
- (1) When the THERMO SENSOR button is pressed, the lock display flashes because the function is locked at the factory.

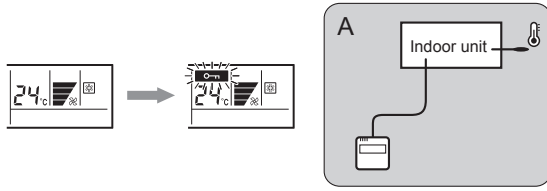

B. Indoor unit/remote controller setting (room temperature sensor selection)

The temperature sensor of the indoor unit or the remote controller can be used to detect the room temperature.

- Enable the room temperature sensor selection in FUNCTION SETTING, which will be described later.
- Press the THERMO SENSOR button for 5 seconds or more to select the temperature sensor of the indoor unit or the remote controller.

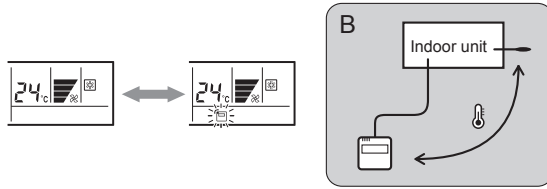

NOTE

If the function to change the temperature sensor is used as shown in examples A (other than example B), be sure to lock the detection location.

If the function is locked, the lock display  will flash when the THERMO SENSOR button is pressed.

CAUTION

If the difference between the room temperature and wall temperature is great as the external and internal walls are joined and the wall temperature is easily affected by the outside air, the detected temperature may be different from the actual room temperature because the sensor of the remote controller detects the temperature near the wall surface. Especially when the remote controller is installed on a wall that is directly exposed to the outside air, it is recommended to use the indoor unit temperature sensor.

Do not use the temperature sensor of the remote controller as a substitute for the indoor unit temperature sensor which has problem in the temperature detection. (Solve the problem of the indoor unit temperature sensor.)

If the unit is installed in a room with a ceiling of 3 m or higher, the temperature may not be detected properly with the indoor unit temperature sensor as there may be a large difference between the temperature near the ceiling and the floor. In this case, it is recommended to take a measure such as installation of an optional remote sensor and room air ventilation using a circulator.

9. TEST RUN

CHECK ITEMS

- Is operation of each button on the remote control unit normal?
- Is the drain normal?
- Is there any abnormal noise and vibration during operation?
- Do not operate the air conditioner in the running state for a long time.

[Operation method]

For the operation method, refer to the Operating Manual.

- Stop the air conditioner operation.
- Press the MODE button and the FAN button simultaneously for 2 seconds or more to start the test run.

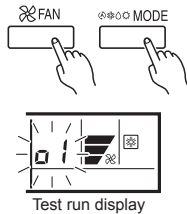

- Press the START/STOP button to stop the test run. If "C0" appears in the R.C. address display, there is a remote controller error.

R.C. address	Error code	Content
C0	15	Incompatible indoor unit is connected
C0	12	Indoor unit ↔ remote controller communication error

10. CHECK LIST

Pay special attention to the check items below when installing the indoor unit(s). After installation is complete, be sure to check the following check items again.

Check items	If not performed correctly	Check box
Has the indoor unit been installed correctly?	Vibration, noise, indoor unit may drop	<input type="checkbox"/>
Has there been a check for gas leaks (refrigerant pipes)?	No cooling, No heating	<input type="checkbox"/>
Has heat insulation work been completed?	Water leakage	<input type="checkbox"/>
Does water drain easily from the indoor units?	Water leakage	<input type="checkbox"/>
Is the voltage of the power source the same as that indicated on the label on the indoor unit?	No operation, heat or burn damage	<input type="checkbox"/>
Are the wires and pipes all connected completely?	No operation, heat or burn damage	<input type="checkbox"/>
Is the indoor unit grounded?	Short circuit	<input type="checkbox"/>
Is the connection cable the specified thickness?	No operation, heat or burn damage	<input type="checkbox"/>
Are the inlets and outlets free of any obstacles?	No cooling, No heating	<input type="checkbox"/>
After installation is completed, has the proper operation and handling been explained to the user?	_____	<input type="checkbox"/>
Operate the unit according to the operating manual provided, and check that it is operating normally.	_____	<input type="checkbox"/>

11. SPECIAL INSTALLATION METHODS

CAUTION

Be sure to turn off the electrical breaker before making settings.

When setting DIP switches, do not touch any other parts on the circuit board directly with your bare hands.

11.1. Group control system

A number of indoor units can be operated at the same time using a single remote controller.

- Wiring method (indoor unit to remote controller)

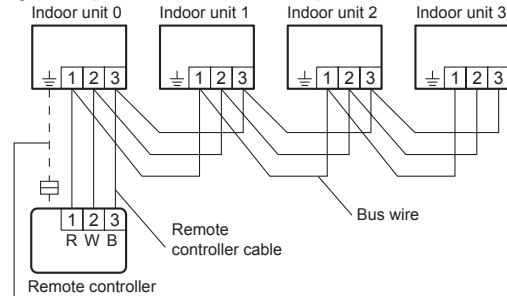

When earth (ground) wire is necessary

- Set the R.C. address (DIP switch setting)

Set the R.C. address of each indoor unit using the DIP switch on the indoor unit circuit board.

The DIP switch is normally set to 0.

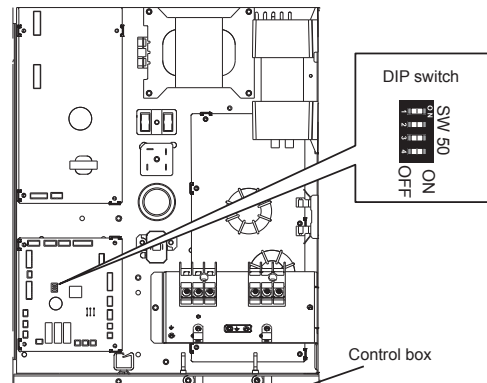

Set the R.C. address in accordance with the table below.

R.C. address	DIP switch			
	1	2	3	4
0	OFF	OFF	OFF	OFF
1	ON	OFF	OFF	OFF
2	OFF	ON	OFF	OFF
3	ON	ON	OFF	OFF
4	OFF	OFF	ON	OFF
5	ON	OFF	ON	OFF
6	OFF	ON	ON	OFF
7	ON	ON	ON	OFF
8	OFF	OFF	OFF	ON
9	ON	OFF	OFF	ON
10	OFF	ON	OFF	ON
11	ON	ON	OFF	ON
12	OFF	OFF	ON	ON
13	ON	OFF	ON	ON
14	OFF	ON	ON	ON
15	ON	ON	ON	ON

NOTE

Be sure to set consecutive R.C. address.
The indoor units cannot be operated if a number is skipped.

◆ Settings when simultaneous multi included.

- Set the refrigerant circuit address (Remote controller setting)
 - Turn on all of the indoor units.
Turn on the indoor unit with the R.C. address 00 last. (Within 1 minute)
 - Set the refrigerant circuit address. (Assign the same number to all of the indoor units connected to an outdoor unit.)

Refrigerant circuit address	Function Number	Setting Value
	02	00~15

- Set the "Primary" and "Secondary" settings. (Set the indoor unit that is connected to the outdoor unit using a transmission cable as the "Primary".)

	Function Number	Setting Value
Primary	51	00
Secondary		01

After completing the function settings, turn off all of the indoor units, and then turn them back on.

* If error code 21, 22, 24 or 27 is displayed, there may be an incorrect setting. Perform the remote controller setting again.

NOTE

When different indoor unit models are connected using the group control system, some functions may no longer be available.
If the group control system contains multiple units that are operated simultaneously, connect and set the units as shown below.

- Auto-changeover operates under the same mode with model R.C. address 00.
- It should not be connected to any other Gr that is not of the same series (A**G only).

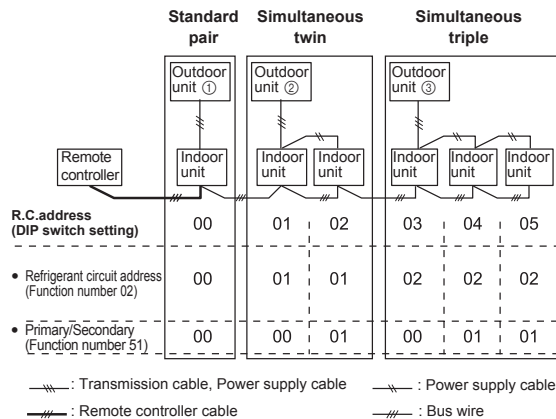

* Make sure that the indoor unit with the R.C. address 0 is connected to the outdoor unit using a transmission cable.

11. 2. Fan delay setting

This setting can be used when the auxiliary heater is mounted.
When the operation is stopped when the indoor unit is operating with an auxiliary heater, the operation continues 1 minutes.

- Jumper wire setting (indoor unit)
This setting is made by cutting the jumper wires on the circuit board of the indoor unit.

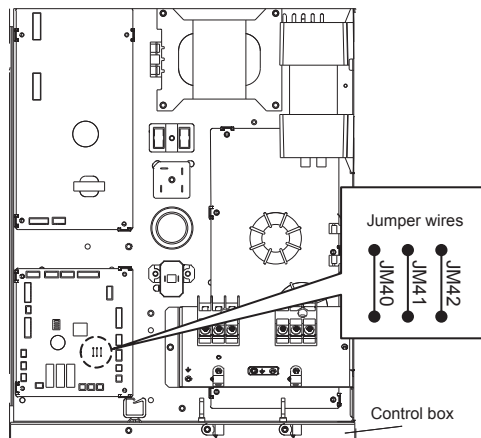

Jumper wire	JM state
JM 42	
Connect	Invalidity (Factory setting)
Disconnect	Validity

11. 3. Dual remote controllers

- Two separate remote controllers can be used to operate the indoor units.
- The timer and self-diagnosis functions cannot be used on the slave units.

- Wiring method (indoor unit to remote controller)

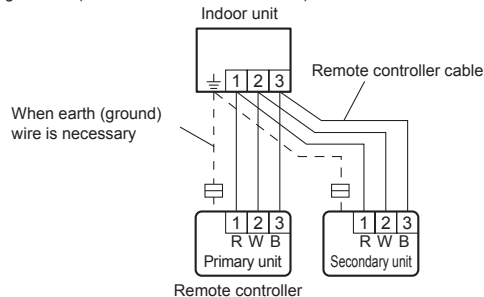

- Remote controller DIP switch 1 setting
Set the remote controller DIP switch 1 No. 2 according to the following table. (Refer to 7.2. Setting the dip switches)

	DIP SW 1-No. 2
Primary unit	OFF
Secondary unit	ON

12. OPTIONAL PARTS

WARNING

Regulation of cable differs from each locality, refer in accordance with local rules.

12. 1. External input and external output

Connection methods

- Wire modification
Use a tool to cut off the terminal on the end of the wire, and then remove the insulation from the cut end of the wire.
Connect the wire with connecting wire with solder.
Important: Be sure to insulate the connection between the wires.

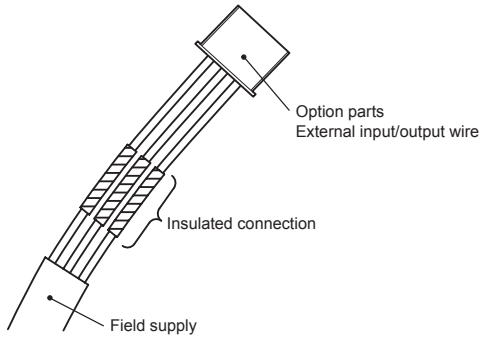

• Connection terminals

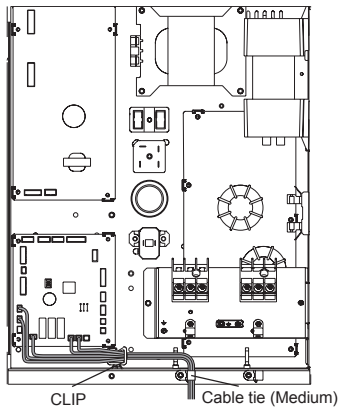
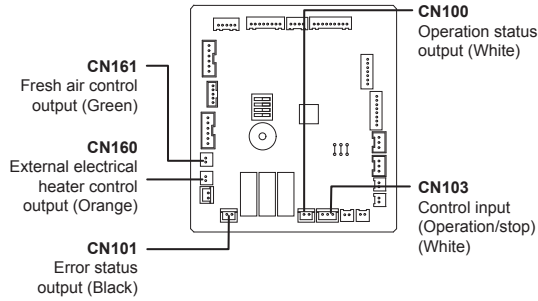

12. 2. I.R. receiver unit / Remote sensor

Connection method

• Connection terminals

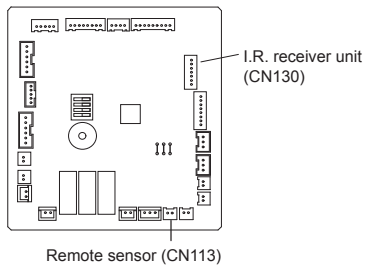

• Wiring arrangement

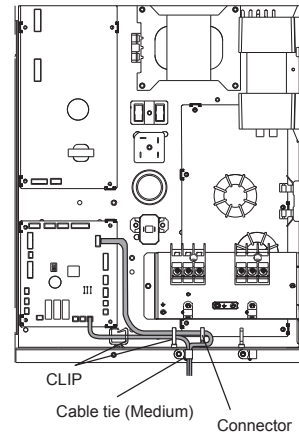

I.R. receiver unit

- Use 7 pins for I.R. receiver unit cable

Remote sensor

- Remove the existing connector and replace it with the remote sensor connector (ensure that the correct connector is used).
- The original connector should be insulated to ensure that it does not come into contact with other electrical circuitry.

Setting for room temperature control setting

When a remote sensor is connected, set the function setting of indoor unit as indicated below.

- Set Function Number "48" (Room temperature setting) to "01"

Setting for room temperature correction

When a remote sensor is connected, set the function setting of indoor unit as indicated below.

- Set Function Number "30" (Cooler air temperature correction) to "01"
- Set Function Number "31" (Heater air temperature correction) to "01"

13. CUSTOMER GUIDANCE

Explain the following to the customer in accordance with the operating manual:

- (1) Starting and stopping method, operation switching, temperature adjustment, timer, air flow switching, and other remote controller operations.
- (2) Air filter removal and cleaning, and how to use the air louvers.
- (3) Give the operating and Installation Manuals to the customer.
- (4) If the signal code is changed, explain to the customer how it changed (the system returns to signal code A when the batteries in the remote controller are replaced).

* (4) is applicable to using wireless remote control.

14. ERROR CODES

[Troubleshooting at the remote control LCD]

This is possible only on the wired remote control.

[Self-diagnosis]

- For the operation method, refer to the operating manual.
- When the error indication "E:EE" is displayed, follow the following items to perform the self-diagnosis. "E:EE" indicates an error has occurred.

R.C. address of INDOOR UNIT

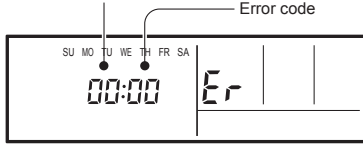

Ex. Self-diagnosis

Error display			Wired remote controller Error code	Mode	DESCRIPTION
OPERATION lamp (green)	TIMER lamp (orange)	ECO lamp (green)			
●(1)	●(1)	◇	11	Communication	Serial communication error
●(1)	●(2)	◇	12	Communication	Wired remote controller communication error
●(1)	●(5)	◇	15		Check run unfinished
●(2)	●(1)	◇	21		R.C. address or Refrigerant circuit address setting error [Simultaneous Multi]
●(2)	●(2)	◇	22	System	Indoor unit capacity error
●(2)	●(3)	◇	23		Combination error
●(2)	●(4)	◇	24		• Connection R.C. address error (indoor secondary unit) [Simultaneous Multi] • Connection R.C. address error (indoor unit or branch unit) [Flexible Multi]
●(2)	●(7)	◇	27		Primary unit, secondary unit set-up error [Simultaneous Multi]
●(3)	●(1)	◇	31	Indoor unit	Power supply interruption error
●(3)	●(2)	◇	32		Indoor unit PCB model information error
●(3)	●(5)	◇	35	Indoor unit	Manual auto switch error
●(3)	●(9)	◇	39	Indoor unit	fan motor driving circuit error.
●(4)	●(1)	◇	41	Indoor unit	Inlet air temp. sensor error
●(4)	●(2)	◇	42	Indoor unit	Indoor Heat Ex. Middle Temp. Sensor error
●(5)	●(1)	◇	51	Indoor unit	Indoor unit fan motor1 error
●(5)	●(3)	◇	53	Indoor unit	Drainage error
●(5)	●(7)	◇	57		Damper error
●(5)	●(9)	◇	59	Indoor unit	Indoor unit fan motor2 error
●(5)	●(15)	◇	5U	Indoor unit	Indoor unit error
●(6)	●(2)	◇	62	Outdoor unit	Outdoor unit model information error
●(6)	●(3)	◇	63	Outdoor unit	Inverter error
●(6)	●(4)	◇	64		Active filter error, PFC circuit error
●(6)	●(5)	◇	65	Outdoor unit	I.P.M. error
●(6)	●(10)	◇	6A		Display PCB microcomputers communication error
●(7)	●(1)	◇	71	Outdoor unit	Discharge temp. sensor error
●(7)	●(2)	◇	72	Outdoor unit	Compressor temp. sensor error

●(7)	●(3)	◇	73	Outdoor unit	• Heat Ex. centre temp. sensor error • Heat Ex. Liquid outlet temp. sensor error
●(7)	●(4)	◇	74	Outdoor unit	Outdoor temp. sensor error
●(7)	●(5)	◇	75		Suction Gas temp. sensor error
●(7)	●(6)	◇	76		• 2-way valve temp. sensor error • 3-way valve temp. sensor error
●(7)	●(7)	◇	77	Outdoor unit	Heat sink temp. sensor error
●(8)	●(2)	◇	82		• Sub-cool Heat Ex. gas inlet temp. sensor error • Sub-cool Heat Ex. gas outlet temp. sensor error
●(8)	●(3)	◇	83		Liquid pipe temp. sensor error
●(8)	●(4)	◇	84	Outdoor unit	Current sensor error
●(8)	●(6)	◇	86	Outdoor unit	• Pressure sensor error • High pressure switch error
●(9)	●(4)	◇	94	Outdoor unit	Over current error
●(9)	●(5)	◇	95	Outdoor unit	Compressor control error
●(9)	●(7)	◇	97	Outdoor unit	Outdoor unit fan motor1 error
●(9)	●(8)	◇	98	Outdoor unit	Outdoor unit fan motor2 error
●(9)	●(9)	◇	99	Outdoor unit	4-way valve error
●(9)	●(10)	◇	9A		Coil (expansion valve) error
●(10)	●(1)	◇	A1	Refrigerant system	Discharge temp. error
●(10)	●(3)	◇	A3	Refrigerant system	Compressor temp. error
●(10)	●(4)	◇	A4		High pressure error
●(10)	●(5)	◇	A5	Refrigerant system	Low pressure error
●(13)	●(2)	◇	J2		Branch boxes error [Flexible Multi]

Display mode ● : 0.5s ON / 0.5s OFF
◇ : 0.1s ON / 0.1s OFF
() : Number of flashing