

Callaway®
V



200s LASER RANGEFINDER



INTRODUCTION

Thank You for choosing the **Callaway 200 S Laser Rangefinder** featuring **P.A.T. (Pin Acquisition Technology)** and **Slope Mode**. Designed to deliver precise distance measurements, **P.A.T.** locks onto the flagstick up to 275 yards away, ensuring accuracy even when trees and other objects are in the background.

SPECIFICATIONS

Product	Callaway 200 S Laser Rangefinder
Model	200 S
Dimensions	3.74" x 2.80" x 1.57"
Weight	4.4 oz. (125g) (Without Battery)
Battery	CR2 3 -Volt Lithium Battery
Display	LCD display
Magnification	6X
Max Range	5-800 yd
Range To Flag	5-275 yd
Accuracy	+/- 1 yd
Slope Measurement Range	-89° - 90°
Unit of Measure	Yards/Meters
Water/Fog Proof	Weather Resistant (IPX3)

INCLUDES

A. CR2 - 3-Volt Lithium Battery

B. Carry Case

C. Cleaning Cloth

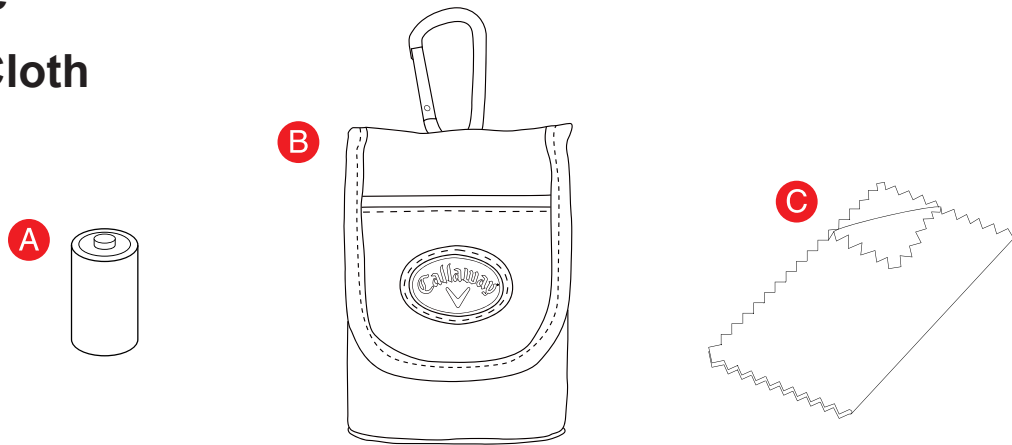

BATTERY INSTALLATION

1. Lift hatch tab.
2. Turn counterclockwise to open.
3. Remove protective plastic battery cover.
4. Replace battery cap & tighten by turning clockwise.

NOTE: If the **Low Battery Icon** is present on LCD display, there are approximately 200 ranges left until the battery is completely drained. The **Low Battery Icon** will flash if the battery life is very low. In this case, the battery needs to be replaced before next use.





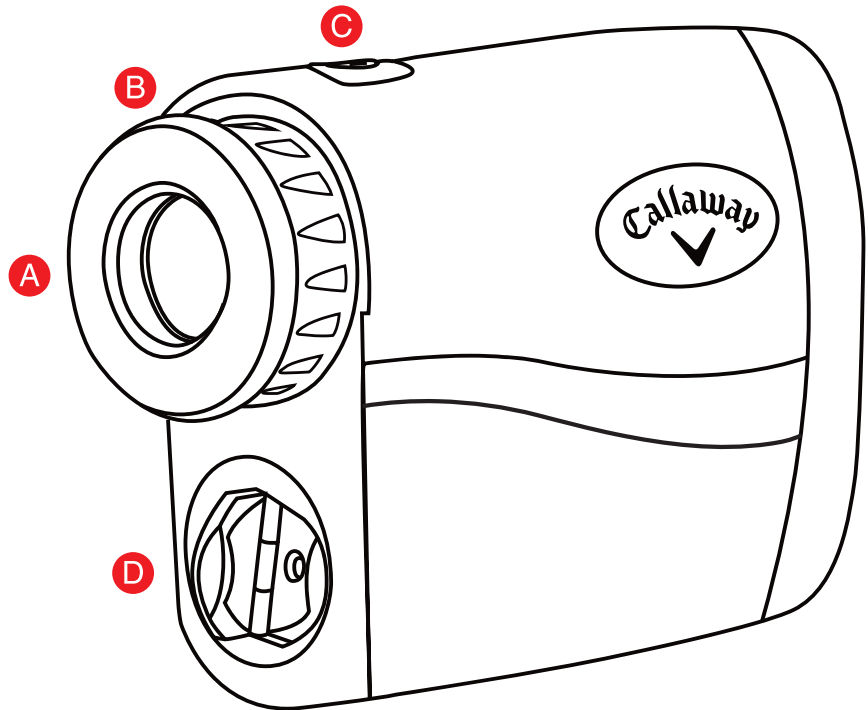

RANGEFINDER DIAGRAM

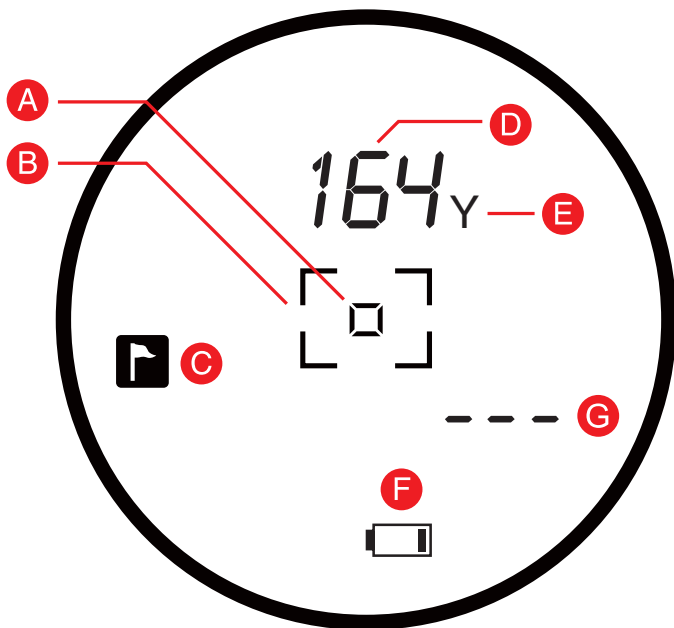
- A. Eye Piece
- B. Diopter Adjustment
- C. Power Button
- D. Battery Door



LCD DISPLAY



- A.  Zero-In Aiming Square
- B.  Laser Indicator Box
- C.  P.A.T. Mode Indicator
- D.  Distance
- E.  Unit of Measure
- F.  Low Battery
- G.  Slope Adjusted Distance

HOW TO USE

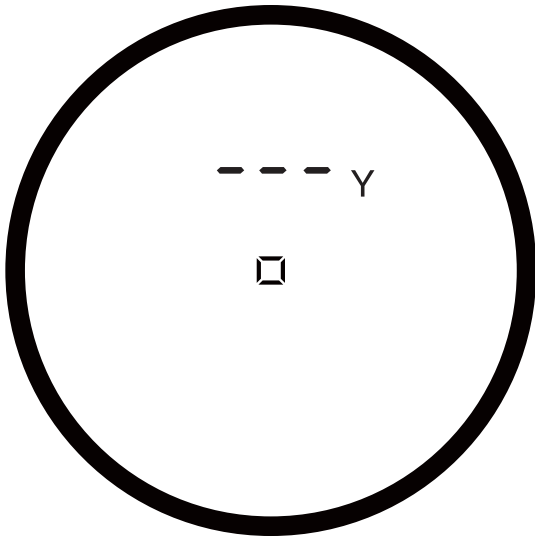

1. While looking through the **Eye Piece**, **PRESS** and **RELEASE** the **Power Button**. The rangefinder is now powered on.

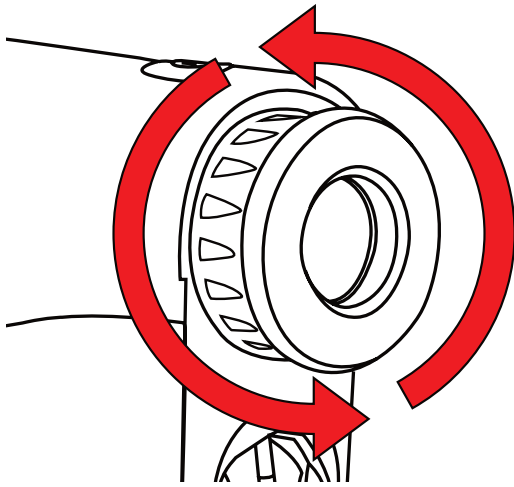

2. To focus/increase clarity, use the **Diopter Adjustment** by turning the **Eye Piece**.

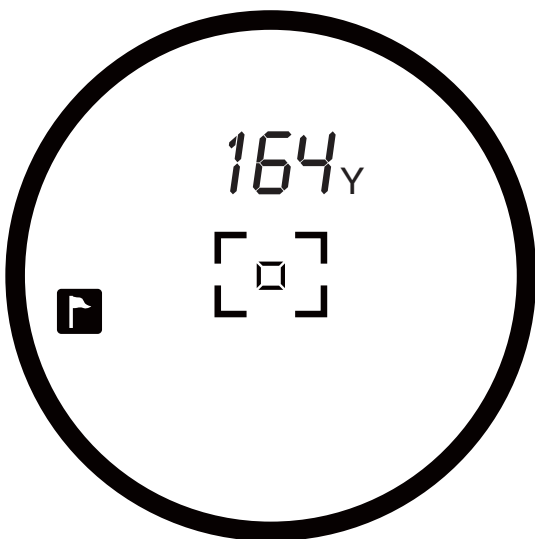

3. Continue looking through the **Eye Piece**, aim the **Zero-In Aiming Square** at your intended target and **PRESS** the **Power Button**. The laser will fire and the **Laser Indicator Box** will appear around the **Zero-In Aiming Square**. The measurement will be displayed at the top of the LCD display.

MEASUREMENT MODES

- 1. Standard** - Standard Mode is recommended when measuring distances to larger objects. (Fig. A)
- 2. P.A.T. (Pin Acquisition Technology)** - P.A.T. Mode is best used when measuring the distance to a flagstick or smaller objects. To toggle between Standard and P.A.T Mode, quickly **PRESS** the **Power Button Twice** while device is powered on. When P.A.T. Mode is activated, the flagstick icon will appear on the left side of the LCD display. (Fig. B)

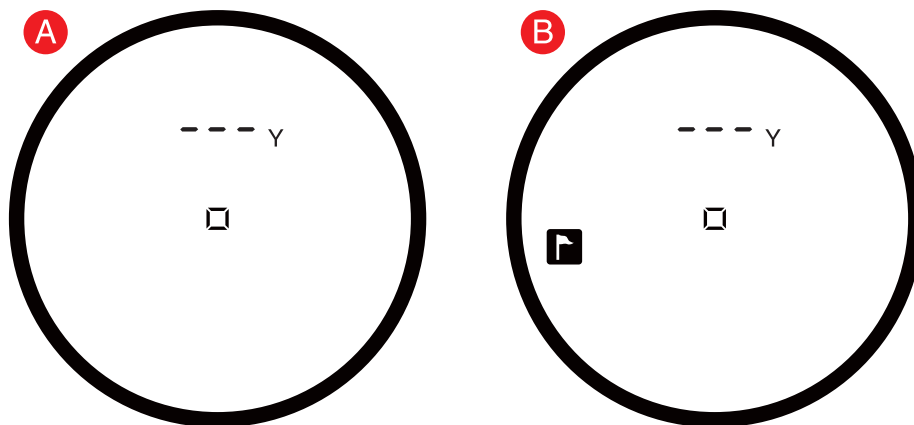

- 3. Scanning** - To measure distances to multiple targets in succession, **PRESS & RELEASE** the **Power Button** to power on. Then **HOLD** **Power Button**, the **Laser Indicator Box** will flash and the laser will continuously fire. Measurements will change as you scan the landscape and change targets.

NOTE: While scanning in P.A.T. Mode, the measurement will only change when a shorter distance is measured. This is useful when measuring the distance to a flagstick when there are trees or other objects in the background.

4. **Slope Mode** - Device will measure the angle of incline/decline (Fig. B) then calculate and display the slope adjusted distance in the bottom right of the LCD display. (Fig. C)

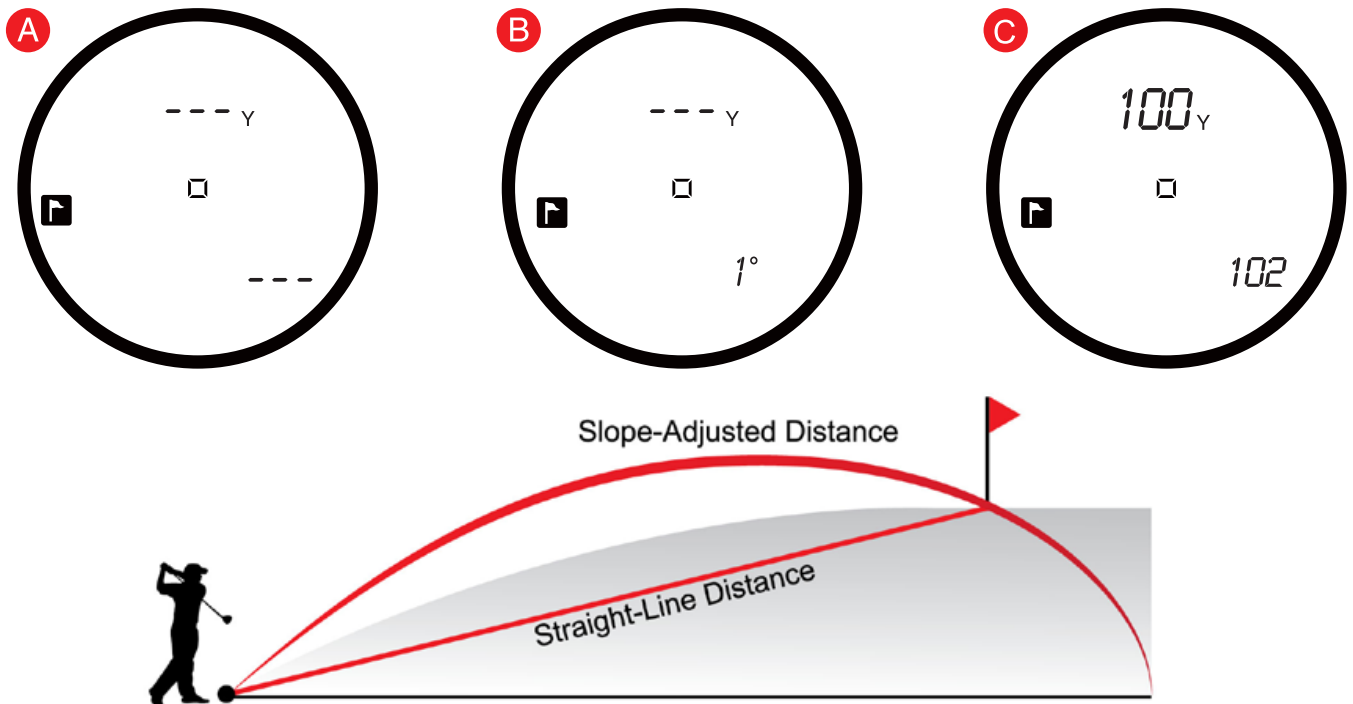

- **To turn Slope Measurement On/Off:**

NOTE: The slope measurement & adjusted yardage will appear in the bottom right corner of the LCD display when the function is enabled

1. With the unit off, **HOLD** the **Power Button** for **three seconds** until the slope function appears in the bottom right corner of the LCD display. Once the slope function appears, **RELEASE** the **Power Button**.
2. Repeat this process if you need to turn The Slope Measurement off. The Slope function will not appear unless enabled.

5. **Unit of Measure** - To change the unit of measure from Yards to Meters, start with the device powered off. Then **HOLD** the **Power Button** for 5 sec. The unit of measure is indicated by a "Y" or "M" shown directly to the right of the distance displayed.

OPERATIONAL NOTES

1. The maximum measurement range is 5-800 yards to objects and 5-275 yards to a flagstick with +/- 1 yard accuracy.

NOTE: Maximum range can depend on several factors, including target characteristics and environmental conditions. For instance, longer maximum distances may be obtained to targets that are large in size, brightly colored, or have a reflective finish. Ranging capability can also be affected by the angle to the target and lighting conditions.

2. **Auto Shutoff** - To conserve battery life, the device will automatically power off when idle for more than 5 seconds.
3. **Weather Conditions** - Heavy rain and thick fog can potentially limit the maximum range of the device.
4. **Weather Resistant** - Protected against light rain.

MAINTENANCE

1. To clean, use only a soft, clean cloth to prevent scratches.
2. Do not submerge in liquid or apply any cleaning products.
3. Do not store in extremely hot/cold temperatures (<50°F - >110° F).
4. Store in carrying case when not in use.

TROUBLESHOOTING

Rangefinder is consistently providing inaccurate measurements.

- Make sure the device is set to the desired unit of measure (Yards or Meters).
- Weak battery signal can affect the accuracy of the device. If the **Low Battery Indicator** is present on the LCD display, replace the battery.
- Make sure there isn't anything obstructing your view such as leaves, branches, your finger, etc.

TROUBLESHOOTING (CONTINUED)

When looking through the Eye Piece, the view is blurry.

- Use the Diopter Adjustment by turning the **Eye Piece** to focus/increase clarity.
- Make sure there isn't anything obstructing your view such as leaves, branches, your finger, etc.
- Use a soft, clean cloth to clean lens.

When should the battery be replaced?

- If the **Low Battery Indicator** is present on the LCD display.
- If the rangefinder is consistently providing inaccurate measurements.
- If the LCD display is not present when **PRESSING** the **Power Button**.

What type of battery does the rangefinder use?

- CR2 3-Volt Lithium Battery.

When should P.A.T. Mode be used?

- When measuring the distance to smaller targets such as a flagstick.
- When scanning the landscape to measure distances to a smaller target such as a flagstick and there are trees or other objects in the background.

***If you have any other questions or concerns,
please call 1-888-606-4634 or go to www.callawaydmd.com.***

WARRANTY POLICY

This product is warranted to be free from defects for up to (1) year from the original purchase date. IZZO Golf cannot refund your purchase unless purchased directly from IZZO Golf. IZZO Golf will replace or repair any unit that is determined defective under normal use within the warranty period. Please call Customer Service at **888-606-4634** to request a Return Authorization. All defective products must be returned to:

IZZO Golf
Attn: Returns Dept.
1635 Commons Parkway
Macedon, NY 14502

Please include a note with your Name, Address, Phone # and the Return Authorization #. Your replacement will be shipped once we diagnose the returned unit.

WARNING

- **NEVER** look directly into the sun or intense light when using the laser rangefinder.
- **DO NOT** aim/point laser rangefinder at another person.
- **DO NOT** aim/point laser rangefinder at anyone's eyes or face.
- **DO NOT** attempt to disassemble the laser rangefinder.
- **DO NOT** submerge in any liquid.
- **DO NOT** store the laser rangefinder in extreme cold/hot temperatures (<50°F - >110°F).



IZZO GOLF, INC.  
Tel:888-606-4634
1635 Commons Parkway Macedon, NY 14502
**CLASS 1 LASER PRODUCT INVISIBLE LASER
RADIATION AVOID DIRECT EXPOSURE**
Complies with FDA performance standards for laser
products except for deviations pursuant to Laser
Notice No. 50, dated June 24, 2007
905nm, Max <1mW

© 2018 CALLAWAY GOLF COMPANY. Callaway Golf and the Chevron device are trademarks of Callaway Golf Company. IZZO Golf is an official licensee of Callaway Golf Company.