

Steelcraft™

4 IN 1 PORTABLE COT

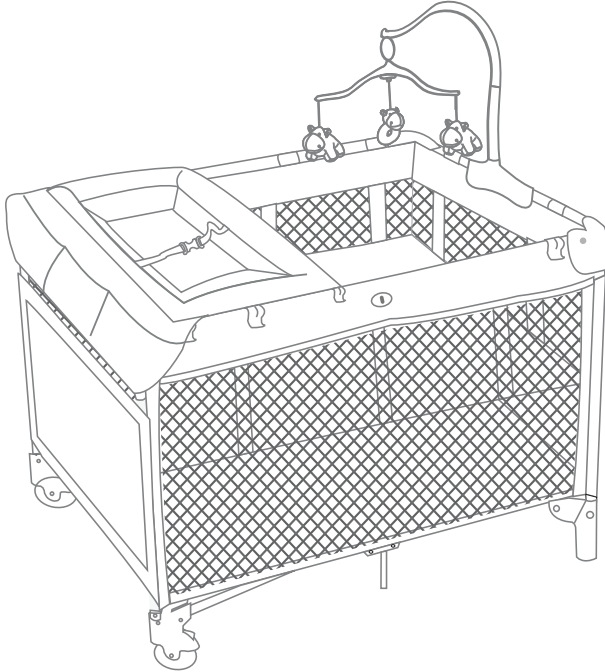

BEFORE ASSEMBLING THIS COT READ AND UNDERSTAND THE INSTRUCTIONS.

- Do not use mattress other than the one supplied by the manufacturer.
Incorrect mattress can cause death.
- Use only accessories as recommended by the manufacturers.
- Ensure the top rails and base are fully locked.
- Stop using this cot if any part of the cot is broken, torn or missing.

KEEP THESE INSTRUCTIONS IN A SAFE PLACE FOR FUTURE REFERENCE.

www.britax.com.au

SeriesY-835

WARNINGS

**ALWAYS FOLLOW THE MANUFACTURERS INSTRUCTIONS.
READ ALL INSTRUCTIONS CAREFULLY BEFORE ASSEMBLY AND USE
OF THIS COT.
THE CORRECT USE AND MAINTENANCE OF THIS PRODUCT IS
ESSENTIAL.**

WARNINGS: TO AVOID INJURY OR DEATH:

- FOLLOW THE MANUFACTURERS INSTRUCTIONS.
- MAKE SURE CHILDREN ARE KEPT AWAY WHILE YOU ARE ASSEMBLING/ DISASSEMBLING THE COT.
- ALWAYS APPLY THE BRAKES WHEN USING THE COT.
- DO NOT LEAVE YOUR CHILD UNATTENDED.
- USE ONLY THE MATTRESS SUPPLIED BY THE MANUFACTURER, INCORRECT MATTRESSES CAN CAUSE DEATH.
- DO NOT ADD ANY EXTRA MATTRESSES AS IT MAY CAUSE SUFFOCATION & DEATH.
- TO PREVENT FALLS THE BASSINET MUST NOT BE USED ONCE A CHILD CAN SIT UP.
- NEVER PLACE A CHILD IN THE COT WHEN THE BASSINET IS IN PLACE.
- NEVER PLACE A CHILD IN THE COT WHEN THE CHANGE TABLE IS IN PLACE.
- ALWAYS USE THE HARNESS WHEN USING THE CHANGE TABLE.
- REMOVE THE TOY MOBILE FROM THE COT WHEN THE CHILD BEGINS TO PUSH UP ON HANDS AND KNEES.
- Check that the assembly of the cot is correct and safe.
- Check that all folding parts and locking devices are fully engaged before placing child in the cot.
- Do not place more than one child in the cot at the same time.
- Check that the assembly of the cot is correct and safe.
- Check that all folding parts and locking devices are fully engaged before placing child in the cot.
- Do not place more than one child in the cot at the same time.

WARNINGS

WARNINGS

- Do not use your cot if any part is torn, broken or missing.
- Do not place toys or other objects in the cot which could provide a step or foothold to help the child climb out.
- Cots with padded rails should not be used if the covering fabric has been bitten through.
- Do not use or leave the cot near open fires, naked flames, electric bar fires, gas fires, stoves, heaters or barbecues.
- Do not place the cot where your child could reach medication, money, string, elastic, small toys or other small objects.
- Do not place the cot near trailing or hanging cords, leads or flexes such as curtain cords, electrical cords or leads, etc.
- The thickness of the mattress has been specified to ensure that the distance from the top of the mattress to the top of the lowest side or end will always be at least 500mm. This will reduce the risk of the child falling out of the cot.
- Using the wrong size mattress may create hazardous gaps that could result in suffocation or could reduce the side height of the cot, which may result in your child falling out of the cot.
- Do not use parts or accessories other than those tested and approved by Nursery Elegance.
- Do not use this cot with a child who can climb out, weighs more than 15kg, or is taller than 90cms.
- Always check parts regularly for tightness of screws, nuts and other fasteners - tighten if required.

THIS PRODUCT IS NOT INTENDED FOR COMMERCIAL USE.

WARNINGS

WARNING: MATTRESS SIZE

Using the wrong size mattress may create hazardous gaps that could result in suffocation or could reduce the side height of the cot which may result in your child falling out from the cot.

IMPORTANT

To ensure the cots correct assembly and use, ensure you follow these instructions in the order they are written.

TESTED AND APPROVED ACCESSORIES

Mattress by Steelcraft - Series Y-835M

Bassinet by Steelcraft - Series Y-835M

Change Table by Steelcraft - Series Y-835M

Toy Mobile by Steelcraft - Series Y-835M

PARTS LIST



A 1 x Carry Bag



B 1 x Mattress

PARTS LIST

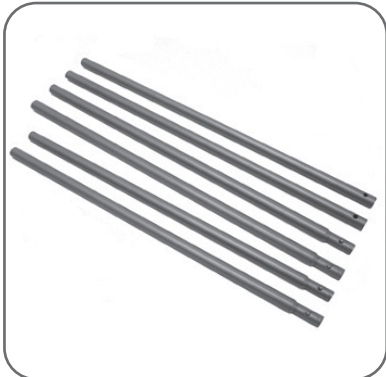

C 6 Mattress Support Rods



D 1 x Cot



E 1 x Bassinet



F 1 x Change Table



G 1 x Toy Mobile Stand
& 3 Soft Toys (4 in 1 model only)

1. TO OPEN THE COT



IMPORTANT: THESE STEPS WILL ENSURE THAT THE COT IS CORRECTLY OPENED AND READY TO USE.

- A Unzip the carry bag and remove the cot.
- B Stand the cot on its feet and undo the hook & loop straps that hold the mattress around the frame.
- C Remove the mattress and set it aside.
- D Separate the legs of the cot.

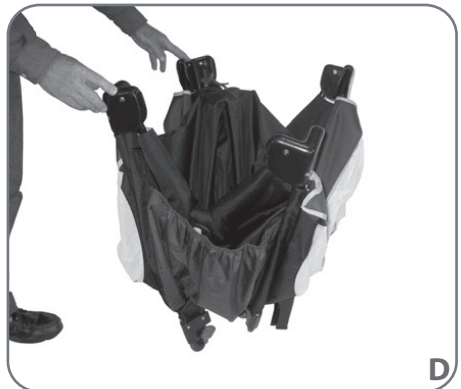
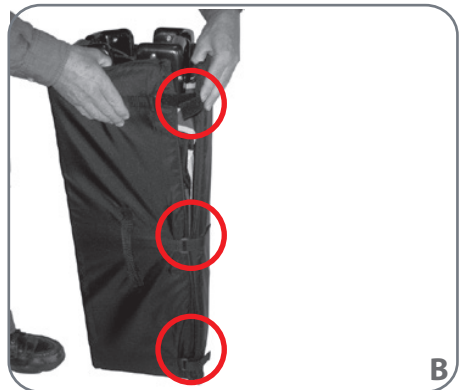

1. TO OPEN THE COT



CAUTION: TAKE CARE, AS FINGER PINCHING CAN OCCUR IN THE CORNER WHEN LOCKING THE RAILS IN PLACE.

- E** Starting with the short rails, pull the centre up with both hands quickly until they are locked in place.
- F** Now do the same with the longer rails.



PLEASE NOTE: All top rails should be locked in place. If they are not, release them and try again. The centre of the cot base must be in a raised position to allow the rails to lock easily. Check for the secure engagement of the rails by pushing down on them.

- G** Holding one end of the cot clear of the ground, gently press down in the middle of the base until the base lays down flat. The base should now be locked into position.

1. TO OPEN THE COT



H Place the mattress into the cot with its padded side facing up.

I Secure the mattress to the cot by passing the loop straps through the slots in the cot base and pressing it onto the hook attachment strips, sewn to the underside of the cot base.

PLEASE NOTE: Always secure the mattress before using the cot.

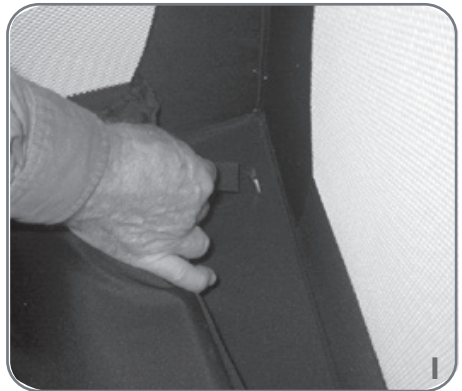

2. TO USE THE WHEELS

A Push the brake lever down to lock, or lift the brake lever up to unlock.

PLEASE NOTE: Always apply the brakes wherever and whenever you are using the cot.

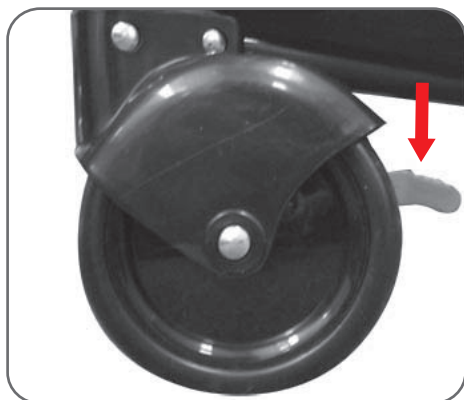

Push down to lock



Lift up to unlock

3. TO FOLD THE COT

! **IMPORTANT:** THESE STEPS MUST BE FOLLOWED IN THIS ORDER TO EASILY FOLD THE COT.

- A** Release the loop straps under the base that secure the mattress and remove the mattress from the cot.
- B** Pull the strap up in the middle of the base all the way up.
- C** Release each top rail by lifting the rail slightly and squeezing on the buttons, located under the centre joint.
- D** Ensure that each rail is fully released and then pull all the way up on the cot base strap, while gathering the legs and the frame together until its fully folded.

3. TO FOLD THE COT

- E** Take the mattress and wrap it around the folded cot with the padded side facing inwards.
- F** Thread the straps through the plastic loops, pull them tight and secure using the hook and loop attachments.
- G** Take the carry bag and cover the folded cot. Finish covering the cot ensuring the mattress handle is through the opening then close the zipper.

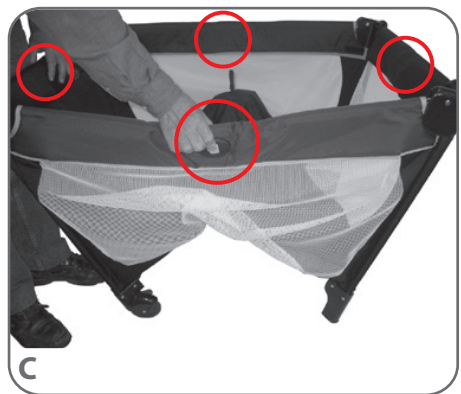

IF THE TOP RAILS DO NOT FOLD - DO NOT FORCE THEM - LIFT THE BASE HIGHER AND RE-SQUEEZE THE BUTTONS TO FULLY RELEASE THEM.



DISASSEMBLE AND STORE THE BASSINET AND CHANGE TABLE IN THE CARRY BAG.

4. TO USE THE BASSINET



WARNINGS: TO PREVENT FALLS, THIS BASSINET SHOULD NOT BE USED ONCE A CHILD CAN SIT UP. NEVER PLACE A CHILD IN THE COT WHEN THE BASSINET IS IN PLACE.

- A** Insert the 3, two piece support rods into bassinet inner sleeves separately and engage them in the middle with the locking pin.
- B** Insert the mattress and secure it to the bassinet by passing the loop straps through the slot in the bassinet base, then press the loop straps onto the hook attachment, sewn to the underside of the bassinet.

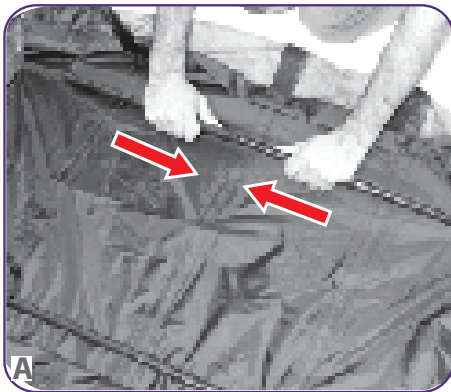

- C** Lower the bassinet into the cot and snap the 12 plastic clips onto the top rails of the cot. Make sure the plastic clips are positioned against the edge of the corner mouldings.

4. TO USE THE BASSINET



PLEASE NOTE: Always secure the mattress before using the bassinet.



IMPORTANT: ALWAYS REMOVE THE BASSINET BEFORE FOLDING THE PORTABLE COT.

5. TO USE THE CHANGE TABLE



WARNINGS: NEVER LEAVE YOUR CHILD UNATTENDED.

TO PREVENT FALLS THE CHANGE TABLE SHOULD NOT BE USED ONCE A CHILD CAN SIT UP.

NEVER PLACE A CHILD IN THE COT WHEN THE CHANGE TABLE IS IN PLACE.

ALWAYS USE THE HARNESS WHEN USING THE CHANGE TABLE.

- A** Lay the change table face down with the four plastic hooks facing up.
- B** Connect the tubes together on either side of the change table. Insert one tube end into the other until the pin engages. Pull on the tubes to make sure they are locked together.
- C** Pick the change table up by the plastic hooks and connect to the outside of the portable cot short end rail as shown. +
- D** Rotate the change table over the portable cot and engage each of the four clamps onto the side rails. Move the bassinet clamps slightly if they interfere with the attachment of the change table.
- E** Pull the pocket flap over the end of the portable cot. Attach the plastic clamps to the leg tubes to keep the pocket in place.
- F** When the change table is not in use, always fold over the end rail until required again.
- G** To remove the change table, release the plastic hooks from the top rails.

5. TO USE THE CHANGE TABLE

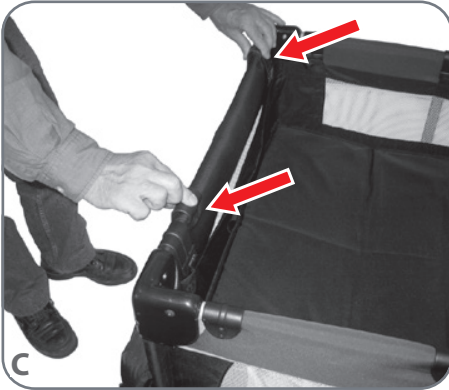

PLEASE NOTE: Make sure the four clamps are engaged on to the side rails.

6. TO ASSEMBLE AND USE THE TOY MOBILE (4 in 1 Portable cot model only)

! WARNING: POSSIBLE ENTANGLEMENT INJURY: THIS MOBILE IS DESIGNED TO BE USED FROM BIRTH TO 5 MONTHS. A MOBILE IS INTENDED FOR VISUAL STIMULATION AND IS NOT INTENDED TO BE TOUCHED BY THE CHILD. KEEP OUT OF THE BABY'S REACH. DO NOT PLACE YOUR CHILD DIRECTLY UNDER THE MOBILE. REMOVE MOBILE FROM THE COT WHEN BABY BEGINS TO PUSH UP ON HANDS AND KNEES. DO NOT ADD ADDITIONAL STRINGS OR STRAPS TO ATTACH TO A CRIB OR PLAYPEN.

! WARNING: ALWAYS ATTACH THE MOBILE SECURELY TO THE COT ACCORDING TO THESE INSTRUCTIONS. CHECK ATTACHMENT FREQUENTLY.

A Insert the mobile upper curved arm into the mobile lower arm until locked together.

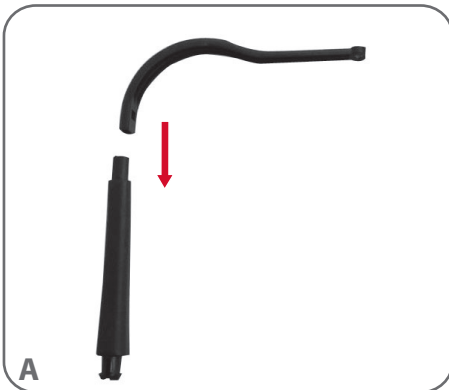

6. TO ASSEMBLE AND USE THE TOY MOBILE

B Insert the connector on the round music box into the hole on the mobile hanger and push until they lock together.

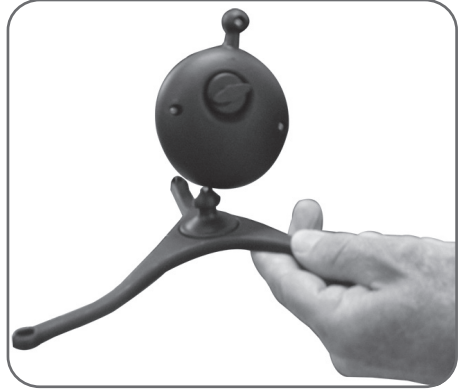

C Snap the moulding on the top of the music box into the end of the upper curved arm. Push the assembled mobile into the hole in the base moulding. Make sure it fully snaps in by pulling up the arm to check if they are securely attached.



6. TO ASSEMBLE AND USE THE TOY MOBILE

- D** Connect each of the three toys to the mobile tri-shaped hanger by threading the string into the slot at the end of each hanger arm.

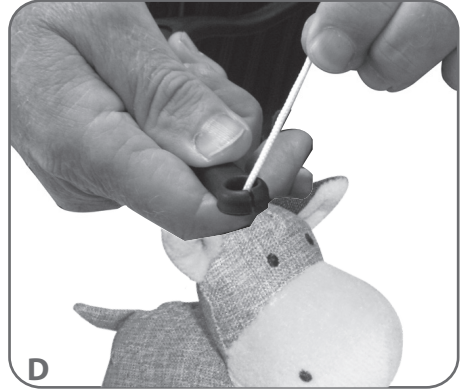
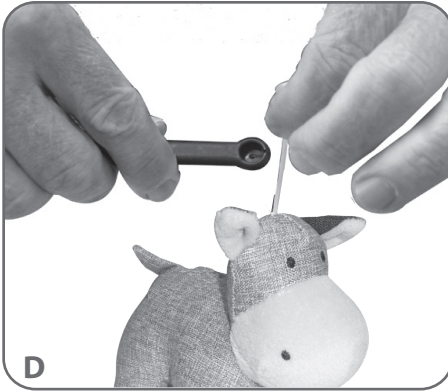

- E** The mobile can be fitted to the cot with or without the bassinet. To attach the mobile push the base of the mobile over any of the cot top rail centre joints. If using the change table, ensure the toy mobile is fitted at the opposite end.

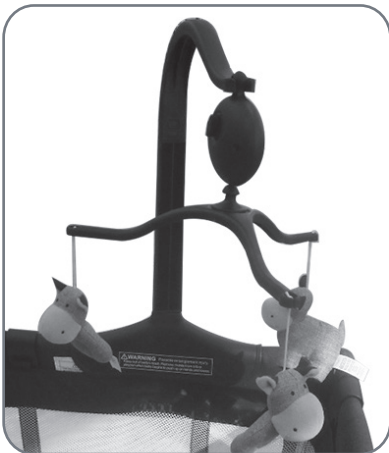

6. TO ASSEMBLE AND USE THE TOY MOBILE

F To operate the music box turn the winder on the back of the box clockwise.

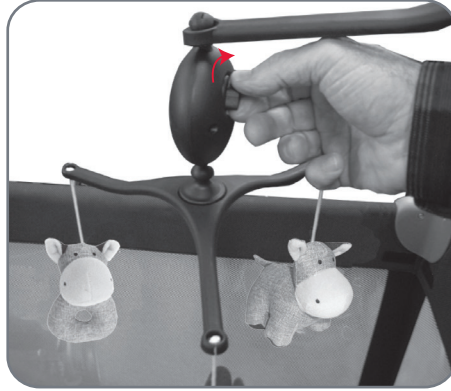

CARE & MAINTENANCE

- To prolong the life of your cot keep it clean and do not leave it in the direct sunlight for extended periods of time.
- Removable fabric covers and trims may be cleaned using warm water with a household soap or mild detergent. Allow it to dry fully, preferably away from the direct sunlight.
- Non removable fabric covers and trims may be spot cleaned using a damp sponge with soap or a mild detergent. Allow it to dry completely before folding or storing it away.
- **DO NOT DRY CLEAN OR USE BLEACH.**
- Do not machine wash, tumble or spin dry, unless care labeling on the product permits these methods.
- In some climates the covers and trims may be affected by mould and mildew. To help prevent this occurring, do not fold or store the product if damp or wet. Always store the product in a well ventilated area.
- Regularly inspect and maintain you product to ensure the freedom of movements of the locking devices and security of components. To maintain the safety of your nursery product, seek prompt repairs for bent, torn, worn or broken parts.



WARNING: IF THE SIDES DO NOT LATCH FIRMLY OR THERE ARE HOLES IN THE MESH SIDES, DISCONTINUE USE IMMEDIATELY AND SEEK REPAIR.

THIS PRODUCT IS NOT INTENDED FOR COMMERCIAL USE.

SteelcraftTM

BRITAX CHILDCARE PTY. LTD.
A.B.N. 55 006 773 600
Level 4, 650 Lorimer Street, Port Melbourne, Victoria 3207, Australia
Phone: (03) 9288 7288 Fax: (03) 9311 5798

CUSTOMER SERVICE
1300 303 330 - Australia 0508 688 822 - New Zealand

Due to our continuing program of development, Britax reserves the right to alter the specifications, color or design without any further notice.

The Steelcraft trademark is the property of Britax Childcare Pty.Ltd - Australia.

The Britax trademark is the property of Britax Childcare Holdings Limited - UK.

Visit the Britax website at: www.britax.com.au or email us at au-custserv@britax.com

Due to the variations in the style and design of our products the illustrations used in this instruction booklet are generic.

This product is designed to comply with Australian and New Zealand standard AS/NZS 2195:2010+Amendment No.1:2013+Amendment No.2:2015.

©2018 Copyright Britax Childcare Pty. Ltd. Australia

www.britax.com.au

Art No. 4002156/B